

**SUPPLY**

**AND**

**ERECTION OF GATES**

**CHAPTER – 26****GATES****C O N T E N T S**

	<b>Contents</b>	<b>Page Nos.</b>
26.1	References	26-1
26.2	General	26-4
26.2.1	Classification of Gates	26-4
26.2.2	Type of Gates	26-4
26.2.3	Components & Material Specifications	26-5
26.2.4	Design Criteria	26-5
26.2.5	Typical Installation of Gates	26-6
26.3	Scope	26-7
26.4	General Specifications for Workmanship, Welding, Riveting, Finishing, Painting of Steel Structures	26-8
26.4.1	Straightening	26-8
26.4.2	Cutting	26-8
26.4.3	Holing	26-8
26.4.4	Riveting	26-9
26.4.5	Bolting	26-9
26.4.6	Welding	26-9
26.4.7	Casting & Forgings	26-10
26.4.8	Tolerances	26-11

	<b>Contents</b>	<b>Page nos.</b>
26.4.9	Painting	26-11
26.5	Fixed Wheel & Slide	26-12
	Gates- Manufacture	
26.5.1	General	26-12
26.5.2	Materials	26-12
26.5.3	Welding	26-13
26.5.4	Manufacturing Tolerances	26-13
26.5.5	Shop assembly & Testing For Gates & Embedded parts	26-15
26.5.6	Painting	26-15
26.6	Fixed wheel and slide Gates – Rope Drum Hoist	26-16
26.6.1	General	26-16
26.6.2	Materials	26-16
26.6.3	Hoist, Unit of Gates And Checking	26-17
26.6.4	Lubrication of Gears And Bearings	26-18
26.6.5	Inspection of Hoist Assembly And Checks	26-19
26.7	Fixed Wheel And Slide Gates- Erection	26-19
26.7.1	General Inspection	29-19
26.7.2	Inspection of Block Outs	26-20

	<b>Contents</b>	<b>Page Nos.</b>
26.7.3	Inspection of Embedded Parts	26-20
26.7.4	Inspection of the Gates at site of Erection	26-22
26.8	Fixed Wheel And Slide Gates- Inspection of Complete Gate Installation	26-23
26.9	Fixed Wheel And Slide Gates-  Testing	26-24
26.12	Fixed wheel and slide gates- Rope Drum Hoist	26-26
26.12.1	General	26-26
26.12.2	Material	26-26
26.12.3	Hoist unit of gate  and checking	26-26
26.12.4	Lubrication of gears  And bearings	26-28
26.12.5	Inspection of hoist  Assembly and checks	26-28
26.12.6	General Inspection	26-29
26.12.7	Inspection of Pier Anchorages	26-30
26.12.8	Inspection Sill Beam	26-33
26.12.9	Inspection of Wall Plates	26-33
26.12.10	Inspection of Gates	26-33
29.12.11	Inspection of Gate Installation (Complete) with Hoist Including Electrical Item.	26-34

<b>Contents</b>		<b>Page Nos.</b>
26.12.12	Testing	26-35
26.13	Single Faced Shrice Gate	26-36
26.13.1	General	26-36
26.13.2	Classification	26-37
26.13.3	Materials	26-38
26.13.4	Manufacture and Workmanship	26-38
26.13.5	Door	26-38
26.13.6	Face (door) and seat (frame) rings	26-39
26.14.1	Guides	26-39
26.14.2	Spindles	26-40
26.14.3	Operating mechanism	26-40
APPENDIX – A	Materials for the Components of Fixed- Wheel Gates	26-42
APPENDIX – B	Recommended Materials for Various Components (For Low Head Slide Gates)	26-45
APPENDIX – D	Tolerances for Embedded Part and In Components of Gate. (For Fixed Wheel And Low Head Slide- Gates)	26-47
APPENDIX – F	Specification for Rubber For Seal.	26-50
Plate -	26-P/ 1 to 26-P/ 8	26-51 to 26-58

## CHAPTER – 26

### GATES

#### 26.1

#### REFERENCES

- IS : 210-1978 Specifications for gray iron casting. (Reaffirmed in 1991)
- IS : 226-1975 Specifications for structural steel. (Standard quality)  
( Superceded by I.S. 2062-1992 )
- IS : 306-1983 Specifications for Bronze in gates & casting.  
(Reaffirmed in 1988)
- IS : 318-1962 Specifications for loaded Tin Bronze & casting.  
(Revised in 1981 And reaffirmed in 1991)
- IS : 800-1962 Code of practice for use of structural steel in general  
building  
Constructions. (Revised in 1984 and reaffirmed in 1991)
- IS : 808-1973 Specifications for rolled steel beam, channel and angle  
sections.  
(Pt. III, V & VI) (Revised in 1989)
- IS : 816-1956 Code of practice for use of Metal Arc Welding for  
general  
Construction in Mild Steel. (Reaffirmed in 1992)
- IS : 817-1987 Code of practice for Straining and testing of metal arc  
Welders. (Reaffirmed in 1991)
- IS : 819-1957 Code of practice for resistance spot welding for light  
Assemblies in Mild steel. (Reaffirmed in 1992)
- IS : 822-1970 Code of practice for inspections of welds. (Reaffirmed  
in 1991)
- IS : 823-1964 Code of procedure for Metal Arc Welding of Mild steel.

IS : 1024-1968	Code of practice for use of welding in Bridges and structures. Subject to dynamic loading. (Revised in 1979 and Reaffirmed in 1992)
IS : 1030 – 1982	Carbon steel castings for general engineering purposes. (Revised in 1989)
IS : 1068 – 1976	Specifications for carbon steel castings for general engineering Purpose. (Revised in 1985 and Reaffirmed in 1991)
IS : 1068-1968	Electroplated castings of Nickel & Chromium Iron & Steels . (Revised in 1985 and Reaffirmed in 1991)
IS : 1181 – 1967	Qualifying test for Metal Arc Welders. (Superceded By 7318 - 1974)
IS : 1323-1959	Code of practice for Oxygen- Acetylene welding for structural Work in Mild steels. (Revised in 1982 and Reaffirmed in 1987)
IS : 1393-1961	Code of practice for training & testing of oxygen Acetylene Welding. (Reaffirmed in 1991)
IS : 1570-1961	Schedule for wrought steels for general engineering purposes. (Reaffirmed in 1987)
IS : 2004-1978	Specifications for steel forgings for general engineering purposes. (Revised in 1991)
IS : 2062-1980	Specifications for structural steel. (Fusion Welding quality) Revised in 1992
IS : 2595-1978	Code of practice for Radiographic Testing. (Reaffirmed in 1991)
IS : 2825-1969	Code of practice for stress relieving of welding joints. (Reaffirmed in 1984)
IS : 3042-1965	Specifications for single faced sluice gates. (200 mm to 1200 mm size)

IS : 4622-1978	Recommendations for structural design of fixed wheel gates. (Revised in 1992)
IS : 4623-1984	Recommendations for structural design for Radial gates. (Reaffirmed in 1990)
IS : 5620-1978	Recommendations for structural design for low head slide gates. (Revised in 1985 and Reaffirmed in 1990)
IS : 5905-1970	Specifications for sprayed aluminum and zinc coating on iron & steel. (Revised in 1989)
IS : 6527-1972	Specifications for stainless steel Rods. (Reaffirmed in 1992)
IS : 6603-1972	Specifications for steel bars and flats. (Reaffirmed in 1991)
IS : 7718 (Pt. I) – 1975	Recommendations for inspection testing and maintenance of fixed wheel and slide gates at manufacturing stage. (Revised in 1991)
IS : 7718 (Pt. II)- 1978	-do- at the time of erection. (Revised in 1991)
IS : 7718 (Pt. III)-1978	-do- after erection. (Revised in 1991)
IS : 8500-1977	Weldable structural steels medium and higher strength quality. (Revised in 1992)
IS : 9349-1979	Recommendations for Structural design of Medium and high Head Slide gates. (Revised in 1986 and Reaffirmed in 1991)
IS : 10096 (Pt. I, Sec.I)- 1963	Recommendations for inspection, testing, maintenance of radial gates and their heights at manufacturing stage, (Revised in 1983 and Reaffirmed in 1990)
IS : 10096 (Pt. III)-1982	-do- after erection. British Steel Corpn. Corrosion prevention booklet No.5. (Revised in 1992)
IS : 10210 – 1982	Specifications for hydraulic Hoist.



**26.2 GENERAL****26.2.1 Classification of Gates**

The gates shall be classified on the basis of water head above the sill level as below :

- a) High head gates- A gate which operates under a water head of 30 M and above.
- b) Medium head gates – A gate which operates above a water head of 15 M but less than 30 M.
- c) Low head gates – A gate which operates under a water head of less than 15 M.

**26.2.2 Types of Gates**

Under all water head conditions, different types of gates under use in river valley projects shall be of following types :

- (a) Slide gates
- (b) Fixed wheel gates
- (c) Stoney or roller gates
- (d) Caterpillar gates
- (e) Radial gates
- (f) Single faced Sluice gates

**Vertical Lift Gates**

- (a) Slide gates
- (b) Fixed wheel gates
- (c) Stoney or roller gates
- (d) Caterpillar gates

Radial gates or Tainter Gates

### **Spillway gates**

#### ***Gates for Hydropower Purposes***

- (a) Penstock or Conduit Gates
- (b) Draft Tube Gates
- (c) Bulk Head Gates

#### ***Stop logs or Guard Gates***

#### **26.2.3 Components & Material Specifications for different gates.**

The materials to be used in the fabrication/manufacture of gates shall conform to relevant latest Indian Standards. For other items viz. castings/forging, manufacturers test certificates shall be checked to ensure quality, if prescribed by the department. For bought out items viz. motor, wire ropes, bearings, bushings, seals etc. department shall specify in advance the required quality standards. The general components of various gates shall have following material qualifications.

- (a) For fixed wheel gats - As per Appendix A
- (b) For slide gates - As per Appendix B
- (c) For radial gates - As per Appendix C

#### **26.2.4 Design Criteria**

The general design consideration for all kinds of gate, lays down that

- (a) The gate shall be self closing type under its own weight
- (b) The gate shall be power operated or manually operated (if provided)
- (c) In case of regulation requirement, the gate shall be capable of being held in partially open position without cavitation and under vibration.
- (d) The gate should be reasonably water tight within the specified limits of 5 to 10 lit/minute/meter length of seal.

Following Indian Standards shall be referred for design aspects of various gates:

- (a) Fixed wheel gates - IS : 4622-1992
- (b) Slide gates - IS : 5620-1978
- (c) Radial gates - IS : 4623-1990
- (d) Single faced sluices gates (200-1200mm) - IS : 3042-1965

### 26.2.5 Typical installation of various types of gates.

Following diagrams showing the typical installation of various types of gates are given :

- Fig 1 : Typical arrangement of various components of fixed wheel gates  
(Ref. Para 26.7.3.7 also)
- Fig. 2 A Typical diagram showing low head slide gates (full face gates frame)
- Fig. 2 B typical diagram showing low head slide gates leaf.
- Fig. 2 C Typical diagram showing embedded frame of low head slide gate.
- Fig. 2 D Low head slide gate showing gate & frame.
- Fig. 2 E Low head slide gate sealing arrangement (stop log with rubber seal).
- Fig. 2 F Low head slide gate sealing arrangement (stop log with wood seal)
- Fig. 2 G Low had slide gate (with rubber & wood seal)
- Fig. 3 A Radial gate with parallal arm.
- Fig. 3 B. Radial gate with inclined arm.
- Fig. 3 C Provision for elongation in anchors.

Fig. 4 A.	Dimensions of single faced sluices 200 mm to 600 mm (rising type).
Fig. 4 B	Dimensions of single faced sluices 200 to 600 mm (non-rising type).
Fig. 4 C	Dimensions of single faced sluices 200 mm to 1200 mm (rising type).
Fig. 4 D mm	Dimensions of single faced sluices 200 mm to 1200 mm (Non- rising type)
Fig. 4 E	Dimensions of single faced sluices 300x375 mm to 1050 x 1200 mm (rising type)

### 26.3 SCOPE

The scope of the specification laid down herein after is to make recommendations and issue guide lines in respect of hydraulic structures used on river valley projects for controlled releases of water. These gates are the steel structures and are manufactured through standard codes of practices involving selection of materials, fabrication under specified tolerance by welding/riveting inspection of manufactured assemblies and their accuracies, erection of gate components through embedment, with the help of embedded parts, into the civil structures and finally testing the installation and final checks involved.

Following stages have been discussed in these specifications in all types of gates :

- (a) General workmanship.
- (b) Manufacture/fabrication of gate structure/ components, embedded parts.
- (c) Shop assembly.
- (d) Erection- Inspection & Testing

## **26.4 General specifications for workmanship, welding/riveting finishing & painting of steel structures (Gates).**

### **26.4.1 Straightening**

All materials shall be straight and if necessary before being worked shall be straightened and or flattened by pressure, unless required to be of curvilinear form and shall be free from twists.

### **26.4.2 Cutting**

26.4.2.1 Cutting may be affected by shearing, chopping or sawing. Gas cutting by mechanically controlled torch shall be permitted for mild steel only. Gas cutting of high tensile steel shall also be permissible provided special care is taken to leave sufficient metal to be removed by machining so that all metals that has been hardened by flame is removed. Hand flame cutting shall be permitted subject to the approval of purchaser.

26.4.2.2 Shearing, Chopping and gas cutting shall be clean, reasonably square and free from distortion. The edges shall be grounded afterwards if considered necessary.

### **26.4.3 Holing**

26.4.3.1 Holes through more than one thickness of the material for members such as compound stanchion and girder flanges, where possible, be drilled after the members are assembled and tightly clamped or bolted together. The punching shall be permitted before assembly, provided the holes are punched 3 mm less in diameter than the required size and reamed after assembly to the full diameter. The thickness of the material punched shall not be greater than 16 mm.

26.4.3.2 When the holes are drilled in one operation through two or more separable parts, these parts when so specified by the purchaser shall be separated after drilling & burrs removed. (Is : 800-1991)

26.4.3.3 Matching holes for rivets and black bolts shall register with each other so that a gauge of 1.5 mm or 2 mm (as the case may be, depending on whether the diameter of rivets or bolts is less than or more than 25 mm) less in diameter than the diameter of the hole will pass freely through the assembled members in the direction at right angle to such members. Finished holes shall not be more than 1.5 mm or 2 mm (as the case may be) in diameter longer than the diameter of the rivet or black bolt passing through them, unless otherwise specified by the purchaser.

26.4.3.4 Holes for turned and fitted bolts shall be drilled to a diameter equal to a nominal diameter of the shank or barrel subject to HB tolerance specified in IS : 919-1990 Recommendations for engineering preferably, parts to be connected with close tolerance, shall be firmly held together by tacking bolts or clamps and the holes drilled through all the thickness at one operation & subsequently reamed to size. All holes not drilled at one operation shall be drilled to a smaller diameter and

reamed out after assembly. Where this is not practicable, the parts shall be drilled and reamed separately through hard bushed steel jigs.

#### **26.4.4 Riveting**

26.4.4.1 The rivets shall be heated uniformly throughout their length, without burning or excessive scaling, and shall be of sufficient length to provide a head of standard dimension. They shall, when driven, fill the holes completely and if countersunk, the countersinking shall be fully filled by the rivet, any protrusion of the countersunk head be dressed off flush, if required.

26.4.4.2 Riveted members shall have all joints firmly drawn and held together before and during riveting and special care shall be taken in this respect for all single or multiple riveted connections.

26.4.4.3 All loose, burned, or otherwise defective rivets shall be cut out and replaced before the structure is loaded and special care shall be taken to inspect single riveted connection.

26.4.4.4 Wherever practicable, machine riveting shall be carried out by using machines of the steady pressure type.

#### **26.4.5 Bolting**

26.4.5.1 Where necessary, washers used shall be tapered or otherwise suitably shaped to give the heads and nuts of bolts a satisfactory bearing.

26.4.5.2 The threaded portion of each bolt shall project through the nut at least one thread.

26.4.5.3 In all cases where full bearing area of the bolt is to be developed, the bolt shall be provided with a washer of sufficient thickness under the nut to avoid many threaded portions of the bolt being within the thickness of parts bolted together.

#### **26.4.6 Welding**

For welding of any particular type of joint, welders shall give evidence of having satisfactorily completed appropriate tests as described in the following relevant Indian Standards:

- (a) IS : 817-1991- Code of practice for training and metal arc welders.

- (b) IS : 7318-1974- A qualifying tests for metal are welders engaged in structural welding.
- (c) IS : 1393-1991- Code of practice for training and testing of oxygen - acetylene welders.

All welding shall be in accordance with any of the following standards, as appropriate.

- (a) IS : 816-1992 – Code of practice for use of metal are welding for general instruction in mild steel.
- (b) IS : 819-1992 – Code of practice for resistance spot welding for tight assemblies in mild steel.
- (c) IS : 822-1991 – Code of practice for inspection of welds.
- (d) IS : 823-1964 – Code of procedure for metal are welding of mild steel .
- (e) IS : 1024-1992 – Code of practice for use of welding in bridges and structures subject to dynamic loading.
- (f) IS : 1023-1987 – Code of practice for Oxygen- Acetylene welding for structural work in mild steel.

#### **26.4.7 Casting and Forgings**

26.4.7.1 The castings and the forgings are the bought out items used in the gate installation and as such these are intended to be strictly as per the specified drawings. All such work shall be laid out to secure good matching between adjoining unfinished surfaces. Castings shall be cleaned and shall be chipped and ground free from projections. Defects in castings involving repair by welding, shall preferably be disallowed in case of large discrepancies. Castings with minor defects may be repaired by welding. But shall necessarily be stress- relieved according to the requirement.

26.4.7.2 The castings or forgings of ferrous or non-ferrous nature shall conform to the following Indian Standards as appropriate :

- (a) The Stainless Steel (Corrosion resistant Steel) used for pins embedded parts shall confirm to ;

IS : 1570 – 1991

IS : 6911 – 1992

- (b) IS : 210-1991- Gray Iron castings (III revision)
- (c) IS : 306-1988 – Tin Bronze ingots and castings.
- (d) IS : 1030-1989- Carbon steel castings for general Engineering purposes.
- (e) IS : 1570-1991- Schedule for wrought steels for general Engineering purposes.
- (f) IS : 2004- 1991- Carbon steel forgings for general Engineering purposes.
- (g) IS : 2062-1992 – Structural steel (fusion welding quality)
- (h) IS : 2595-1991- Code of practice for radiographic testing.
- (i) IS : 2825-1984 – Code of procedure for stress relieving of welded joints.

#### **26.4.8 Tolerances**

Fits and tolerances of various components and parts shall be according to the best shop practice keeping in view the functional requirement of the parts. Tolerances and allowances of the matching parts during manufacturing and erection have been recommended in relevant paras and also at appendix D and E.

#### **26.4.9 Painting**

The code of practice laid down hereinafter, is to be adopted for protection of iron and steel structures against atmospheric corrosion under all climatic conditions.

##### **26.4.9.1 Surface preparation**

26.4.9.1.1 The surface shall be thoroughly cleaned and roughened by compressed air blasting or centrifugal blasting with a suitable abrasive grit. Immediately before spraying the surface shall be free from grease, scale, rust, moisture or other foreign matter.

26.4.9.1.2 The roughness of blasted surface shall be specified by the department or a criterion of acceptability shall be laid down by the department on the basis of the adhesion test, the method of which is laid down in para 5.3.1 of IS : 5805-1991.

##### **26.4.9.2 Spraying**

26.4.9.2.1 The metal spraying shall be carried out without delay after the surface has been prepared by suitable grit blasting, but in any case within such period that the metal is sprayed on to a surface within is still completely clean, dry and without visible oxidation.

If deterioration in the surface to be coated is observed, the surface preparation treatment shall be repeated on the surface in question.



26.4.9.2.2 The coating metal and its purity requirement shall be specified by the department as conforming to the IS : 2590-1992 and IS : 209-1992.

26.4.9.2.3 The surface to be sprayed shall be coated of uniform texture and free from lumps, coarse areas and loosely adherent powder. The nominal thickness of the coating shall be specified by the purchaser with the limits of 100 to 300 mm. The minimum local thickness, determined by the magnetic method described in IS : 3203-1992, shall not be less than 75% of the specified nominal thickness.

26.4.9.2.4 Sealing and finishing coats wherever applied on zinc and aluminium to provide additional protection shall be applied without undue delay. Contamination of the sprayed surface with oil, grease, dirt, finger marks etc. shall be avoided.

26.4.9.3 The schedule of painting during different stages of manufacturers, assembly, erection shall be specified by the department. The type of painting, number of coats, coverage rate, surface to be painted shall also be specified by the department. The methods of painting viz. hand brushing, metal spray painting and metal paint qualifications shall be specified by the department in the tender specifications.

## **26.5 Fixed Wheel And Slide Gates – Manufactures**

### **26.5.1 General**

For proper functioning of gates, the manufacturer shall lay down a quality control programme for each and every stage of manufacture. Certain criteria have been laid down which will facilitate proper installation and assembly, better maintenance and efficient working of the gates.

### **26.5.2 Materials**

**26.5.2.1** All materials and components required for the fabrication/manufacture of gate structures shall conform to the requirement of latest relevant Indian Standards. In absence of Indian Standard for any material or component, specifications must be laid down by department who may also specify the specifications for bought out items like bearings, castings, forgings, seals etc. However original manufacturers' test certificates for bought out item shall be referred.

**26.5.2.2** All castings or forgings shall conform to the relevant Indian Standards.

**26.5.2.3** Visual examination shall be carried out to find out the general soundness of castings and may if required be subjected to non-destructive tests.

**26.5.2.4** All forgings shall be suitably heat treated (if required) and shall be smooth and free from tool marks.

### **26.5.3 Welding**

**26.5.3.1** All welding shall conform to the relevant Indian Standards. Qualified welders according to IS : 7318-1974 shall be employed for welding work. Welding procedure for all major welds shall be drawn up and carried out. Test pieces may be made to ensure the soundness of the welding, if necessary.

**26.5.3.2** Visual examination shall be carried out of all welded joints to ensure that welding is free from.

- (a) Cracks on the surface of joints or parent metals located in the heated zones of the joint.
- (b) Undercuts in the parent metals.
- (c) Sponginess and porosity in the welding metal
- (d) Non-uniform width of fillet joints.
- (e) Mis-alignment and distortion of welded member and
- (f) Irregular reinforcing beads of weld.

**26.5.3.3** All major stress carrying parts of all welds shall be examined by non-destructive tests namely X-ray, ultrasonic etc. The stress relieving of part, if deemed necessary, shall be done as per procedure laid down in IS : 2825-1984.

### **26.5.4 Manufacturing tolerances.**

The embedded parts and the gates shall be manufactured to such accuracy as are required for the safe and efficient operation of the gates. As a general guide following tolerances may be used.

#### **26.5.4.1 Embedded parts**

- (a) Deviation of any point on the face of seal seats or track from a 2.0 mm machined straight edge held against it shall not exceed 0.5 mm.

- (b) Variation in distance between the face of the seal seat and the face of its respective wheel track shall not exceed 1.0 mm.
- (c) Deviation from straightness of the guide track shall not be more than 2.0 mm in 2 metre length.
- (d) There shall be no off- sets or gaps at any adjoining field joints between seal seats, wheel track and guide tracks.

**26.5.4.2 Fixed Wheel Gates**

- (a) These gates shall be so assembled that when a machined straight edge is held against all the wheels on either side in zero position it will not be possible to insert a feeder gauge thicker than 1.5 mm between any of the wheel and straight edge.
- (b) The distance between the side guide block or guide roller on one side of the gate to the corresponding guide block or guide roller on the other side shall not vary from the dimension shown on the drawing by more than 1.5 mm.

**26.5.4.3 Slide gates** – The gate and the components shall be so manufactured that on assembly the top side and top seal bases are in common plane within the tolerances as given below :

- (a) When a straight edge is held against seal bases, it shall not be possible to insert a 0.2 mm feeder gauge between the seal base and the straight edge.
- (b) When a machined straight edge is held against the metallic seal faces (after fixing metallic seals) it shall not be possible to insert 0.2 mm feeder gauge between seal face and the straight edge at any point.
- (c) The distance between the side guide blocks or the guide rollers on either side of the gate shall not exceed the dimensions shown on the drawing by more than 1.5 mm.

**26.5.5 Shop Assembly & testing for Gates and Embedded parts.**

**26.5.5.1** The manufacturing tolerance shall include surface finish tolerances (when specified) as specified under IS : 696-1960

~ >			-80 microns
$\overline{V}$			-40 -80
$\overline{V}$	$\overline{V}$		-16- 40
$\overline{V}$	$\overline{V}$	$\overline{V}$	Upto 16 microns

(one micron = 0.001mm)

**26.5.5.2** Shop assembly of embedded parts shall necessarily be done for high head gates. For medium and low head gates, it shall be done, if required.

**26.5.5.3** Gate shall be assembled complete with seals, wheels and guides either in horizontal or vertical position for proper alignment and inspection.

**26.5.5.4** Side guide blocks and rollers may be shimmed, if necessary, to maintain required tolerances.

**26.5.5.5** Variation in the distance between axes of each pan of seal seats, wheel tracks or side guide tracks for any gate shall not exceed 1.5 mm.

**26.5.5.6** Embedded parts shall be so assembled that the deviation of their axes from the respective alignment shall not exceed 1.5 mm.

**26.5.5.7** All the wheels of the gate shall be rotated several times to ensure free movement.

**26.5.5.8** The marking and match marking shall be made before actual dispatch of the components.

**26.5.6 Painting**

- 1) All the metal surfaces of the gate after thorough cleaning shall be given one coat of primary paint immediately. Each coat shall be allowed to dry or hardened thoroughly before the succeeding coat is applied.

## 26-21

- 2) Bronze, finished ferrous surfaces and hoist rope shall not be painted.
- 3) The unfinished interior surfaces of oil tank, and the unfinished surfaces of gears that will run in oil, shall be given 8 coats of oil resistant paint.
- 4) All finished surfaces of ferrous metal, including screw, threads, that will be exposed during transport shipment or while awaiting installation shall be cleaned as specified and given a heavy uniform coating of gasoline soluble rust preventive compound.
- 5) Field painting should be carried out at each stage step by step as it will be convenient with proper appropriate paints and the final painting shall be done after the complete assembly of gates.

### **26.6 FIXED WHEEL AND SLIDE GATES- ROPE DRUM HOIST**

#### **26.6.1 General**

These specifications shall be applicable for rope drum hoists for all types of gates viz. Radial, fixed Wheel or slide gates etc.

#### **26.6.2 Material**

**26.6.2.1** All materials and components used in the manufacture or assembly of the hoist shall conform to the latest Indian Standards. The duty of the hoist shall be specified by the purchaser. The purchaser has to specify the quality and standard of such material and components.

**26.6.2.2** All materials used shall be of tested quality. Original manufacturers test certificates for bought out items like the castings, forgings, worm reducers, wire ropes, motor and brakes etc. shall be furnished by the manufacturer of the hoist on demand.

**26.6.2.3** All castings and forgings used shall conform to relevant Indian Standards. Any repair to castings, if necessary, shall be carried out in accordance with the relevant Indian Standards. Forgings shall be free from any defect, tool mark and shall have smooth surfaces. Forgings used shall be heat treated where deemed necessary.

**26.6.3 Hoist Unit of gates and Checking.**

Following components of the hoist unit shall be checked.

- (a) Drive unit consisting of gear box, motor, brake, all mounted on a base frame.
- (b) Hoist drum and gear reduction unit mounted on a base frame and connected to drive unit by line shafts, limit switches and dial indicators.
- (c) Hoist rope, rope fixtures with accessories.
- (d) Arrangement for manual operation of gate.
- (e) Control panel.
- (f) Any other components.

**26.6.3.1** Drive unit gear box – It shall be checked for proper seating arrangement of the shafts and oil in gear box.

**26.6.3.2** Hoist motor – It shall be of approved manufacture capacity insulation and speed (R.P.M.) It shall conform to IS : 325-1991 unless otherwise specified and shall be checked for its performance. Manufacturer's test certificate shall be furnished for motor by supplier to purchaser.

**26.6.3.3** Brake – It shall be of approved manufacture capacity. It shall be checked for alignment and tightness. Brake liners shall be of approved manufacture and shall conform to the approved specifications.

**26.6.3.4** Base frame – the base frame for mounting of drive unit/ gear reduction unit with hoist drum shall be checked for the dimensional accuracy.

**26.6.3.5** Hoist Drum – This shall be checked for dimensional accuracy. Cast iron/cast steel drums shall be checked for blow holes, cracks etc. specially at groove centers. Fabricated drums shall be checked for stress relieving in approved manner. Rope grooves shall be checked for orientation. Arrangement of rope attachment to the drum shall be checked for security.

**26.6.3.6** Reduction unit gear box – It shall be checked for proper assembly, dimensional accuracy, sealing, finish of machined parts, and surface preparation for painting gears, pinions and other internal components shall be checked for alignment. Meshing of gear and pinion teeth shall be checked for alignment. It shall also be checked for contact surface and backlash by suitable methods such as applying a thin film of paint or grease on either pinion or gear wheel and running the assembly and noting the impression. Gears and pinions shall be checked for hardness. Tolerances of gears and pinions shall conform to IS : 919-1987 and backlash shall conform to IS : 4460-1991.

**26.6.3.7** Line Shaft – It shall be checked for straightness and other dimensions The straightness shall be in accordance with relevant

Indian Standards. Mounting of couplings shall be checked for alignment.

**26.6.3.8** Limit Switch – It shall be checked for satisfactory operation. It shall be weather proof.

**26.6.3.9** Dial Indicators – It shall be checked for satisfactory operation and accuracy.

**26.6.3.10** Hoist Rope – It shall be of approved manufacture and shall conform to relevant Indian Standards. The rope shall be checked for diameter, length, freedom and kinks, proper thimble end, connections and splicing. If the wire ropes are of galvanized type, the galvanization shall be in accordance with class II of IS : 1573-1991. Manufacturers test certificates shall be furnished on demand by supplier for hoist ropes.

**26.6.3.11** Rope Fixtures – It shall be checked for dimensional accuracy and their corrections.

**26.6.3.12** Arrangement for manual operation – It shall be checked for satisfactory operation. It shall be ensured that the gates are kept at required position during their travel for specified speed as envisaged in the design and specified for operational requirements of the gate.

**26.6.3.13** Control panel – Panels shall be checked for their suitability for the purpose envisaged in the specification. The checks shall include items such as weather proofing of conducting wires, proper construction of panels, high voltage tests, insulation resistance of cable, calibration of meters, earthing of installation, checking of connections and concealment if required.

#### **26.6.4 Lubrication of Gears and Bearings**

**26.6.4.1** For gears and pinions, lubricating oil/grease or lubricating compound used shall be of approved grade and quality.

**26.6.4.2** Bearings closed from outside and open from inside shall be checked for splash lubrication and bearing cover shall be free from leakage. For bearings closed from both sides, proper injection of grease of approved quality and grade shall be checked.

**26.6.5 Inspection of hoist assembly and checks.**

**26.6.5.1** The assembled hoist shall be checked for the following :-

- a) Quality of workmanship
- b) Overall dimensions.
- c) Optimum sound and vibrations
- d) Speed of operation allowing for variation in accordance with Indian Standards.
- e) Any mechanical jamming.

**26.6.5.2** Painting of different components of hoist shall be according to relevant Indian Standards.

**26.7 FIXED WHEEL & SLIDE GATE – ERECTION**

**26.7.1 General Inspection**

**26.7.1.1** It shall be ascertained that the gate parts received at the site of erection have been manufactured/fabricated according to the drawings and have necessary markings of shop inspection. It shall be ensured that all exposed surfaces of embedded parts are protected by painting, greasing etc. The surfaces of embedded parts in contact with concrete shall be free from greases, paint etc. for better bonding with concrete. A coating of cement wash/cement latex may be given, if necessary.

**26.7.1.2** Dimensional differences, if any, shall be accounted for before erection and the drawings corrected accordingly for erection. Critical dimensions shall be worked out from the drawings.

**26.7.1.3** The reference lines, center line of openings and levels relations to the completed civil structure shall be established on site so as to facilitate erection at proper locations.

**26.7.1.4** Shall be ensured that the various component of the hoisting arrangement such as motors, reduction gear assembly, switches, wire ropes and shafting are provided according to the specifications.



## **26.7.2 Inspection of block outs**

Concreting behind the gate groove may be done in one or two stages. If done in two stages, it shall be ensured that correct block outs are kept for accommodating the gate parts as manufactured according to the specifications/drawings. It is also to be ensured that the required dowel bars having adequate lengths are left out in the block outs. The entire block-out is roughened to ensure proper and necessary bondage to the second stage concreting.

## **26.7.3 Inspection of embedded parts**

**26.7.3.1** It shall be ensured that the sill beam is correctly positioned both in level and location. All the nuts and bolts of anchorages of sill beam shall be tightened so as to prevent dislocation during and after concreting.

**26.7.3.2** The embedded part that is track plates, guides, seal seats, gate groove lining etc. shall be checked when all parts are in final position at least upto double the gate height, in one operation. The check shall be carried out both in location and levels, with respect to sill beam already established in the position. Each part shall be checked first individually and thereafter relatively with the other parts. It shall be ensured that the manufacturing tolerances, as specified are considered while creating these parts and even after accounting these tolerances, the erection work is carried out according to the provisions in design and drawings.

**26.7.3.3** The track plates and seal seat shall be absolutely in true alignment. The alignment shall be checked by means of a plump bob and feeler gauge or micrometer, preferably at each 300 mm intervals from bottom to top side of the gate opening. Alternatively, diagonal checking or any other satisfactory method may be adopted for checking the alignments. (This check requires special attention).

**26.7.3.4** After having checked the track plates and seal seats on both sides, it shall be ensured that they are in their respective planes. It shall also be checked that top seal seat, wherever provided, shall also be in the required plane. (This check requires special attention).

**26.7.3.5** Guide and counter guides, if provided, shall be checked for true location and alignments.

**26.7.3.6** Groove liners and corner protection angles, when provided, shall be checked for true location and alignment.

**26.7.3.7** Following critical dimensions shall be checked at intervals of 300 mm from bottom to double the gate height. (See Fig. A & B)

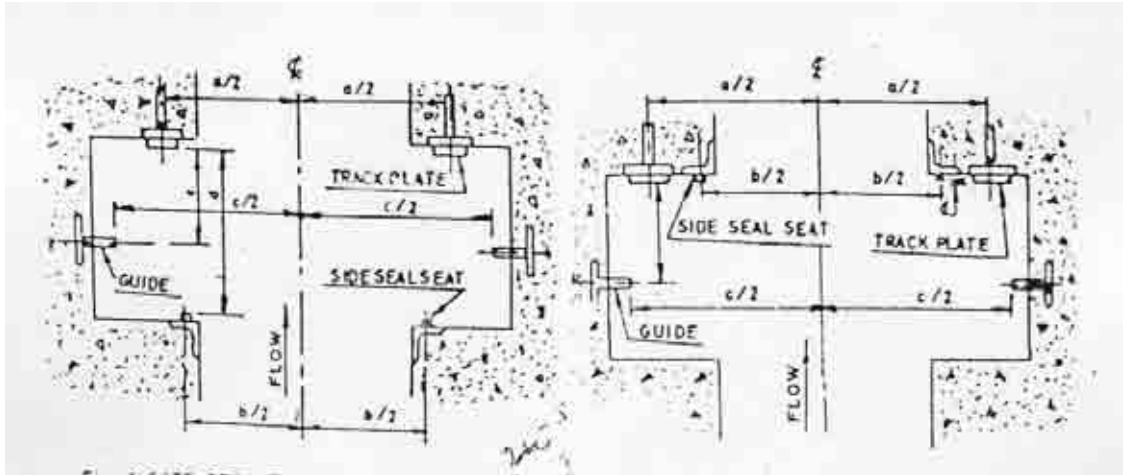

- a) Center to center distance of track plates.
- b) Center to center distance of side seal seats.
- c) Face to face distance of guides.
- d) Face of track plate to face of the side seal seat &
- e) Face of track plate to center line of guide.

Note – 1 Use of suitable template for checking (d) & (e) (See fig. A & B) is recommended to maintain corresponding portions of vertical embedded parts from sill level up to top of embedded parts.

Note – 2 Above double the gate height, the checking interval may be increased to one metre.

Note – 3 In case, top seal is provided the dimensions between the face of the track plate and face of top seal seat shall also be checked.

**26.7.3.8** Eccentricity or some such arrangement, if provided to a gate for its fine adjustment in the groove, shall not be accounted for while erecting embedded parts.

**26.7.3.9** Anchorages shall be fastened or welded rigidly, after final adjustment of embedded parts so as to prevent dislocation of parts while pouring second stage concrete.

**26.7.3.10** The gate groove concreting shall be done only after satisfying for all these details and keeping proper records there of. Rechecking of embedded parts shall be done after concreting.

**26.7.4 Inspection of the gate at site of erection**

**26.7.4.1** The gate which is received at site duly inspected in workshop shall be inspected at site before answering into the gate groove. Overall dimensions shall be checked to ensure that the gate fits correctly in the gate groove. It shall also be ensured before lowering, that the gate has been painted according to specifications.

**26.7.4.2** Following critical dimensions shall be checked at an interval of 300 mm wherever applicable.

- (a) Center to center distance between wheel treads.
- (b) Center to center distance between side seal/bases.
- (c) Face to face distance between guide shoes/rollers.
- (d) Face to seat base to wheel tread.
- (e) Center line of guide shoes/rollers to wheel tread in zero position.

**26.7.4.3** The seals & seal bases shall be checked to ensure that they are coplanar. All the wheels shall be adjusted to ensure that wheel treads are in their proper alignment. The wheel pins shall be locked after making the adjustment.

**26.7.4.4** The seal bolts shall be tightened adequately and uniformly.

**26.7.4.5** The gate wheels shall be checked for free rotation to ensure that they are not jammed during transport/handling. To check effectiveness of the seal, actual seal interference shall be compared with that provided in design, because on this aspect will depend to a great extent the efficiency of sealing arrangement and easy operation of gate.

**26.7.4.6** In case of counterweighted gate or gates with ballast, it shall be ensured that correct weight is added.

**26.8 FIXED WHEEL AND SLIDE GATES- INSPECTION OF COMPLETE GATE INSTALLATION**

**26.8.1** It shall be ensured that the installation of various parts of the hoisting arrangements have been done to specified location and alignment particularly in respect of correct positioning and attachment of rope/stem of the gate as well as hoist.

**26.8.2** There are several type of hoisting arrangement and the following considerations shall be looked into at the time of erection and subsequent inspection.

- a) Connections like shaft couplings, connections of wire ropes to the drum and to the gates connection of the stem rod to the gate and hoist, connection of stem links, connection of hoist components to the base etc. have been properly made.
- b) Intermediate supports for stem rods are provided the required levels and permit free movement of stem rod for the entire gate travel.
- c) In case of double stem hoists both the hoists shall be properly synchronized.
- d) The ends of wire ropes are properly looped and sufficient "U" clamps shall be provided.
- e) The rope is not loose and has been tightly wound over the rope drum. The rope shall be properly lubricated and shall have no kinks.
- f) The wire rope or chains at both ends of the gate and counter weight (if provided) shall have equal initial tension.
- g) Electrical installation shall be properly earthed.
- h) The limit switches shall be properly adjusted to the operational requirements.
- i) This may be checked by putting a spirit level on the horizontal top surface of gate or weight. The bubble of spirit level should be in the center with the weight gate is hung and not resting on the sill or platform.

**26.8.3** It shall be ensured that the gate groove, sill and the embedded parts are thoroughly cleaned and no foreign material is present in the groove. Before lowering the gate it shall be perfectly ensured that the gate groove is free from any obstruction.

**26.8.4** The hoist provided for the operation of the gate shall first be allowed to run under no load” (without connection to gate) to ensure its satisfactory working and that there is no undue temperature rise due to friction in the rotating/moving components.

## **26.9 FIXED WHEEL AND SLIDE GATES – TESTING**

**26.9.1** The gate shall be tested first in the dry condition with the hoist duly connected to the gates. The gate shall be moved up, and down in the groove to ensure its smooth working and that there is no obstruction and no undue effort required for its operation. In case the gate is not going down of its own weight or found tight in some position, reasons shall be investigated and remedied instead of forcing the gate down. While testing the gate in dry condition, the rubber seals should be kept wet by water jetting or other suitable methods to avoid damage and to wear to the seals.

**26.9.2** The testing of the gate seals in dry conditions shall be done by viewing the contact surface against a tight source. It shall be ensured that the top seal rides smoothly over the top seal seat at the time of its approach to the latter.

**26.9.3** In case of rubber seals, water should be poured over the seals so that there shall not be dry friction of the seals. In case of metal contact oil or grease is to be used no grease or lubrication to be used for rubber seals.

**26.9.4** There shall be no noise of friction any other noise no signs of excessive friction, no jerky performances , no dug in any position, no dangling of the gate, no twist in the rubber seals, top seal does not leave its plane and the rubber seals are not over pressed.

**26.9.5** The gate, after lowering, is to be kept resting on the sill beam, i.e. in close position. The leakage test may be taken in this position by using suitable pump with necessary arrangement of jetting water at 1.5 times the designed pressure on sealing positions from bottom to top. Particularly all corner joints and other joints, if any are in to be tested to ensure perfect working of the gate.

**26.9.6** The gate shall be fully opened or closed to ensure full opening and satisfactory closing. The time needed for 300 mm opening or closing of the gate is to be recorded for calibration purposes at the time of actual operation.

**26.9.7** In rope drum hoists, it is to be tested that the gate is going down of its own weight, or with Ballast provided, and no additional force is needed. The gate I also going down or coming up vertically and there is no uneven pull to the gate. Also winding of rope over the drums is uniform and is according to the design provision.

**26.9.8** The tests as provided from 26.8.1 to 26.8.7 shall also be performed against water load when conditions permit.

**26.9.9** The torque required for movement of the gate on load shall be measured and checked against designed value.

**26.9.10** Under the designed water head conditions the leakage through the gate should not exceed 15 litres/minute/meter length of the seal.

**26.9.11** When the gate is operated under water load, it is to be ensured that there is no vibration to the gate, hoist or civil structures at various gate openings.

**26.9.12** By pass arrangement made for water and air vent, when provided shall be checked for proper working of the system.

## **26.10 RADIAL GATES - MANUFACTURING**

### **26.10.1 General**

This part of chapter lays down the recommendations for inspection, assembly testing of radial gates at the manufacturing stage. The hoisting equipment viz. ropes drum hoists have been covered in the later part of this chapter.

#### **26.10.2 Material**

**26.10.2.1** All materials used shall conform to latest Indian Standards as detailed in Appendix-C.

**26.10.2.2** All materials used shall be of tested quality. Original manufacturer's test certificates for bought out items such as castings forgings and seals shall be asked for ensuring quality.

**26.10.2.3** All castings/forgings shall conform to the latest Indian Standards. Visual examination/inspection shall be done to ensure the soundness and surface smoothness. If required, non destructive tests shall be conducted.

#### **26.10.3 Welding**

**26.10.3.1** The selection of electrodes, welding procedure, investigation of defects and testing of welds shall be in accordance with procedure laid down in para 26.4.3.

**26.10.3.2** Any part of item may be stress relieved according to the requirement and procedure laid down in IS:2825-1984. Generally following items require stress-relieving.

a) Yoke/trunnion girders, anchor girder, and trunnion brackets, where heavy welding is involved.

b) Trunnion hub is part of the arm (structural portion) is welded to the casting.

#### **26.10.4 Manufacturing tolerances**

The gates and embedded parts shall be manufactured to such accuracy and tolerances as are required for the safe and efficient operation of gates. Following tolerances shall be maintained as a general guidance.

26.10.4.1 Embedded parts

26.10.4.1.1 Deviation of any point on the face of seal seat from 2.0 M machined straight edge held against it shall not exceed 0.5 mm.

26.10.4.1.2 Deviation from straightness of the wall plate shall not be more than 2.0 mm in 2.0 m length.

26.10.4.1.3 Offsets and gaps at any adjoining joints between seal seats, guides etc. shall not exceed 0.5 mm.

26.10.4.1.4 When Yoke girder and anchor girder are inter connected by the flats or tie rods the linear dimensions shall be within the limits specified under IS 2102-1991 (Allowable deviations for dimensions without Special tolerances).

26.10.4.2 Gates

26.10.4.2.1 The gates leaves with stiffners shall generally be manufactured on a jig and fixture. The tolerances on the radius of gate shall be 1/1000 of radius or + 10mm whichever is less.

26.10.4.2.2 The distance between the side guide roller/guide shoes on one side of the gate to the corresponding guide roller/guide shoes on the other side shall not vary from dimension shown in the drawings by more than + 0.00mm to 2.00mm.

26.10.4.2.3 Paralled distance of centre line of both the trunnion bearings from upstream bottom edge of skin plate shall not vary more than 13.0mm.

26.10.4.2.4 The horizontal distance between the centre to centre of trunnions shall not vary from the dimension shown in the drawings by more than 13.0 mm.

26.10.4.3 Connections - At all splices, the holes shall be match drilled. If fit bolts are provided, the holes shall be reamed at assembly.

26.10.5 Shop assembly and testing (Gate & Embedded Parts)

26.10.5.1 The anchor girder together with the tie bars of convenient length for testing and yoke girder shall be load tested equivalent to 1.5 times the design load before erection. The load shall be applied gradually by means of hydraulic jocks and the assembly shall remain under load to enable all the observations required by test procedure to be made.

26.10.5.2 Assembly of wall plates and sill beams shall be done at the shop.

26.10.5.3 Gates shall be assembled complete with guide rollers and trunnions for proper alignment and inspection. All the specified dimensions in para 26.9.4.1 and 26.9.4.2 and other central dimensions shall be checked on assembly.

26.10.5.4 Side guide rollers may be shimmed if necessary, to maintain the required tolerances as specified in para 26.9.4.2.2.

26.10.6 Seals

Seals may be assembled either at shop or during erection according to the convenience. The holes in seals shall be match drilled with seals base and clamps. The seals used shall conform to specifications at Appendix-F.

26.10.7 Match-marking

All erection marks shall be hand punched. All the components shall be match marked before dismantling.

26.10.8 Cleaning & Painting

Surface shall be cleaned thoroughly, preferably by sand/shot blasting. Painting shall be as specified and the procedure shall be recommend by the paint manufacturer and as per procedure described under para 26.4.6.

26.11 RADIAL GATES - ROPE DRUM HOIST

26.11.1 Service requirement

Rope Drum Hoists for crest radial gates shall be capable of lifting and closing the gates under full unbalance head for which the gates are designed.

While computing hoist capacity, 20% reserve hoist capacity may be taken in to consideration. The lifting speed for the hoist shall be 0.30 m per minute.

26.11.2 General arrangement

The rope drum hoists, shall be electrically operated. They shall be installed on the hoist bridges to be provided for them. The hoist shall be provided with local & remote control gate position indicators.

26.11.3 Operating characteristics

26.11.4.1 All hoists shall be operated either from hoist bridge located on top of the piers or from remote control cabin.

26.1.4.2 The control system shall fully open or close the gate at the minimum speed of 0.3 m/min,.

26.11.4.3 All electrical switches shall be push button type and shall be flush mounted. All internal wiring of the control of the power cabinet shall be furnished by the seller.

26.11.5 Design data - All important design data shall be specified which interalia may include the following information (a) Location of radial gates (b) number of hoists (c) MWL & FRL (d) Hoist capacity (e) Gate travel (Financial) Raising and lowering speed of the gate (g) Permissible stresses.

26.11.5.2 The allowable stresses for some of the materials are as stated as per para 5.0 of this volume. Where the allowable stresses have not been specified they shall be taken one half (1/2) of the yield stress or 1/5th of the ultimate tensile stress whichever is less.



26.11.5.3 In case any material conforming to different equivalent specifications is used, if permitted, the stresses allowed shall not exceed, the allowable stresses previously got approved from the buyers.

26.11.6.1 Wire ropes - The steel wire ropes shall be of 6 x 37 const. fibre core conforming to I.S. specifications for steel wire ropes for general engineering purposes (IS:7266-1991). The wire rope shall be provided with a device that would take care of unequal stretch of rope. The minimum factor of safety of the wire rope shall be under normal operating condition and 3 under break down torque condition.

26.11.6.2 Rope drum - The drum shall be made from cast steel (27-54 grade) conforming to Indian Standards on topic "Specifications for steel castings for general engineering purposes" IS:1030-1989).

26.11.6.3 Gears - All spur gear wheels shall be cast steel (27-54) grade conforming to IS:1030-1989 and pinion shall be forged steel (class 3A) conforming to IS::2004-1991.

26.11.6.4 Shafts - All shafts shall be made of carbon steel conforming to Indian Standard schedules for wrought steel Part V stainless and heat resisting steels (I revision) (with amendment No.1) IS: 1570 (Pt. V) 1991.

26.11.6.5 Bush Bearings - Drum shafts shall be provided with bush bearings of aluminium bronze confirming to IS Specifications for aluminium bronze ingots and castings (second revision) IS:305-1991.

26.11.6.6 Couplings - All couplings shall be cast steel (27-54 grade) conforming to IS:1030-1989 and forged steel (class 3A) conforming to IS:2004-1991.

26.11.6.7 Gear Boxes - Gear boxes shall be of rigid construction filled with inspection covers and lifting handles. The gear boxes shall be so designed that the gears can easily be removed or replaced and shall be such that the gears are suitable lubricated. Facilities for oil filling and draining connection for oil level indicating and adequate breathing shall be provided. The gear box shall be made of structural steel conforming to IS:726-1990/IS:2062-1992.

26.11.6.8 Gate position indicators - Local indication of the gate position shall be provided on the rope drum hoist. Remote indication shall also be provided at remote control cabin.

26.11.6.9 Access ladder & platform - A permanent access ladder for providing access to the top of each rope drum hoist alongwith support platform of not less than 8 mm chequered plates & guard railing shall be provided on the hoisting bridge. These shall permit approach to the top at each rope drum hoist for inspection, maintenance and operation of the hoist. Hoisting bridge for hoist assembly etc. shall be provided by the seller.

26.11.6.10 **Hoist Assembly & Test** - Fabrication of the parts shall be carried out under strict supervision of trained technical personal. If the buyer desires to inspect the work during the course of fabrication the same shall be done during working hours at the workshop. The work done in the workshop shall be subjected to inspection from time to time from the buyer. The seller shall provide all facilities required for such inspection of material, fabrication of component testing of materials parts at the place of manufacture and erection. The seller shall before

shipment make such assembling and tests of the various parts of the hoists and hoisting accessories and of the controls as may be required in his workshop to ensure that all parts fit and operate properly and that all dimensions and all tolerances requirement are in accordance with the specifications and drawings. The seller shall demonstrate and operate the equipment for the inspection of the buyer before disassembly and preparation for shipment.

#### 26.11.7 **Electric equipment**

26.11.7.1 **General requirement** - All electric equipments covered under these specifications shall conform to Indian Standard specifications and of high quality and suitable for application for duty and function which the particular accessories shall be required to perform in the operation of the crest radial gates. The type manufacturer's name, type performance and readings of all such items shall be given for each of the electrical equipments. The power supply shall be 400/440 volts, 3 phase 50c/s, AC and 230/240 volts single phase 50c/s. AC.

26.11.7.2 **Schedule of requirement** - Control cabinet in the control chamber for each crest radial gate hoist shall be acquired with the following equipments located suitably in the cabinet.

- 1) Electric motor
- 2) Convenient size heaters for motor with operating switch
- 3) Convenient size heaters with operating switch for control cabinet.
- 4) Motor starters
- 5) Circuit breaker backed by short circuit fuses for motor
- 6) Current transformer
- 7) Local control selector switches (double pole, two positions stay put mechanical locking type)
- 8) Control switches - Raise / lower
- 9) Push button "Stop"
- 10) Electric motor starter relay
- 11) Resistors for various lamp indication circuit
- 12) Red lamps for closed position of crest radial gate
- 13) Green lamps for open position of crest radial gate
- 14) Amber lamp for crest radial gate in movement
- 15) Control circuit supply heating lamp indication
- 16) Control circuit supply tripped lamp indication
- 17) Blue lamp for crest radial gate partly opened / closed position.
- 18) Electronic type transmitters along with electronic type digital receiver for indication of gate travel position in the remote control cabinet located in non overflow block.
- 19) Any equipment not mentioned in the list but the buyer/seller feels essential.

26.11.7.3 **Control Cabinets** - Every rope drop hoist shall have separate control cabinet. The control cabinet in the control chamber shall be of sufficient size so as to neatly & methodically accommodate all the required electrical equipment and appurtances. Each cabinet shall have two compartments. The lower compartment shall accommodate circuit breakers for power supply to motor & control circuit, starters, heater switches, control switches, stop push buttons and indicating lamps. Each compartment shall be provided with independent lockable doors. All equipments shall be flush mounted. The location of mounting brackets and tapped holes and layout of the equipments in the control cabinets shall suit in particular commercial equipment furnished, all necessary bolts, screws & other fastners for mounting commercial equipment, shall also be furnished by the seller.

The control cabinet shall be completely assembled wired & tested in shop. The suitable insulation wiring shall be adequately designed, neatly installed and fastened. Electrical connection shall be made only at apparatus terminal blocks. The splices or laps shall be permitted between terminal connections. Terminal field connections shall be accessible without disturbance to internal wiring. To prevent condensation of moisture, each cabinet shall be provided with single phase 230/250 volts cartridge heater. All wiring shall be furnished by the seller. Each control cabinet shall be of not less than 3 mm. thick steel sheet, suitably reinforced where required. The assembled cabinet shall have neat appearance and all exterior sharp corners, welds & surface irregularities shall be ground smooth. The doors shall swing freely on hinges and shall close without sticking. All the locks of the cabinets shall be keyed alike with keys removable in either locked or unlocked position. Four sets of keys shall be supplied for each cabinet.

**26.11.7.4 Electric motor** - One electric motor, shall be provided for each type drum hoist. The electric motor shall be 400/440 volts, 3 phase, 50 c/s equipped cage, non reversing type with high starting torque characteristics and shall conform to Indian Standard specifications for three phase induction motor (Fourth Revision) IS : 325-1991 as regards rating, characteristics & tests unless otherwise specified herein. The motor shall be totally enclosed, Fan cooled & suitable for use in tropical climate and highly humid atmosphere.

The electric motor shall be of sufficient capacity to carry continuously the maximum possible load likely to develop under all stipulated conditions without exceeding the name plate ratings.

The insulating materials, for electric motor shall conform to the I.S. Classifications of insulating materials for electric machinery & apparatus in relation to their thermal stability in service IS:1271-1990.

The maximum temperature of the wiring, when the electric motor is delivering the rated output continuously at the rated voltage and frequency shall not exceed 70C above the ambient temperature of 28°C. The temperature rise of others parts of the motor shall be in accordance with the IS:325-1991.

The electric motor shall be furnished duly coated by the protective material approved by the Buyer to prevent formation of rust & corrosion due to affects of moisture. All electric motors shall be of the same make & latest model.

All electric motor bearings shall be self lubricating type which shall be properly sealed against loss of lubricant or entrance of dust.

To prevent condensation, the electric motor shall be equipped with 230/250 volts, single phase heaters nominated in or on the phase. The loads of the electric motor and the ant condensation heater shall be brought out in a terminal box on the motor having suitable cable entry lugs.

**26.11.7.5 Wiring** - All wirings of power control cabinets shall be neatly installed, connected and securely anchored in poles in a workman like manner. Electric connections shall be neat, mechanically tight and secure and shall be made of apparatus terminals & terminal blocks. Terminals for field connections shall be accessible freely. The insulation of control wiring shall be of polyvinyl chloride or similar synthetic insulation of 650 volts grade. All conductors connected to restore or otherwise subject to abnormal heat shall be 650 volts grade heat resistant installation. All wiring shall be weather proof and suitable for tropical

climate and highly humid atmosphere. Wherever necessary the wiring shall be carried in metal conduits. All electrical conduits shall be heavy gauge and shall be hot dip galvanized and shall conform to Indian Standard Rigid steel conduits (With Amendment No.1) IS:9537 (Part II) 1990 and Indian Standard "Rigid plain conduits of insulating materials" IS:9537 (Part III) 1990.

**26.11.7.6 Flexible coupling** - The flexible coupling, between the motor and worm gear reducer shall be an all metal type suitable for accommodating radial and angular misalignment, the coupling shall be of adequate capacity to drive the worm gear reducer and shall be accurately bored and key seated to lift the motor and line shaft.

**26.11.7.7 Circuit breaker** - One air insulated triple pole circuit breaker, shall be provided for the control of each motor. It shall be suitable for use as back up protection against short circuit current and in accordance with Indian Standard specification for alternating current circuit breakers requirements and tests, Section 1 voltages not exceeding 100 VAC or 1200 VDC (first revision) I.S. 2516(Part I & II/ Section 1)-1991. The circuit breaker shall be provided with thermal air load release. The intersecting capacity of the circuit breaker shall not be less than 5000 amps. Provision shall exist on the circuit breaker for the adjustment of trip setting to suit the requirements of Electrical motor.

**26.11.7.8 Motor Starter** - For each motor one magnetic motor starter of suitable capacity rated for 400/440 Volts, three phases 50 C/S AC & direct on the line starting service shall be provided.

The starter shall be suitable for working in conjunction with the control relay for thermal overload single phasing protection and shall have no volt release coils. Preferably the starter shall be of same make & model as the Electrical motor.

**26.11.7.9 Control switch** - For raising the gate spring loaded control switch of self resetting type shall be provided. The switch shall be provided momentary contact when its handle is operated to position ® for raising the gate. The control switch shall be of heavy duty type having silver plated contacts and suitable for flush mounting on a panel. The rating shall be 5 amps, 230/250 Volts, 50 C/S A.C.

**26.11.7.10 Push button** - For stopping the gate at an intermediate position, spring loaded push button shall be provided. The push button shall be heavy duty type having silver plated contracts and suitable for flush mounting on the panel. The push button shall have normally closed contacts. The rating shall be 5 amps, 230/250 Volts, 50 C/S A.C.

**26.11.7.11 Indicating lamps** - To indicate the gate at extreme positions and other positions, indicating lamps shall be provided as under -

i)	Gate fully opened	Green indicating lamp
ii)	Gate fully closed	Red indicating lamp
iii)	Gate intermediate	Blue indicating lamp
iv)	Gate in moving position	Amber indicating lamp

The indicating lamps shall be watertight rated, for heavy duty type 230/250 volts AC and suitable for flush mounting on the control cabinets.

**26.11.7.12 Heater Switch** - Suitable single pole disconnecting heaterswitch shall be provided for the heater in each electric motor in the control cabinets. It shall be heavy duty type rated for 5 amps, 230/250 Volts AC supply.

**26.11.7.13 Control Relay** - For overload and single phasing protection of motor, 3 control relay shall be provided. The overload device shall be set or adjusted to trip the starter between 115% - 120% of the rated normal full load running current of the motor. The relay shall be capable of resetting manually.

**26.11.7.14 Gate Selector Switch** - Gate selector switches composed of three single pole, 3 position rotary type switches installed in tandem and operated by a common switch rated for 5 amps, 230/250 volts 500 hertz A.C. supply and suitable for flush mounting on panels shall be provided to select a gate for operation.

**26.11.7.15 Gate position contacts** - The site of electrical contacts which shall operate at position corresponding to the position of the gate shall be provided. These contacts shall be utilized in the control circuit for automatic starting or stopping of electric motor for obtaining light indication for various travels of the gate.

The contacts shall be heavy duty type rated for 5 amps, 230/250 volts 50 c/s A.C. supply, operation of the contacts shall be as follows -

Contact 1-2	Normally closed	Opens when gate started raising
Contact 3-4	Normally open	Closes when gate fully raised

**26.11.7.16 Limit Switch** - The limit switch shall be suitable for service under conditions of extreme moisture. It shall be drilled and tapped for conduits and shall be suitably designed to be wired and serviced after being mounted in position. It shall have single pole, double break contacts to operate at 230/250 volts single phase 50 c./s A.C. supply.

**26.11.7.17 Electronic type transmitter with electronic type Digital receiver** - Electronic type transmitter with electronic type digital receiver for indication in the remote control cabined shall consist of a transmitter and a receiver set and shall be used for remote indication of the gate position for each crest Radian gate. The transmitter shall be suitably mounted on the respective gate and the receiver shall be housed in the remote control cabinets. The transmitter and receiver sets shall be minutely synchronised to have absolute identical performance.

**26.11.7.18 Remote control** - The seller shall provide complete arrangement including control cabinets, switches and all electrical accessories including complete wiring for the entire arrangement. The seller shall submit detailed drawings showing layout of the complete arrangement, sizes of proposed panels and shall furnish operational circuit diagrams, details of electrical items and accessories used and illustrative pamphlet of proposed transmitting and receiving units. The seller shall also furnish details of erection including foundations of the control cabinets.

**26.11.7.19 Electromagnetic Brake** - The electro magnet brake shall be of spring set, shoe type. It shall be operated and continuously rated. The brake shall be capable of over coming atleast 140% of the full load torque exerted by the

motor. The brake shall set automatically when the current is cut off from the motor and it shall be electrically released when the current is applied to the motor. The brake shall be equipped with a hand operated release lever.

**26.11.7.20 Hand operation arrangements** - Provision shall also be made for operating the hoist manually in case of failure of power supply. electrical inter locks shall be provided to prevent operation by electrical power when the manual drive is engaged. Manual operation shall be as per Indian Standard IS:6938-1989.

**26.11.7.21 Lubrication** - The lubrication of the motor, gear reducers, roller and bush bearings shall be as specified by the manufacturer of the respective equipment. The points of lubrication of the bearings and journals shall be readily accessible. Grease grooves shall be provided in the bearing surfaces for satisfactory distribution of the lubricant. A level type hand compressor for forcing the lubricant to the bearings shall be provided by the seller. The hand compressor shall be equipped with heavy duty flexible metallic hose and coupling suitable for the industrial bottom type fittings.

## **FIXED WHEEL AND SLIDE GATES – ROPE DRUM HOIST**

### **26.12.1 General**

These specifications shall be applicable for rope drum hoist for all types of gates viz. Radial, Fixed Wheel or Slide gates etc.

### **26.12.2 Materials**

All materials and components used in the manufacture or assembly of the hoist shall conform to the latest Indian Standards. The duty of the hoist shall be specified by the purchaser. The purchaser has to specify the quality and standard of such material and components.

**26.12.2.1** All materials used shall be of tested quality. Original manufacturer's test certificates for bought out items like the castings, forgings, worm reducers, wire ropes, motor and brakes etc. shall be furnished by the manufacturer of the hoist on demand.

**26.12.2.2** All castings and forgings used shall conform to relevant Indian Standards. Any repair to castings, if necessary, shall be carried out in accordance with the Indian standards. Forgings shall be free from any defect, tool mark and shall have smooth surface. Forgings used be heat treated where deemed necessary.

### **26.12.3 Hoist Unit of Gate and Checking**

Following components of the hoist unit shall be checked.

- a) Drive unit consisting of gear box, motor, brake, all mounted on a base frame.

- b) Hoist drum and gear reduction unit mounted on a base frame and connected to drive unit by line shafts, limit switches and dial indicators.
- c) Hoist rope, rope fixtures with accessories.
- d) Arrangement for manual operation of gate.
- e) Control Panel
- f) Any other components.

**26.12.3.1 Drive unit gear box** – It shall be checked for proper seating arrangement of the shafts and oil in gear box.

**26.12.3.2 Hoist motor** – It shall be of approved manufacture, capacity, insulation and speed (R.P.M.). It shall conform to IS : 325-1991 unless otherwise specified and shall be checked for its performance. Manufacturer's test certificates shall be furnished for motor by supplier to purchaser.

**26.12.3.3 Brake-** It shall be of approved manufactures and capacity. It shall be checked for alignment and tightness. Brake liners shall be of approved manufacture and shall conform to the approved specifications.

**26.12.3.4 Base Frame** – The base frame for mounting of drive unit/gear reduction unit with hoist drum shall be checked for the dimensional accuracy.

**26.12.3.5 Hoist drum** – This shall be checked for dimensional accuracy. Cast iron/cast steel drums shall be checked for blow holes, racks etc. specially at groove centers. Fabricated drums shall be checked for stress relieving in approved manner. Rope grooves shall be checked for orientation. Arrangement of rope attachment to the drum shall be checked for security.

**26.12.3.6 Reduction unit gear box** – It shall be checked for proper assembly, dimensional accuracy, sealing, finish of machined parts, and surface preparation for painting gears, pinion and other internal components shall be checked for alignment. Meshing of gear and pinion teeth shall be checked for alignment. It shall also be checked for contact surface and backlash by suitable methods such as applying thin film of paint or grease on either pinion or gear wheel and running the assembly and noting the impression. Gears and pinions shall be checked for hardness. Tolerance of gears and pinions shall conform to IS : 919-1987 and backlash shall conform to IS : 4460-1991.

**26.12.3.7 Line Shaft** – It shall be checked for straightness and other dimensions. The straightness shall be in accordance with relevant Indian Standards. Mounting of couplings shall be checked for alignment.

**26.12.3.8 Limit Switch** – It shall be checked for satisfactory operation. It shall be weatherproof.

**26.12.3.9 Limit Indicators** – It shall be checked for satisfactory operation and accuracy.

**26.12.3.10 Hoist rope** – It shall be of approved manufacturer and shall conform to relevant Indian Standards. The rope shall be checked for diameter, length, free from bends and kinks, proper thimble end, connections and splicing. If the wire ropes are of galvanized type, the galvanization shall be in accordance with class II of IS : 1573-1991 Manufacturer's test certificate shall be furnished on demand by supplier for hoist ropes.



**26.12.3.11 Rope fixtures** – It shall be checked for dimensional accuracy and their corrections.

**26.12.3.12 Arrangement for manual operation** – It shall be checked for satisfactory operation. It shall be ensured that the gates are kept at required positions during their travel for specified speed as envisaged in the design and specified for operational requirements of the gates.

**26.12.3.13 Control Panel** – Panels shall be checked for their suitability for the purpose envisaged in the specification. The checks shall include items such as weather proofing of conducting wires, proper construction of panels, high voltage tests, insulation resistance of cable, calibration of meters, earthing of installation, checking of connection and concealment if required.

**26.12.4 Lubrication of gears and bearings.**

**26.12.4.1** For gears and pinions, lubricating oil/grease or lubricating compound use shall be of approved grade and quality.

**26.12.4.2** Bearings closed from outside and open from inside shall be checked for splash lubrication and bearings covers shall be free from leakage. For bearings close from both sides, proper injection of grease of approved quality and grade shall be checked.

**26.12.5 Inspection of hoist assembly and checks**

**26.12.5.1** The assembled hoist shall be checked for the following :

- a) Quality of workmanship
- b) Overall dimensions
- c) Optimum sound and vibrations
- d) Speed of operation allowing for variation in accordance with Indian Standard.
- e) Any mechanical jamming.

**26.12.5.2** Painting of different components of hoist shall be according to relevant Indian Standards.

**26.12.6 General inspection**

**26.12.6.1** It shall be ascertained that the gate parts received at erection site have been manufactured according to the drawings and have necessary marking of shop inspection as prescribed. It shall be ensured that all exposed surfaces of the embedded parts have been protected by painting, greasing etc. as specified. The embedded parts in contact with concrete shall be free from grease, paint etc. For better bonding with concrete a coating of cement wash/cement latex may be applied, if prescribed.

**26.12.6.2** The reference/center lines of piers and bays and the levels having relations to complete, civil structure shall be established at site so as to facilitate erection at proper indications.

**26.12.6.3** It shall be ensured that the various components of the hoisting arrangement, such as meters, reduction gear assembly, switches, wire ropes etc. are provided according to the manufacturer's instructions and erected according to the hoist supplier's drawings remitted by the purchaser.

**26.12.6.4** The permissible tolerances for the embedded parts and the components of gate shall be in accordance with the appendix D of IS : 4623-1990

**26.12.6.5** Inspection of blockouts – It shall be ensured that correct blockouts are kept for accommodating the embedded parts as manufactured according to the design and drawing approved by the purchaser.

**26.12.6.6 Block Out** – The block out should have sufficient gap left out in the concrete, so that a band with spanners etc. should be able to work freely inside the block out. The minimum block out gap for first stage concrete in the sill beam portion should be 800x600 mm and for second stage concrete it should be 600x400 mm. Similarly for wall plate the gap should be 750x650 mm and for second stage concrete it should be 750x250 mm. It shall also be ensured that the required dowel bars having adequate lengths are left out in the blockouts during first stage concrete. The entire block out is roughened properly for further concreting to give necessary bondage to second stage concreting.

**26.12.7 Inspection of pier anchorage**

**26.12.7.1** The inspection of pier anchorage shall be carried out at following stages :

- a) Trunnion bracket and support girder.
- b) Load carrying anchors or ties and embedded girder (if insulated anchors or ties are used.)
- c) Anchor girder or yoke girder.
- d) Thrust block/trunnion tie.

**26.12.7.2** The pier anchorages shall be checked with respect to the center line of the pier and the trunnion axis (line parallel to the crest axis and passing through the center line of trunnion pins) Control survey marks shall be given on each pier to check the location/alignment of pier anchorages. These shall include the lines parallel to the end at right angles to the dam/barrage axis and a bench mark for level.

**26.12.7.3** Center to center distance of the adjacent piers shall be checked by a steel tape. It will be preferable to put a steel girder across the span for taping the distance over the spa.

**26.12.7.4** The trunnion bracket/ supports shall be placed on the top of a steel and kept in position with the help of struts and their position shall be checked with respect to center line of pier and trunnion axis. A dummy trunnion assembly may be used to check the distance between center line of trunnion and sill beam center. The slope of trunnion assembly shall be checked with help of an inclination gauge. The two trunnion assemblies for each gate shall be checked with respect to each other.

**26.12.7.5** The yoke girder/anchor girder shall be checked for its alignment and slope in both directions. For this checking holes may be picked up from dummy trunnion bearing.

**26.12.7.6** Before erection the tie bars/ rods shall be checked on a level platform for straightness and defect, if any, shall be rectified forthwith. After erection the slope and spacing of the tie bars/; rods shall be checked. For checking the spacing, a spacer gauge shall be used. After assembly the entire pier anchorages shall be checked. The two anchorages for each gate shall be checked with respect to each other.

The length of the anchor flat or bolt should be  $0.6 R$  where  $R$  is the radius of the curvature of the radial gate.

The measurement of  $0.6 R$  may be measured to the face of the anchor. Girder to the face of the pier i.e. the total embedded portion should be  $0.6 R$ .

The inclination of anchor flat or tie bar or the flat should be checked with the inclination of the arm of the gate, that they should not interfere at the time of opening of the gate.

**26.12.7.7** Before concreting the pier after erection of pier anchorages, it is necessary that a second check of all the parts is made to ensure against any possible displacement during welding, riveting etc. For safety or erected anchorages, the grouting/concreting operations shall be commenced after minimum possible intervals. For insulated anchors/ties. The insulation shall be provided and checked before starting the grouting/concreting operations. To allow for the elongation of the insulated load carrying anchors and trunnion tie if used to trunnion bracket shall be so fixed so as to be able to slide on the anchorage girder. Bronze pads shall be used for this purpose on the top of the anchorage girder and at the bottom of the trunnion bracket as shown in fig. 3 C.

**26.12.7.8** Anchor bolts shall be provided in the first stage concrete with suitable blockout openings, to hold the track base and seal seat assemblies. The anchor bolts shall be with double nuts and washers. For adjustment purposes enclosed holes in the seal base parts shall be provided so as to allow for misalignment of anchor bolts. The minimum size of holes shall not be less than that given in table 1. The first stage and second stage concrete should be one grade above than the concrete of surroundings crest or piers.

Table 1 – Holes and Washers for anchor bolts

Bolt dia (mm)	Hole in member Dia (mm)	Hole in washer Dia (mm)	Washer
12	28	14	50 <sup>2</sup> x 6
14	29	16	50 <sup>2</sup> x6
16	30	18	50 <sup>2</sup> x6
18	32	20	60 <sup>2</sup> x6
20	34	22	60 <sup>2</sup> x6
22	36	24	65 <sup>2</sup> x6
24	40	26	75 <sup>2</sup> x10
27	45	29	75 <sup>2</sup> x10
30	50	32	80 <sup>2</sup> x10
33	55	35	90 <sup>2</sup> x10
36	60	38	90 <sup>2</sup> x10
39	65	42	100 <sup>2</sup> x12
42	70	46	105 <sup>2</sup> x12
45	75	50	110 <sup>2</sup> x12
48	80	54	120 <sup>2</sup> x12

**26.12.8 Inspection of sill beam**

**26.12.8.1** Before erection, center line of the sill beam shall be marked on the pier faces. The center line of the gates shall be inscribed on the crest shifted by 300 mm or so on upstream side. The sill beam center line shall be checked in relation to the trunnion center line.

**26.12.8.2** After erection, the alignment and the angular setting of the sill beam shall be checked. For the angular setting of sill beam 3 to 5 frames may be used.

**26.12.8.3** After aligning the sill beam, all the bolts and nuts shall be put in position. The reinforcement bars and dowels be welded with anchor bolts so that the complete assembly is firmly held in position and is not disturbed during concreting/grouting.

**26.12.8.4** The aggregate used for concreting/grouting shall not be more than 20 mm. The concrete mix shall be hand compacted by using rods. No mechanical vibrators shall be used.

**26.12.9 Inspection of wall plates (side seal seats)**

**26.12.9.1** The wall plates shall be in true alignment with respect to center line of trunnion pin. The dummy trunnion assembly with extension rods shall be used for checking the alignment of wall plates. The verticality of the wall plates shall be checked to ensure that wall plates are truly vertical.

**26.12.9.2** After setting of wall plates, all the bolts and nuts shall be put in position. The reinforcement bars and dowels in the blockout shall be accurately welded to the side seats in such a manner that wall plates are not displaced during concreting or otherwise.

**26.12.9.3** The shuttering planks for concreting the wall plates shall be at least 1.5 to 3 mm clear from the metal parts of wall plate. Maximum aggregate size used for concreting the blockouts shall not exceed 20 mm. All concrete mix shall be hand compacted and done in conversant stages as the shuttering progress in the upward direction. Compaction may be done by 20 mm rods. No mechanical vibrators should be used.

**26.12.10 Inspection of gates**

**26.12.10.1** The sub-assemblies of the gate which are received at site duly inspected in workshop shall be re-inspected at site before lowering of assembly in the bay.

**26.12.10.2** Checking of all dimension of the gate shall be done after skeleton assembly of each gate is made and before final welding/riveting is allowed. This dimensional check shall be repeated after welding is done.

**26.12.10.3** Visual inspection of all welds and bolts/rivets shall be made to the extent of 100 percent.

**23.12.10.4** Following critical dimensions shall be checked :

- a) Centre to center distance between side guide rollers and shoes.
- b) Centre to center distance between the side seal and bases.
- c) Distance to bottom seal/base from center line of trunnion pin.

**26.12.10.5** The seal bolts shall be tightened adequately and uniformly and the guide wheels be checked for free rotation.

**26.12.10.6** To check the effectiveness of the seals, active seal interference shall be compared with that provided in the design, because on this aspect will depend to a great extent the efficiency of sealing arrangement and easy operation of gate.

**26.12.10.7** Inspection of complete gate installation and hoists including electrical items.

**26.12.10.8** Visual inspection of all gates and hoists shall be carried out as per the detailed drawing. It has to be ensured that the erection tolerances have been maintained during and after erection.

**26.12.11** In case of hoists, following point shall be looked into :

- a. Connections like shaft coupling, connections of wire ropes to drum and gate, connections of hoist components to the base etc, have been properly made.
- b. In case of double hoists both hoists are properly synchronized.
- c. Intermediate supports at required intervals are provided to permit free movement of shaft.
- d. The ends of the wire rope are properly looped and sufficient "U" clamps have been provided. The rope has been tightly wound over the drum, has no links and is properly lubricated.
- e. The wire ropes or chains at both ends of the gate and counter weight have equal initial tension.

- f. Electric installations have been properly earthed and the limit switches have been properly adjusted.

**26.12.11.1** The hoist provided for the operation of the gate shall first be independently checked and tested when it is connected to the gate to ensure its satisfactory working.

**26.12.11.2** It shall be ensured that the gate sill, wall plates and other embedded parts are thoroughly cleaned and no foreign matter is present to obstruct the movement of the gate.

**26.12.11.3** Before operation of the gate the following final checks shall be made.

- a. Electrical connections and fuses.
- b. Over load relay, if provided, to see that it trips the starter.
- c. All bearing and wire ropes for proper greasing.
- d. All bolts of gear boxes, hoists drum and shafts, couplings for tightness.
- e. The oil level in gear reduction unit.

**26.12.12 Testing**

**26.12.12.1** The gate shall be tested in a dry condition with hoist duly connected for its smooth working. The gate shall be fully closed or fully opened and it shall be ensured that there is no obstruction and no undue effort required for its operation. If the gate is not going down of its own weight or found tight in some position, reasons shall be investigated and remedied instead of forcing the gate down. While testing the gate in dry condition, the rubber seals should be kept wet by water jetting or suitable methods to avoid damage to the seals.

**26.12.12.2** The testing of gate seals shall be checked in the same manner as explained in case of fixed wheel or slide gates.

**26.12.12.3** Under the designed water head conditions, the leakage through the gate shall not exceed 15 litres/ minute/metre length of the seal.

**26.12.12.4** The gate is to be kept on the sill beam, that is in closed position. The leakage test, (if provided in the terms of execution of work), can be done in the position by using suitable pump with necessary arrangements of jetting water at 1.5 times, the designed pressure, on sealing positions from bottom to top. All joints, if any, shall be tested to ensure perfect working of the gate.



**26.12.12.5** The arrangement provided for preventing the travel of the gate or hoist beyond the designed limit are tested and checked for proper working. The time required for 300 mm opening or closing of the gate shall be recorded for calibration purposes.

**26.12.12.6** The full load current required for the movement of the gate on load shall be measured and checked against the designed value.

**26.12.12.7** When the water starts overflowing, the gate shall be lowered to hold water to half the height of gates. In this position the seals may be tested and any leakage shall be attended. The gate shall be operated up and down under these loading conditions to observe the operation of the hoist. The gate shall also be checked in a similar way against full water load.

**26.12.12.8** Following observations shall be recorded for testing of gate under dry condition and under water pressure.

- a. Movement of gate and indication of jamming if any
- b. Effective stop is achieved by the gate stops wherever provided.
- c. Speed of opening and closing and the current requirement at specified voltage.
- d. Operation of brakes and limit switches.
- e. Manual operation of gate, if provided.
- f. Efficiency of guide rollers to check the side swaying of the gate.
- g. Correctness of indication by local position indicator.
- h. Synchronization of remote position indicators, if provided.
- i. Vibration of gate, hoist and civil structures.

**26.13 Single faced sluice gates (200 to 1200 mm size)**

**26.13.1 General**

These specifications cover the single faced sluices from 200 mm to 1200 mm sizes of different shapes with rising (sliding) and non- rising (rotating) spindles.

**26.13.1.2** The specification is limited to sluices which are suitable for general use only and for the following types of special use :

- a. For wall mounting in situations where small and medium volumes of raw or filtered water, storm water or sewage are to be controlled and a single faced seal is required on the waterway for isolating purposes.
- b. For water supply draw-off and purification works, sewage plants, ordinary land drainage and irrigation canals, hydro-electric collecting aqueducts and tail races.
- c. For unbalanced head restricted to 15 meters, tending to push the door on to the frame and there by helping stanch leakage past sealing face.
- d. For manual operation by hand wheel/toe-key /frame or floor mounting head stocks with or without gearing.

### **26.13.2 Classification**

**26.13.2.1** Single faced sluices are of class 1 or class 2 types. Class 1 covers sluices suitable for a maximum sealing unbalanced head of 6 meters of water. Class 2 covers sluices suitable for maximum sealing unbalanced head of 15 meters of water.

**26.13.2.2** Shapes and types of sluices may be circular, square or rectangular and may either be with rising or non-rising spindle.

**26.13.2.3** Nominal sizes and dimensions. Single faced sluices shall be manufactured according to the nominal sizes and dimensions as given in Table No. 2. Tolerances on the dimensions shall be closely taken into account and the manufacturing shall be as close to nominal dimensions as possible. The range and ratings of different types with rising and non-rising are given in Table No. 3.

### 26.13.3 Materials

Following materials are in use for the manufacture of various components of the gates.

S. No.	Component part	Recommended Material	Reference
1	Frame & door side guide strip	Grade 20 Cast Iron	IS210-1991
2	Spindles, nuts & bolts	Mild steel	IS : 2062-1992
3.	Face, face rings/ trid , spindle nuts.	Gunmetal	IS: 2654-1991

### 26.13.4 Manufacture & Workmanship

#### 26.13.4.1 Frame

**26.13.4.2** The frames shall have a robust spigot of an appropriate length, cast integral at the back for case of support in the waterway and to provide an effective seal sluices having circular opening or waterway may have a spigot dimensions conforming to IS: 1538-1976. For square and rectangular openings the dimensions shall be as per the tendered specifications.

**26.13.4.3** The back of the frame shall be flat. The frame for non-rising sluices shall have a machined face on the top to support the thrust plate.

**26.13.4.4** A cast iron side guide strip having a machined taper face on the underside shall be fixed to the frame on each side by mild steel studs and extending over the height of the waterway to provide effective guide throughout the travel of the door. A stopper shall be casted integrally immediately below the water way and center with it to limit the travel of the door.

#### 26.13.5 Door

**26.13.5.1** Door shall have reinforcement ribs integral at the back for strength. On each side there shall be tapered suns or gunmetal or bronze tape strips not less than three, machined to match similar taper faced side guide strips on the frame.

**26.13.5.2** Two integrally cast lugs drilled to take mild steel bearing pin shall be provided on doors for use with rising spindles. Integrally cast pocket suitably reinforced to accommodate a nut shall be provided on doors with non-rising spindles.

**26.13.5.3** A stopper to match that on the frame shall be casted integrally at the bottom.

**26.13.5.4** Face (Door ) and seat (Frame) rings

**26.13.6.1** Facings for different types of sluices shall conform to the dimensions given in table 4 to 8 read with figures 4A, 4B, 4C, 4D, & 4E.

**26.13.6.2** Facings shall be so secured by brass rivet pins in the machined grooves of the frame and door and machined and hand finished, that with the door fully shut a satisfactory water tight seal is formed on the waterway. The contact between the facings shall be sufficiently close at every point in the perimeter so as to produce a uniform bearing all around.

**26.13.6.3** The attachment of the facings to the frame and door shall be so carried out that when finished they shall remain in place free from distortion or loosening during effective life of the sluice.

**26.13.6.4** Face rings and seat rings used shall be as per shape and sections given below :

S.No.	Sluice gate	Type of section of a face ring	Type of section of seat ring
1	Sluice upto & below 300 mm.	'L' Section	'L' section
2.	Sluices above 300 mm	Rectangular section	Strips/rings of rectangular section

**26.14.1 Guides :**

Guides shall be adequately secured to the main frame by stud bolts and provision shall be made for appropriate longitudinal movement to adjust degree of welding consistent with sealing property. There shall be little lateral movement and tongues, keys, shoulders or lugs may be provided for the purpose.

## 26.14.2 Spindles

**26.14.2.1 Rising/sliding type** – The dimensions shall conform to those specified in table No. 4,6 & 8 and shall terminate at the top of the sluice door and operated through either frame or floor mounted head stock. The threaded portion of the spindle shall be completely clear of the liquid being handled and shall be accessible for lubrication.

**26.14.2.2 Non rising/retaining type-** These shall conform to the dimensions given in table no. 5 & 7 and shall be threaded at the bottom. They shall be restrained axially by a thrust plate on the top of the sluice frame and shall work in a nut located in a pocket on the top center of the door. The screeded portions of the spindles shall have machine cut square or some thread.

**26.14.2.3** The length of rod may vary for each installation, the number of couplings required may be computed from the table No. 9 for lengths exceeding 6 meters, it is recommended that only sliding rods be employed, but if the prevailing conditions do not permit their use the rotating type may be considered.

**26.14.2.4 Thrust bearings** – For non rising spindles, bearing shall be provided in the yoke of the frame of a design that will develop and safely transmit the full thrust at the time of opening or closing the door.

## 26.14.3 Operating mechanism

**26.14.3.1** Provision may be made in the tender specification for operation of sluices by hand, electric, hydraulic or pneumatic power.

**26.14.3.2 Hand Wheels** – For gates having rising or non-rising spindles the diameter of hand wheel is dependent on the factors viz. unbalanced load, type of actuating gear employed (spur or worm), length of operating rod. The diameter of hand wheel suitable for use on ungeared hand stocks are given in table No. 11 for general guidance.

**26.14.3.3** Height of sluices – The overall heights and the dimensions of the sluice frame and doors shall be in accordance with table No. 12

**26.14.3.4** Workmanship- All castings shall be clean, sound and without defect of any kind. They shall be free from sand and no casting shall be burned, plugged, stopped, patched or welded and no repairs of defects shall be permissible. All foundry and machine work shall be done in accordance with best modern practice and all component parts shall be carefully and accurately machined to jigs and templates so as to make, them fully interchangeable on site without any additional work.

**26.14.3.5 Painting** – Immediately after casting and before machining, all cast iron parts shall be thoroughly cleaned and before rusting commences, these shall be coated by at least two coats of bitumastic rust-proof compound of satisfactory quality and specification. The final coats shall be applied shall be applied to the exterior surfaces, excluding machined portion, after assembly and testing.

**26.14.3.6 Testing** – After completion each sluice gate shall be tested in the shop for smooth working of the component parts including operating gear.

## APPENDIX A

## MATERIALS FOR THE COMPONENTS OF FIXED-WHEEL GATES

S. No. (1)	Component part (2)	Recommended materials (3)	Reference (4)
i)	Wheel	Cast steel Cast iron Wrought steels Forged steel	IS : 1030-1989 IS : 210-1991 IS : 1570-1987 IS : 2004-1991
ii)	Bushing	Bronze	
iii)	Wheel pins or axis	Chrome nickel steel or corrosion resisting Steel, mild steel with Nickel or chromium Platting.	IS : 1570-1987 IS : 2004-1991 IS : 2062-1992 IS : 1060-1992 IS : 1337-1991
iv)	Structural parts gate leaf, track base etc.	Structural steel	IS: 2062-1992 IS: 8500-1992
v)	Seal	Rubber	Appendix – F
vi)	Wheel track	a) Stainless steel  b) Corrosion resisting steel  c) Cast steel  d) Structural steel  e) Corrosion resisting  Cast iron Material (a) to (e) may Be specified depending Upon the actual requirements of wheel loads.	IS: 1570(Pt. V) 1991 IS: 1570-1987  IS: 1030-1989  IS: 2062-1992  IS: 2749-1991

S. No. (1)	Component part (2)	Recommended materials (3)	Reference (4)
vii)	Seal seat	Stainless steel plate or stainless steel clad plate	IS: 1570 Pt. V) 1991
viii)	Seal base, seal seat	Structural steel of convenient shape	IS: 2062-1992 IS: 8500-1992
ix )	Seal clamp	Structural steel	IS : 2062-1992
x)	Guide	Structural steel or corrosion resisting steel	IS: 8500-1992 IS : 6527-1992 IS: 6603-1991 IS: 2062 992 IS: 8500-1992 IS: 6603-1991
xi)	Springs	Spring steel	IS: 1570-1987 IS: 6527-1992
xii)	Anchor bolts	Structural steel	IS: 2062-1992 IS: 8500-1992
xiii)	Guide rollers and guide shoes.	Structural steel or corrosion resisting Steel, cast iron, cast steel or forged steel	IS: 2062-1992 IS:8500-1992 IS:210-1991 IS: 1030-1989 IS: 2004-1991

**Note : 1.** Grade of the material conforming to the specifications mentioned above shall be specified by the designer to suit to the particular requirement.

**Note : 2** Cast iron shall not be used for wheel and tracks for high head gates.

Note : 3. The choice of material is governed by the type of installation, accessibility for maintenance, reservoir water properties silt, etc.

1. Specifications for carbon steel castings for general engineering purposes (second revision).
2. Specifications for grey iron castings (second revision)
3. Schedule for wrought steels for general engineering purposes.
4. Specifications for carbon steel forgings for general engineering purposes (first revision)
5. Specifications for structural steel (Standard quality) (first revision)
6. Specifications for structural steel (Fusion welding quality) (second revision)
7. Electroplated coatings of nickel and chromium on iron and steel (First revision).
8. Specifications for hard chromium coatings on iron and steel (first revision)
9. Weld able structural steel, medium and high strength quality.
10. Specifications for stainless and heat resisting steels (First revision)
11. Specifications for stainless iron castings (First revision)
12. Specifications for stainless steel wire rod.
13. Specifications for stainless steel bars and flats.



## APPENDIX – B

**RECOMMENDED MATERIALS FOR VARIOUS COMPONENTS  
(FOR LOW HEAD SLIDE GATES)**

The recommended materials for various components are given below :

- |    |                           |                           |
|----|---------------------------|---------------------------|
| a) | Gate leaf                 |                           |
|    | Cast iron                 | IS: 210-1991              |
|    | Structural steel          | IS: 2062-1992             |
|    |                           | IS: 8500-1992             |
|    | Cast Steel                | IS: 1030-1989             |
| b) | Gate frames               |                           |
|    | Cast iron                 | IS: 210-1991              |
|    | Structural steel          | IS: 2062-1992             |
|    |                           | IS: 8500-1992             |
| c) | Seal Plates/Seals         | IS: 306-1988              |
|    | Bronze                    | IS: 1458- 1991            |
|    |                           | IS: 318-1991              |
|    | Brass                     | IS: 291-1989 (Grade I)    |
|    | Wood                      | (commercial good quality) |
|    | Stainless steel           | IS: 1570 (Pt. V) 1991     |
|    |                           | IS: 6911-1992             |
|    | Rubber                    | Appendix F                |
| d) | Seal seats/Bearing Plates |                           |
|    | Bronze                    | IS: 306-1988              |
|    |                           | IS: 318-1991              |
|    |                           | IS: 1458-1991             |

Brass	IS: 291-1989 (Grade I)
Steel	IS: 226-1992
	IS: 8500-1992
	IS: 2062-1992
Cast iron	IS: 210-1991
Stainless steel clad plate or	IS: 6911-1991
Stainless steel	IS: 1570-(Pt. V) 1991
c) Guides	
Structural steel	IS: 2062-1992
	IS: 8500-1992
Corrosion resisting steel	IS: 6603-1991
1. Specifications for grey iron castings (second revision)	
2. Specifications for structural steel (Standard quality) (Fifth revision)	
3. Specifications for structural steel (Fusion welding quality) (second revision)	
4. Specifications for weld able structural steel, medium and high strength quality.	
5. Specifications for carbon steel castings for general engineering purposes (second revision)	
6. Specifications for tin bronze (second revision) ingots and castings.	
7. Specifications for loaded tin bronze ingots and castings (Revised)	
8. Specifications for railway bronze ingots and castings (Revised)	
9. Specifications for naval brass rods and sections (Suitable for machining and gorging (Second revision.))	
10. Schedules for wrought steels Part V Stainless and heat resisting steels (first revision)	
11. Specifications for stainless steel plate, sheet and strip.	
12. Specifications for stainless steel bars and flats.	

## APPENDIX - C

## MATERIALS FOR PARTS OF THE RADIAL GATES.

S.No.	Component part.	Recommended materials	Reference
i)	Skin plate, stiffners, horizontal girders, arms bracings, tie members anchorage girder, yoke girder, embedded girder rest girder, load carrying anchors.	Structural steel	IS:808-
1989			IS:2062-
1992			IS:8500-
1992			
ii)	Guide rollers	Cast steel	IS:1030-
1989			IS:2062-
1992		forged steel	IS:1875-
1992			IS:1004-
1991			
1987			IS:1570-
	Cast steel	IS:210-	
1991			
iii)	Trunnion, hub and bracket	Cast steel	IS:1030-
1989			IS:2062-
1992			
iv)	Pin	Structural steel*	IS:2062-
1992			IS:8500-
1992		Cast Steel*	IS:1030-
1989			IS:1875-
1971			IS:2004-
1991			

## 26-60

1987		Corrosion resisting steel	IS:1570-
v)	Bushing	Bronze	
vi)	Seal seat, sill beam	Stainless steel plate or or stainless steel, clad plate.	IS:1570 (Pt.V)-
1991			
vii)	Seal base and base	Structural steel	IS:2062-
1992			IS:8500-
1992			
viii)	Seal	Rubber	Appendix -
F			

**Note 1 -** Grade of the material conforming to specification mentioned above shall be specified by the designer to suit the particular requirement.

**Note 2 -** Where materials marked with \* are used for making pins, they will be electroplated with chromium in accordance with IS:1068-1968

1. Specifications for structural steel standard quality (First revision).
2. Specifications for rolled steel beam, channel and angle sections (revision).
3. Specifications for structural steel (fusion welding quality) (first revision).
4. Weldable structural steel (medium and high strength qualities).
5. Specifications for carbon steel coatings for general engineering purposes (second revision)
6. Specifications for carbon steel forgings for general engineering purposes (first revision).
7. Specifications for carbon steel billets, blooms, slabs and bars for forgings (fourth revision).
8. Schedule for wrought steels for general engineering purposes.
9. Schedule for wrought steels for general engineering purposes: Part V  
Stainless and heat-resisting steels (first revision)
10. Specifications for grey iron casting (second revision)
11. Electroplated coatings of nickel and chromium on iron and steel (first revision)

## APPENDIX – D

## TOLERANCES FOR EMBEDDED PARTS AND IN COMPONENTS OF GATE.

## (FOR FIXED WHEEL AND LOW HEAD SLIDE GATES)

Components	Classification	
	Low And medium Head	High Head
(1)	(2)	(3)

## A. Embedded Parts.

1	Track Plates		
1.1	Alignment in plane parallel to flow	+1.0	+0.5
1.2	Distance between center line	+1.5	+1.0
1.3	Coplanerness	+1.0	+0.5
2	Guide		
2.1	Alignment in plane parallel	+1.0	+1.0
2.2	Distance between center line	+1.0	+1.0
3.	Side Seal Seats		
3.1	Alignment in plane parallel	+2.0	+1.0
3.2	Distance between center line	+1.5	+1.0
3.3	Coplanerness	+1.0	+0.5

Classification		
Components (1)	Low and medium Head (2)	High Head (3)
4	Top Seal Seat	
4.1	Alignment	+2.0
4.2	Weight above sill	+3.0
4.3	Coplanerness with aids steel	+1.5
5.	Critical Dimensions	
5.1	Centre to center distance between track plates	+3.0
5.2	Centre to center distance between side seal seats	+3.0
5.3	Face to face distance between guides	+2.0
5.4	Face to track to face of aids Seal seat	-1.0
		+0.0
5.5	Face of track to center line of guide	+2.5
6	Gate	
1	Wheels	
1.1	Alignment of treads in Zero eccentricity position	1.5

---

**Classification**

---

Components (1)	Low and med. Head (2)	High Head (3)
2.	Side and Top Seal Base	
2.1	Alignment	$\pm 1.0$
2.2	Coplanerness	$\pm 0.5$
3	Critical Dimensions	
3.1	Centre to center distance between seal bases	$\pm 1.0$
3.2	Centre to center distance between center line wheel treads.	$\pm 2.0$
3.3	Face to face distance between faces of guide shoes or guide rollers.	$\pm 1.0$
3.4	Face to face distance between wheel tread to side seal base	$\pm 2.0$ $- 0.0$
3.5	Distance between faces of wheel tread and center line of guide shoe/roller	$\pm 2.0$ $\pm 1.2$

**APPENDIX - E**  
**TOLERANCE FOR EMBEDDED PARTS AND COMPONENTS OF GATE**  
**(FOR RADIAL GATES)**

<b>COMPONENTS</b>	<b>TOLERANCES</b>
<b>A. EMBEDDED PARTS</b>	
1) Wall Plante and Still Plate	+ 0.00
a) Distance between centre line of opening and face of wall plate at sill end	0.00 mm - 2.00 mm
b) Distance between centre line of opening and face of wall plate at top end.	+ 2.00 mm - 0.00 mm
c) Straightness of face of wall plates and smooth sill plates	Offset at joints to be ground
d) Normally face of wall plate to gate sill and centre line of trunnion bearings.	$\pm 0.01$ - 0.00
e) Alignment of sill plate in horizontal plane.	$\pm 0.25$ mm
<b>B. COMPONENTS OF GATE</b>	
1) Guide Roller/Guide Shoe	
a) Distance between centre line of gate and face of guide roller/guide shoe	$\pm 1.0$ mm
b) Horizontality of centre lines of both the trunnion bearings.	$\pm 0.25$ mm
c) Parallel distance of centre line of both the trunnion bearings from upstream bottom	$\pm 0.25$ mm
d) Tolerances in diameters of pin bush hub and, bracket of trunnion assembly	To suit diameter and required fits
2) Side seal	
a) Distance between centre line of gate and face of side seal.	$\pm 1.0$ mm
3) Trunnion Bearing	
a) Colinearing of lines of both the trunnion bearings.	$\pm 0.25$ mm



## APPENDIX - F

## SPECIFICATIONS FOR RUBBER FOR SEAL

## DETAILS OF SPECIFICATIONS (As per IS 11855 - 1990)

The rubber seals shall be moulded from natural or synthetic rubber containing not less than one percent by weight of copper inhibitor, and shall have the following physical properties:

- a) Minimum Shore A durometer hardness .....65+5
- b) Minimum elongation .....450 percent
- c) Ultimate tensile strength (minimum) .....14.5 N/mm<sup>2</sup>
- d) The rubber compound shall not absorb more than 10 percent by weight of water in a 7 days test and
- e) The tensile strength of the test specimen, after being subjected to an acceleration against test of 48 hours in oxygen at 70 c and 2.1 N/mm<sup>2</sup> pressure, shall not be less than 80 percent of the strength of the test specimen before ageing.

**TYPES OF RUBBER SEALS RECOMMENDED FOR DIFFERENT CLASSES OF GATES.**

- a) High Head – double atom type (preferably with cladding)
- b) Medium head – solid bulb note type, and
- c) Low Head – hollow/solid bulb music note type or flap or premoulded L-type

**Note -** Wedges type seal may be used at the bottom of the gate when it comes to rest on the sill. If the gate slides on the face of an opening, musical note or double atom type seals may be used.

## TYPES OF SEALS USED IN RADIAL GATES.

The types of seals to be used for various classes of gates shall be as follows:

- a) For crest gates the following types maybe used.
  1. Side seals :
    - i) Hollow bulb music note type,
    - ii) Solid bulb music note type, and
    - iii) I - shaped type.
  2. For bottom seals, the wedges type may be used.
- b) For conduit gates the following types are recommended.
  1. Side and top seals - The seals may be of the session type and my preferably be fixed to the embedded metal of gate and pressurized by reservoir water to ensure better sealing. The seals may be of plain rubber or of rubber clad with brass, bronze fluoro-carbon or stainless steel.
  2. Bottom seal - Wedge type seal may be used.

**TABLE 1: HOLES AND WASHERS FOR ANOTHER BOLTS  
(RADIAL GATES)**

(All dimensions in millimeters)

<b>BOLT DIA</b> <b>(mm)</b>	<b>HOLE IN MEMBER</b> <b>DIA</b> <b>(mm)</b>	<b>HOLE IN WASHER</b> <b>WASHER</b> <b>DIA</b> <b>(mm)</b>	<b>WASHER</b>
12	28	14	50 <sup>2</sup> x 6
14	29	16	50 <sup>2</sup> x 6
16	30	18	50 <sup>2</sup> x 6
18	32	20	60 <sup>2</sup> x 6
20	34	22	60 <sup>2</sup> x 6
22	36	24	65 <sup>2</sup> x 6
24	40	26	75 <sup>2</sup> x 10
27	45	29	75 <sup>2</sup> x 10
30	50	32	80 <sup>2</sup> x 10
33	55	35	90 <sup>2</sup> x 10
36	60	36	90 <sup>2</sup> x 12
39	65	42	100 <sup>2</sup> x 12
42	70	46	105 <sup>2</sup> x 12
45	75	50	110 <sup>2</sup> x 12
48	80	54	120 <sup>2</sup> x 12

**TABLE 2: NOMINAL SIZES AND DIMENSIONS OF SINGLE FACED SLUICES.**

<b>SHAPE (1)</b>	<b>SIZE (2)</b>	<b>REF. TO FIG. (3)</b>
Circular	200 to 600	4A(1), 4B(1)
	200 to 1200	4C(1), 4D(1)
Square	200 to 600	4A(2), 4B(2)
	200 to 1200	4C(2), 4D(2)
Rectangular	300 x 375 to 1200 x 1050	4E

**TABLES 3 : RANGE AND RATING OF SLUICES  
(with rising and non - rising spindles)**

<b>CLASS (1)</b>	<b>SPINDLE TYPE (2)</b>	<b>SIZE (3)</b>	<b>WATER PRESSURE (SEATING)IN M HEAD MAX. (4)</b>	<b>REFERENCE TO FIG. (5)</b>
1	Rising	200 to 300	6	4A(1)and 4A(2)
		350 and 450	4.5	
		500 to 600	3	
1	Non rising	200 to 300	6	4B(1)and 4B(2)
		350 and 450	4.5	
		500 to 600	3	
2	Rising	200 to 1200	15	4B(1)and 4B(2)
2	Non rising	200 to 1200	15	4D(1)and 4D(2)
2	Rising	300 x 375 to	15	

1050 x 1200

**TABLE 4: DIMENSIONS OF FACINGS AND SPINDLE DIAMETER  
CIRCULAR AND SURFACE SINGLE FACED SLUICES**

**FIG.- 4 (A)**

(ALL dimensions in millimeters)

WATERWAY CIRCULAR OR SQUARE	FACE THICKNESS		FACE BREADTH		RISING X	SPINDLE DIAMETER r
	x	r	x	r		
(1)	(2)	(3)	(4)	(5)	(6)	(7)
200	4	5	16	16	30	30
250	4	5	20	20	30	40
300	5	5	20	20	40	40
350	6	6	20	20	40	40
450	6	6	20	20	45	40
500	6	6	22	22	45	50
550	6	6	22	22	50	50
600	6	6	22	22	50	55

X = Circular waterway

r = Square waterway

**TABLE 5 - DIMENSIONS OF FACINGS, SPINDLE DIAMETERS AND  
DIMENSIONS OF TAPERED SQUARE ON SPINDLES FOR  
CIRCULAR AND SQUARE SINGLE FACED SLUICES  
(FIG. 4B)  
(All dimensions in millimeters)**

	WATERWAY FACE THICKNESS		FACE BREADTH		DIA METER	TAPERED SQUARE SPINDLE NON-RISING		
	X	r	X	r		Top	Bottom	Length
(1)	(2)	(3)	(4)	(5)	(6)	(7)	(8)	(9)
200	4	5	16	16	35	22	27	50
250	4	5	20	20	35	22	27	50
300	5	5	20	20	35	22	27	50
350	6	6	20	20	45	24	29	50
450	6	6	20	20	45	24	29	50
500	6	6	22	22	50	29	29	65
550	6	6	22	22	50	29	29	65
600	<b>6</b>	6	22	22	50	29	29	65

X - Circular waterway  
r - Square waterway

**TABLE 6: DIMENSIONS OF FACINGS AND SPINDLE DIAMETER  
CIRCULAR AND SURFACE SINGLE FACED SLUICES  
(FIG.- 4 C)  
(ALL dimensions in millimeters)**

WATERWAY CIRCULAR OR SQUARE	FACE THICKNESS		FACE BREADTH		RISING X	SPINDLE DIAMETER r
	x	r	x	r		
(1)	(2)	(3)	(4)	(5)	(6)	(7)
200	4	5	20	20	32	32
250	4	6	20	25	32	40
300	4	6	25	25	40	40
450	6	6	25	25	45	48
600	6	6	25	25	50	55
750	6	6	25	25	55	58
825	6	6	25	25	58	58
900	6	6	25	25	58	60
1050	6	6	32	32	60	65
1200	6	6	32	32	65	65

X = Circular waterway

r = Square waterway

**TABLE 7 - DIMENSIONS OF FACINGS, SPINDLE DIAMETERS AND  
DIMENSIONS OF TAPERED SQUARE ON SPINDLES FOR  
CIRCULAR AND SQUARE SINGLE FACED SLUICES  
(FIG. 4D)**

(All dimensions in millimeters)

	WATERWAY FACE THICKNESS		FACE BREADTH		DIA METER	TAPERED SQUARE SPINDLE NON-RISING		
	X	r	X	r		Top Sqr	Bottom Sqr	Length
(1)	(2)	(3)	(4)	(5)	(6)	(7)	(8)	(9)
200	4	5	20	20	35	22	27	50
250	4	6	20	25	40	22	27	50
300	6	6	25	25	40	22	27	50
450	6	6	25	25	50	35	42	67
600	6	6	25	25	58	35	42	67
750	6	6	25	25	58	35	42	67
825	6	6	25	25	58	35	42	67
9000	6	6	25	25	58	35	42	67
1050	6	6	32	32	65	40	46	75
1200	6	6	32	32	65	40	46	75

X - Circular waterway

r - Square waterway



**TABLE 8 - DIMENSIONS OF FACINGS, SPINDLE DIAMETERS  
FOR RECTANGULAR SINGLE FACED SLUICES (FIG 4E)  
(All dimensions in millimeters)**

<b>WATERWAY Width (A)x Depth (A2) (1)</b>	<b>FACE THICKNESS  (2)</b>	<b>FACE BREADTH  (3)</b>	<b>SPINDLE RISING DIA. (4)</b>
300 x 375	6	25	40
450 x 300	6	25	45
375 x 450	6	25	47
525 x 375	6	25	47
450 x 525	6	25	50
600 x 450	6	25	50
525 x 600	6	25	53
675 x 525	6	25	53
600 x 675	6	25	53
750 x 600	6	25	53
675 x 750	6	25	55
825 x 675	6	25	55
750 x 825	6	25	55
900 x 750	6	25	60
825 x 900	6	25	60
1050 x 900	6	30	62
900 x 1200	6	30	62
1200 x 900	6	30	62
1050 x 1200	6	30	62
1200 x 1050	6	30	62

**TABLE 9 : CLASS 1 AND CLASS 2 SLUICES - COUPLINGS FOR RISING AND NON-RISING SPINDLES AND WALL BRACKETS FOR NON-RISING SPINDLES.**

---

DISTANCE BELOW BASE OF HEADSTOCK m	COUPLINGS No.
Up to 3.5	0
Over 3.5 to 8	1
Over 8 to 12.5	2
Over 12.5 to 17	3
Over 17 to 21.5	4
Over 21.5 to 26	5
Over 26 to 30.5	6

---

**NOTE -** Where the length of rod below base of headwork exceeds 3.5 m, one coupling is required and for every 4.5 m thereafter, an additional coupling. The table is intended to facilitate calculation.

---

**TABLE 10 : WALL GUIDE BRACKETS FOR TENSION RODS**

<b>DISTANCE BELOW BASE OF HEADSTOCK m</b>	<b>BRACLETS No.</b>
Upto 2	Nil
Over 2 to 3.5	1
Over 3.5 to 6.5	2
Over 6.5 to 9.5	3
Over 9.5 to 12.5	4
Over 12.5 to 15.5	5
Over 15.5 to 18.5	6
Over 18.5 to 21.5	7
Over 21.5 to 24.5	8
Over 24.5 to 27.5	9
Over 27.5 to 30	10

NOTE : Wall guide brackets are required for tensional rods at a maximum of 4.5 m centres, and for tensional rods at a maximum of 3 m centres, the distance to the top most guide bracket not exceeding 4 m and 2 m respectively below base of headstock. However, for tensional rods more than 3 m in length, the distance of the topmost guide bracket below the headstock base is generally reduced to one foot, and the rod and bracket are arranged to eliminate tensional strain in the rod.

**TABLE 11 : DIMENSIONS OF HAND WHEELS FOR USE ON UNGEARED HEADSTOCKS AND DETAILS OF LENGTHENING RODS.**

(All dimensions in mm)

WATERWAY,	CLASS 1 (FIG 4A & 4B)				CLASS 2 FIG.4C, 4D&4E	
	Type of spindle used	H/W Dia.	Rod Dia.	Type of Dia.	H/W Dia	Rod. Dia.
(1)	(2)	(3)	(4)	(5)	(6)	(7)
200 Dia	NR	375	30	NR	375	30
	R	225	28	R	225	30
200 square	NR	375	35	NR	375	35
	R	225	28	R	225	30
250 Dia	NR	375	35	NR	375	35
	R	225	28	R	225	30
250 square	NR	350	38	NR	600	38
	R	375	38	R	375	38
300 Dia 300 x 375 Rect	NR	450	38	NR	600	40
	R	375	38	R	375	38
300 square	NR	600	40	NR	750	40
	R	375	38	R	450	38
350 Dia	NR	600	40	NR	750	40
	R	375	38	R	450	38
350 square	NR	600	45	-	-	-
	R	375	38	R	525	38
450 Dia 375 x 450 Rect	NR	750	47	-	-	-
	R	450	45	R	675	45
450 square	NR	750	47	-	-	-
	R	450	45	R	525	45
500 Dia 525 x 375 Rect	NR	750	47	-	-	-
	R	450	45	R	252	45
500 square	R	600	45	R	750	45
550 Dia 450 x 525 Rect	NR	750	50	-	-	-
	R	525	45	R	600	45

26-77

550 square	R	750	-	R	600	-
600 Dia 600 x 450 Rect	R	600	45	R	750	45
600 square	R	750	50	Ungear- ed head cannot be R	stock used 900	50
650 Dia 600 x 525 Rect 675 x 525 Rect	R	750	50			
650 square 600 x 675 Rect	R	750	50	Ungear- ed head cannot be -do-	stock used	
700 Dia	R	750	50	-do-		
700 square	R	750	50	-do-		
750 Dia 750 x 600 Rect 675 x 750 Rect	R	750	50	-do-		
825 Dia 750 square 825 x 675 Rect	R	900	50		Ungear- ed head cannot be used	stock
NR -Non rising	R-Rising	H/W Hand Wheel.				

NOTE; Ungear- ed headstock will not be suitable for higher sizes.

**TABLES 12: HEIGHTS OF SINGLE FACED SLUICES**

(All dimension in mm)

**a) CLASS 1 FOR A MAXIMUM SEATING UNBALANCED PRESSURE OF 6M HEAD**

SIZE OF WATERWAY Figure 4A (1) or 4A (2)	HEIGHT OF FRAME Rising Type
200	615
250	720
300	845
350	1010
450	1210
500	1350
550	1450
600	1550
Figure 4B(1) or 4B(2) Non rising types	
200	730
250	835
300	960
350	1120
450	1315
500	1475
550	1580
600	1675

<b>SIZE OF WATERWAY</b>	<b>FIG 4C (1) OR 4C(2) Rising types, Height of Top of Frame from Invert</b>	<b>Fig 4D(1) or 4D(2) Non- rising types, Height of Frame</b>
200	700	700
250	700	700
300	800	800
450	1130	1130
600	1445	1445
750	1765	1765
825	1920	1920
900	2070	2070
1050	2425	2565
1200	2715	2880

SIZE OF WATERWAY WIDTH x DEPTH	HEIGHT OF FRAME (Figure 4D ) Rising Type
300 x 375	975
450 x 300	800
375 x 450	1130
525 x 375	975
450 x 525	1280
600 x 450	1130
525 x 600	1445
675 x 525	1280
600 x 675	1600
750 x 600	1450
675 x 750	1765
825 x 675	1600
750 x 825	1920
900 x 750	1765
825 x 900	2070
1050 x 900	2070
900 x 1050	2450
1200 x 900	2070
900 x 1200	2715
1200 x 1050	2450
1050 x 1200	2715



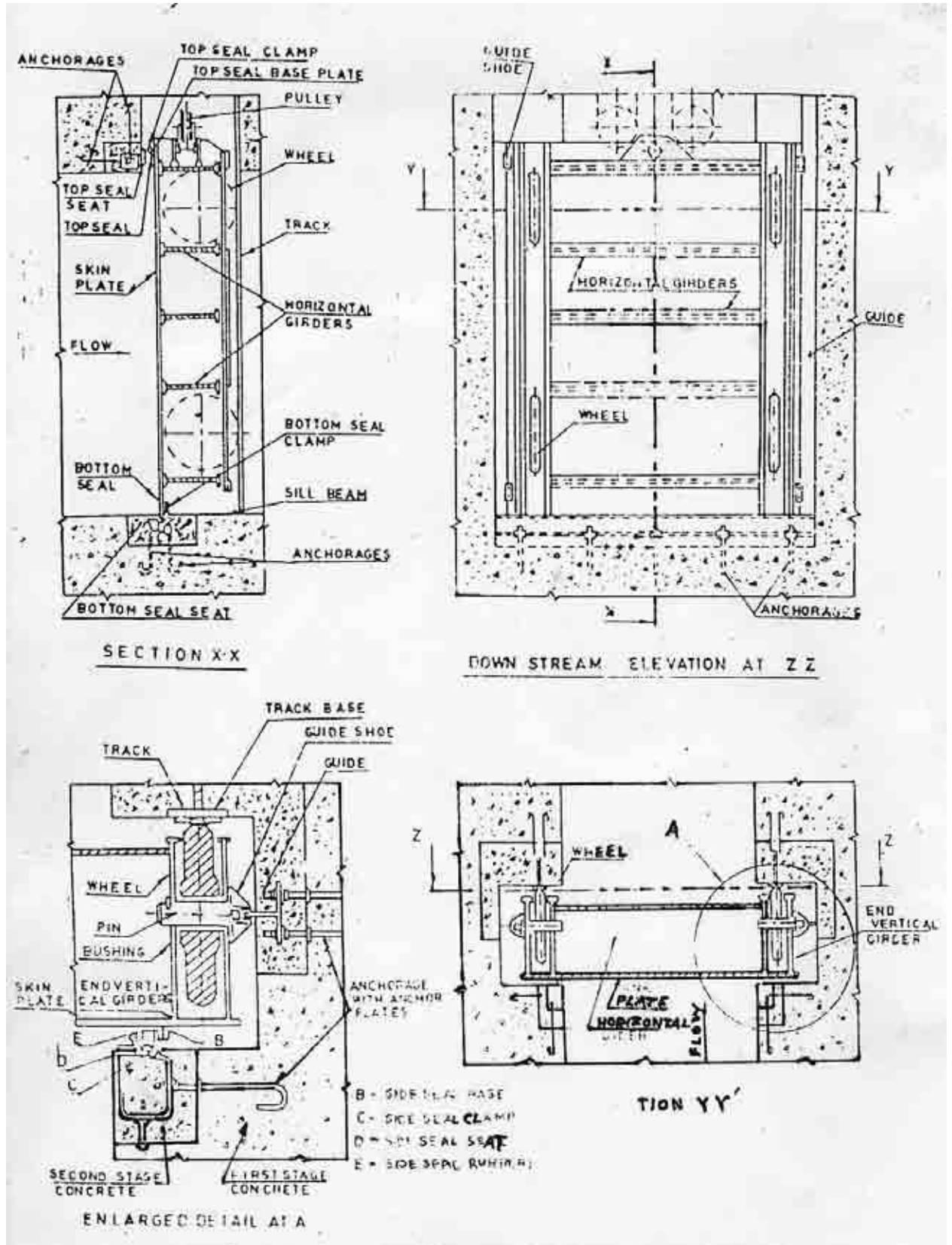
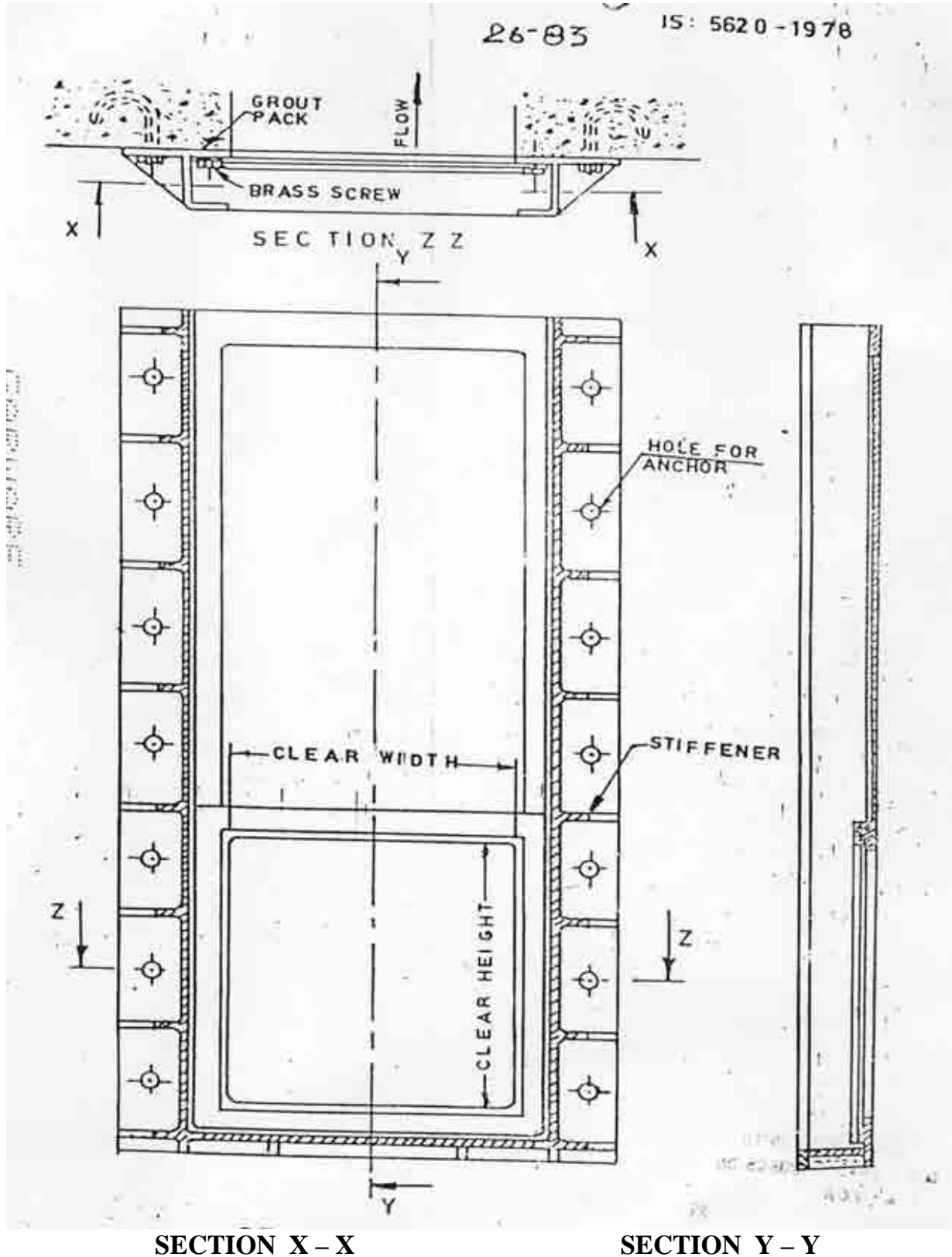

FIG. - 1 TYPICAL ARRANGEMENT OF VARIOUS COMPONENTS OF FIXED WHEEL GATES



**FIG. 2A TYPICAL DIAGRAM SHOWING LOW HEAD SLIDE GATE  
(FULL FACE GATE FRAME)**

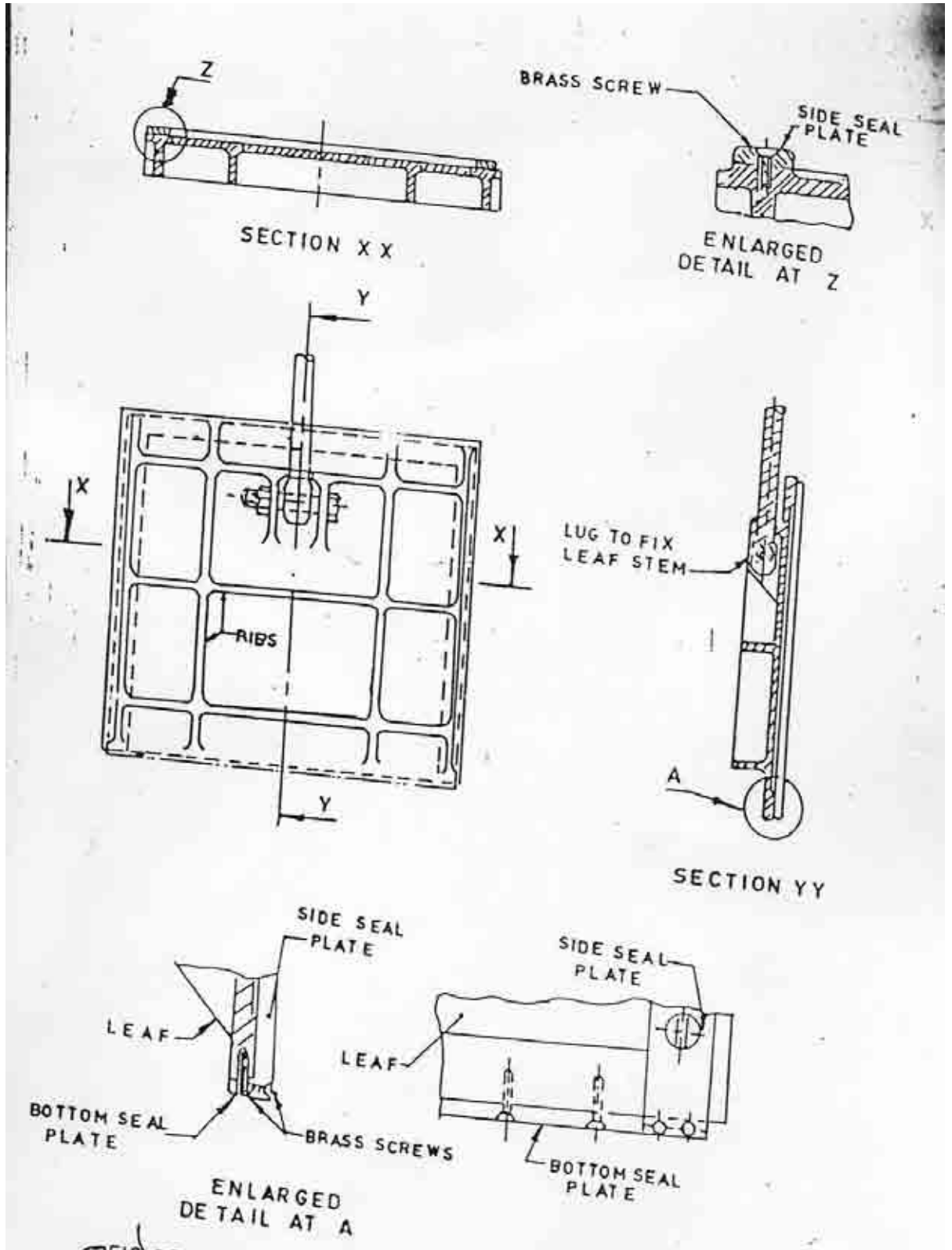

FIG. 2B. TYPICAL DIAGRAM SHOWING LOW HEAD SLIDE GATE LEAF

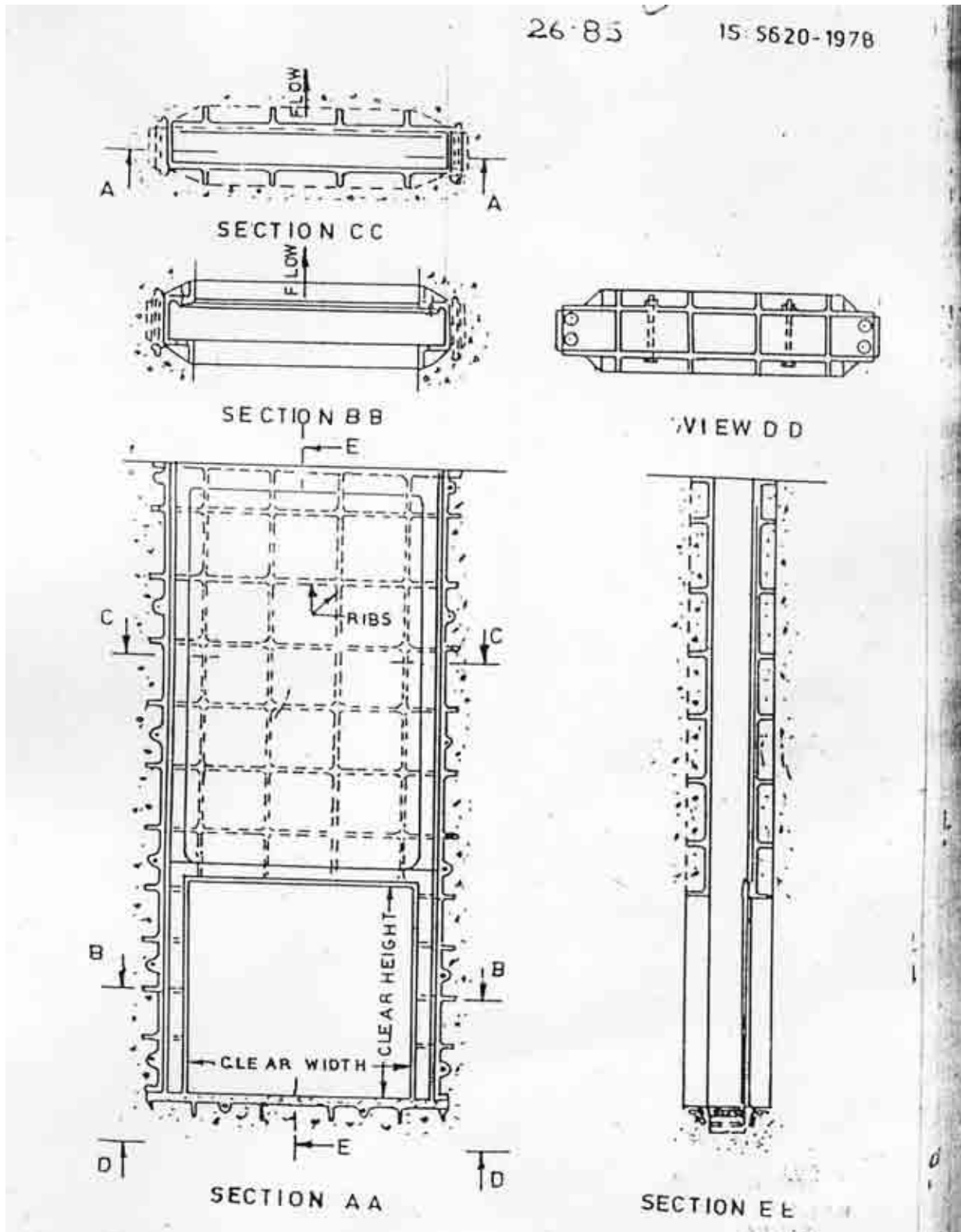
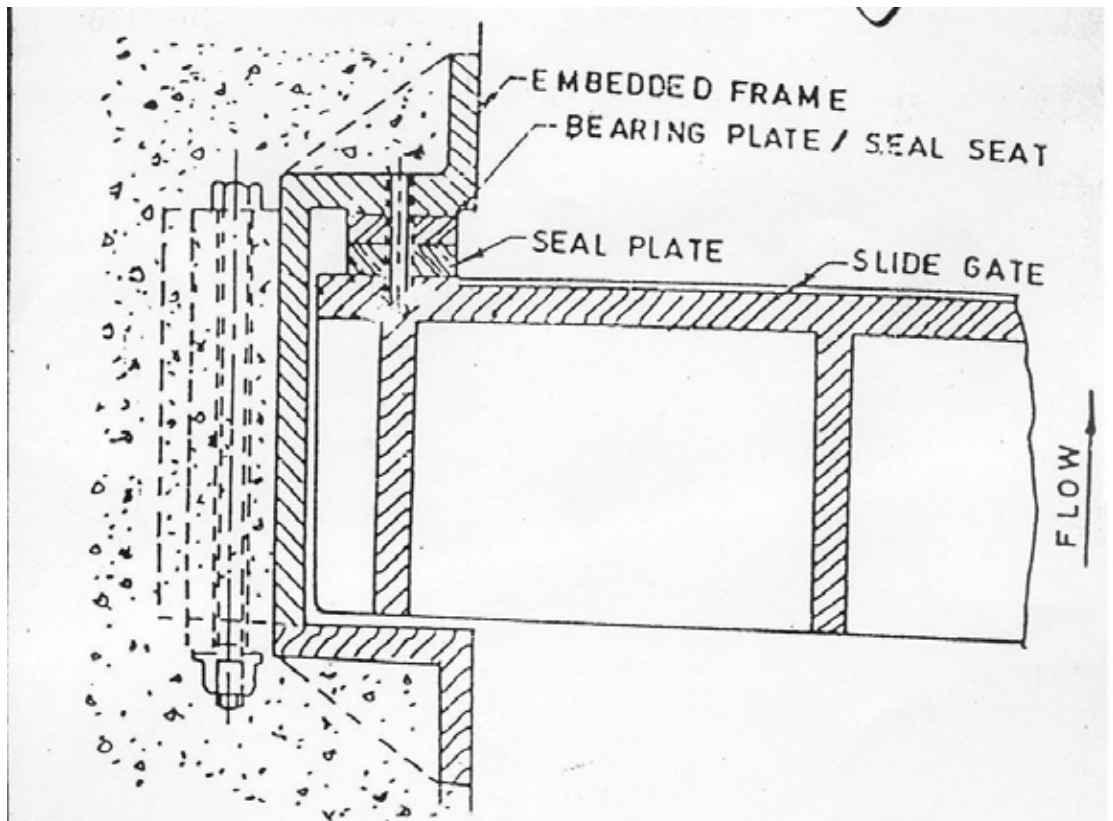
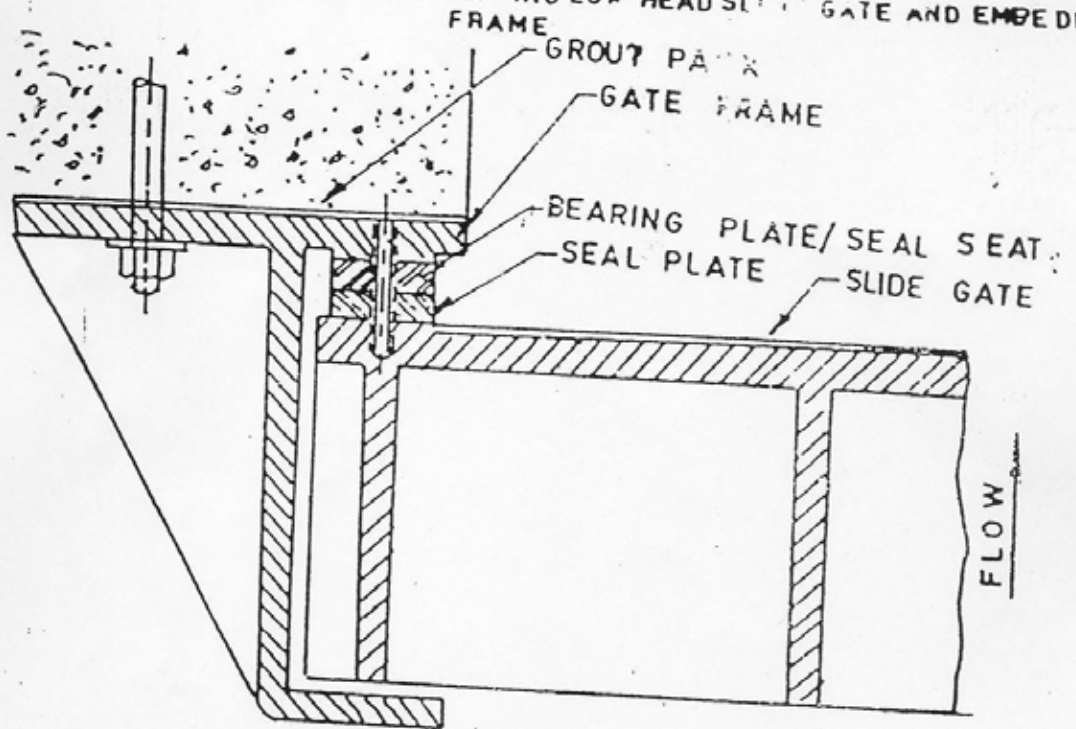

FIG. 2C. TYPICAL DIAGRAM SHOWING EMBEDDED FRAME OF LOW HEAD SLIDE GATE



TYPICAL SLOT SECTION DETAIL SHOWING LOW HEAD SLIDE GATE AND EMBEDDED FRAME



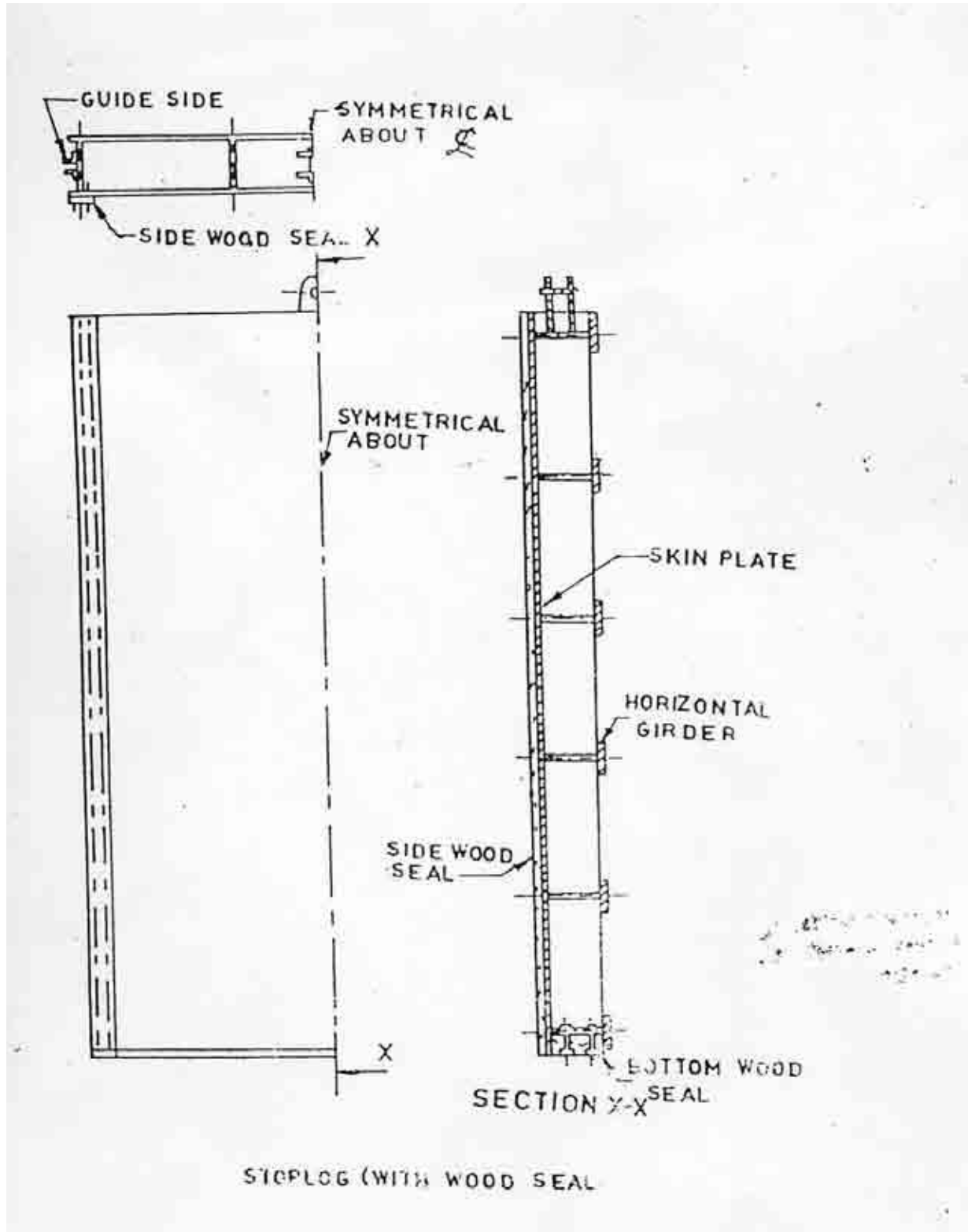

FIG. 2F. LOW HEAD SLIDE GATE SEALING ARRANGEMENT

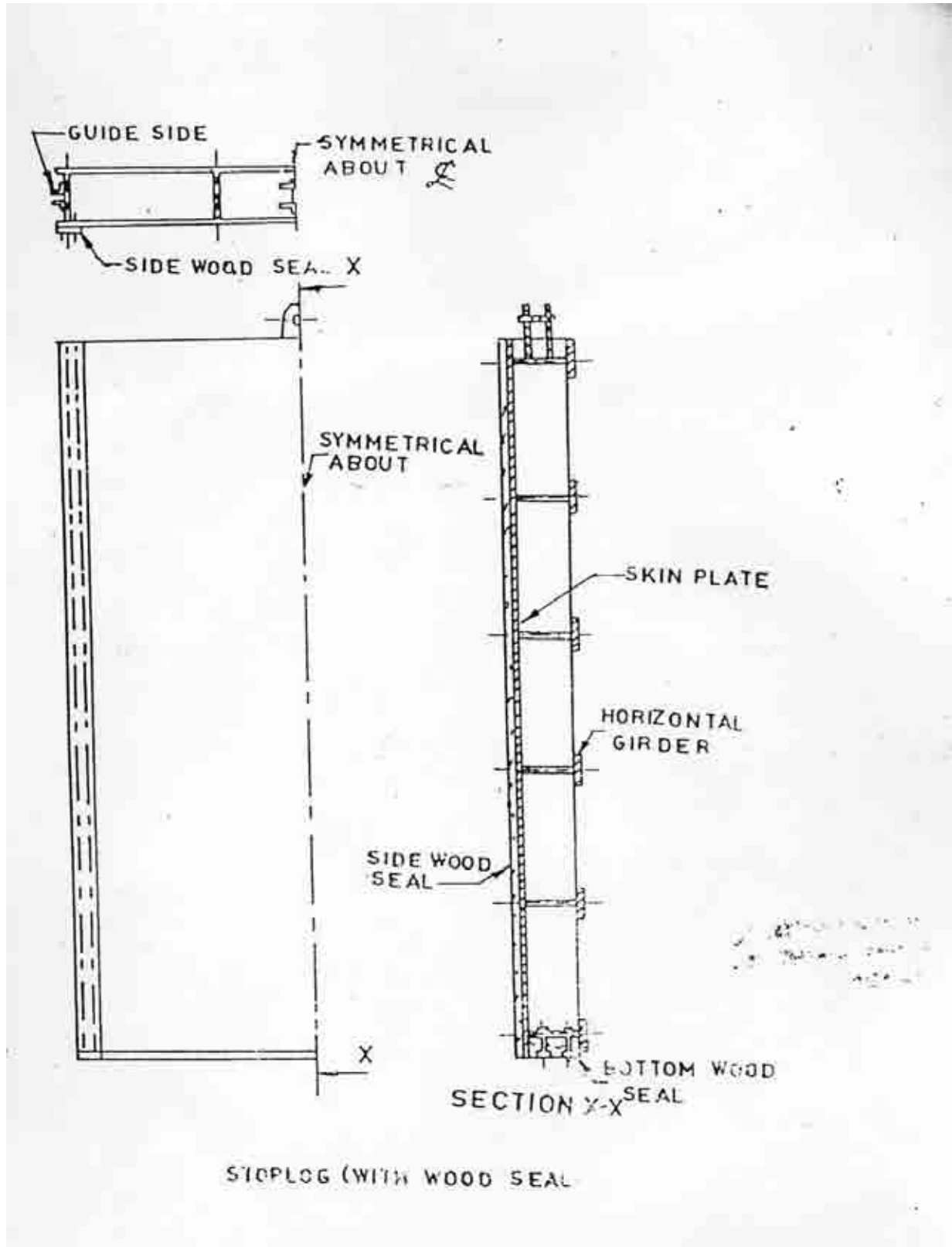

FIG. 2E. LOW HEAD SLIDE GATE SEALING AND ARRANGEMENT

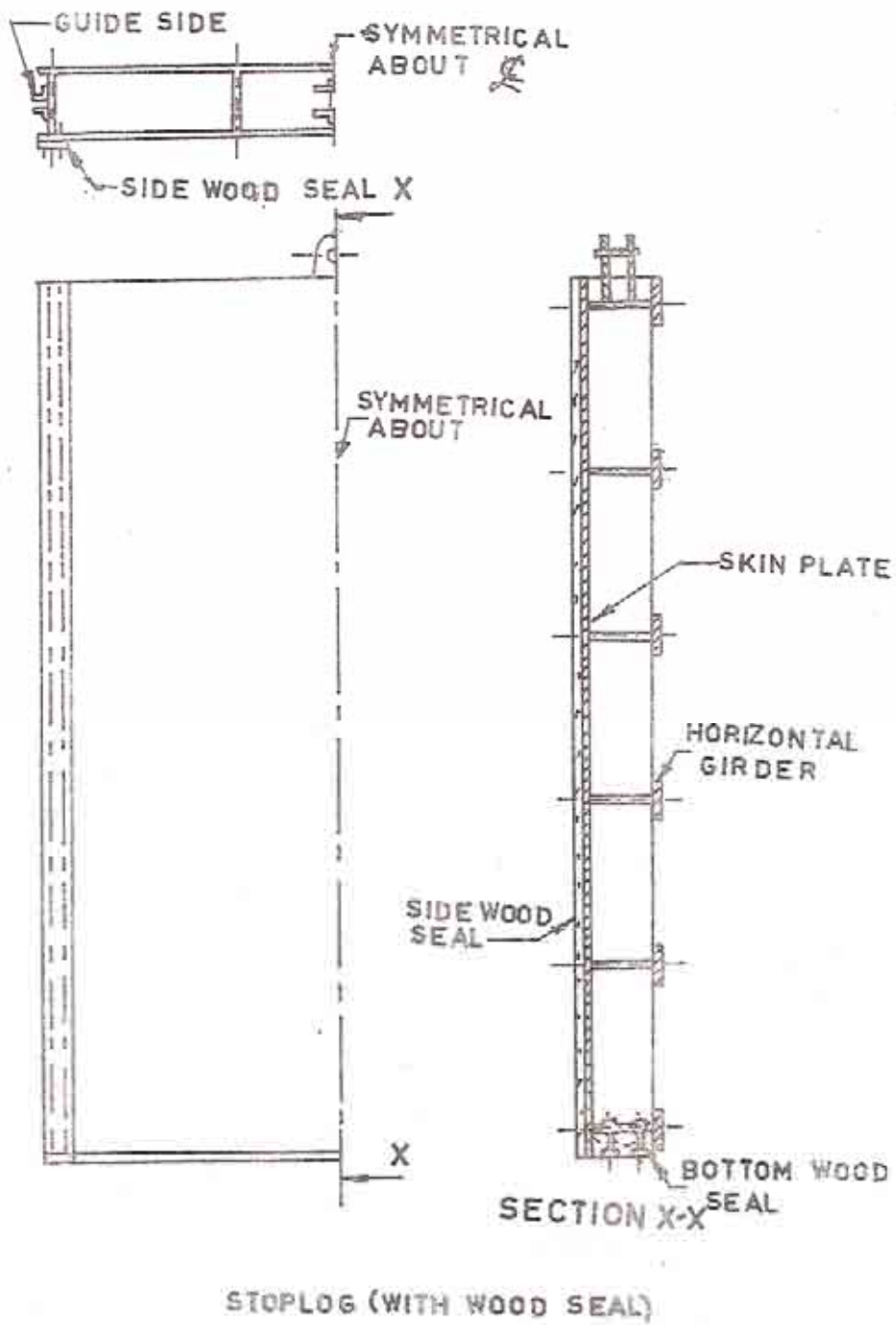
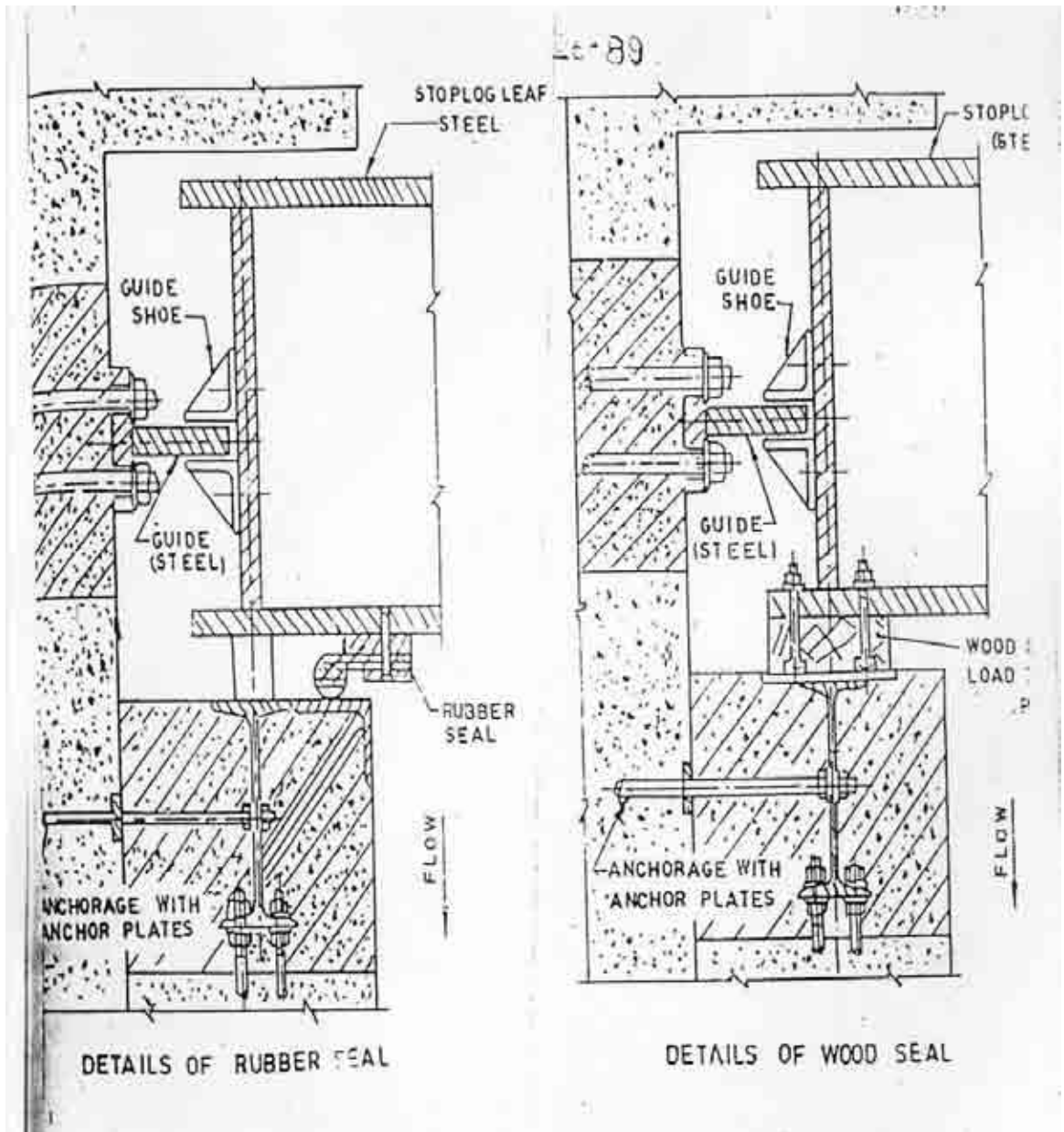

FIG 2F LOW HEAD SLIDE GATE SEALING ARRANGEMENT



FIG. 2G. LOW HEAD SLIDE GATE SEALING ARRANGEMENT



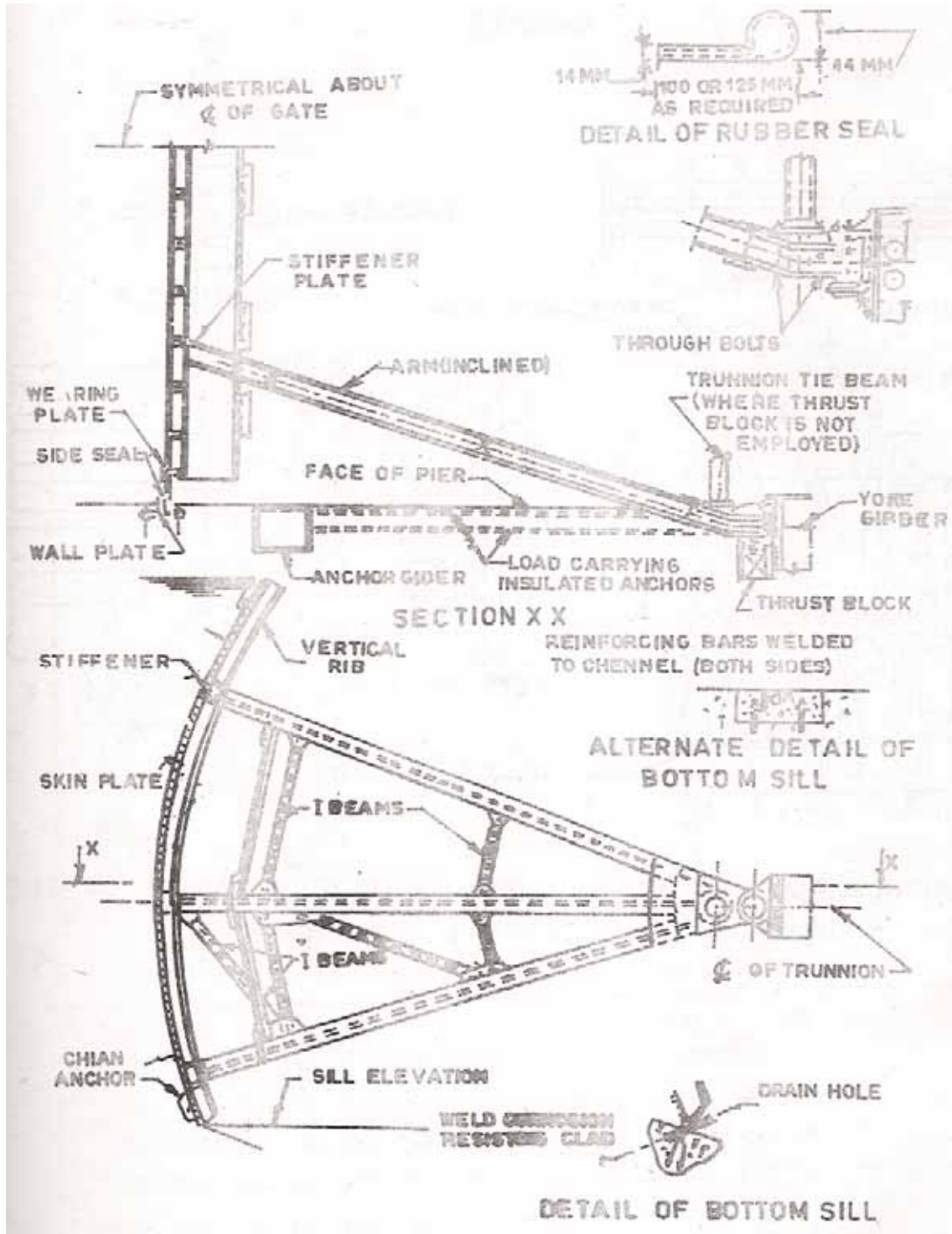

FIG. 3B. RADIAL GATE WITH INCLINED ARM

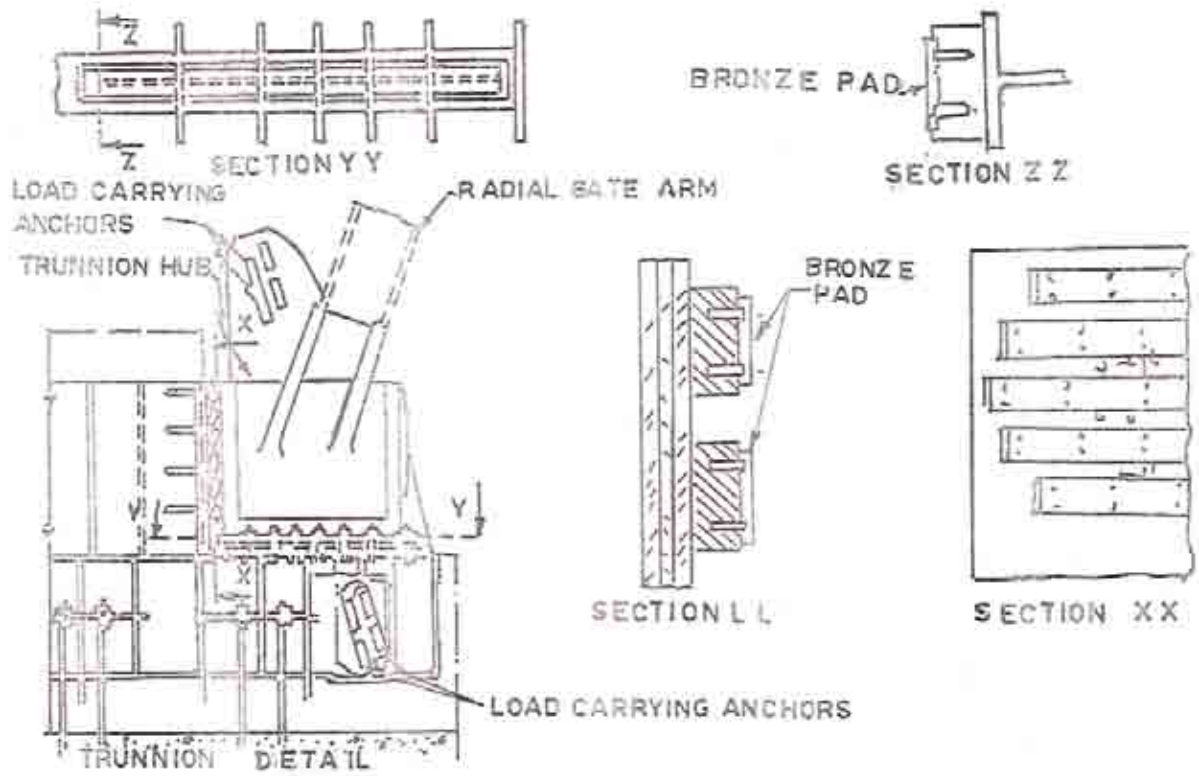
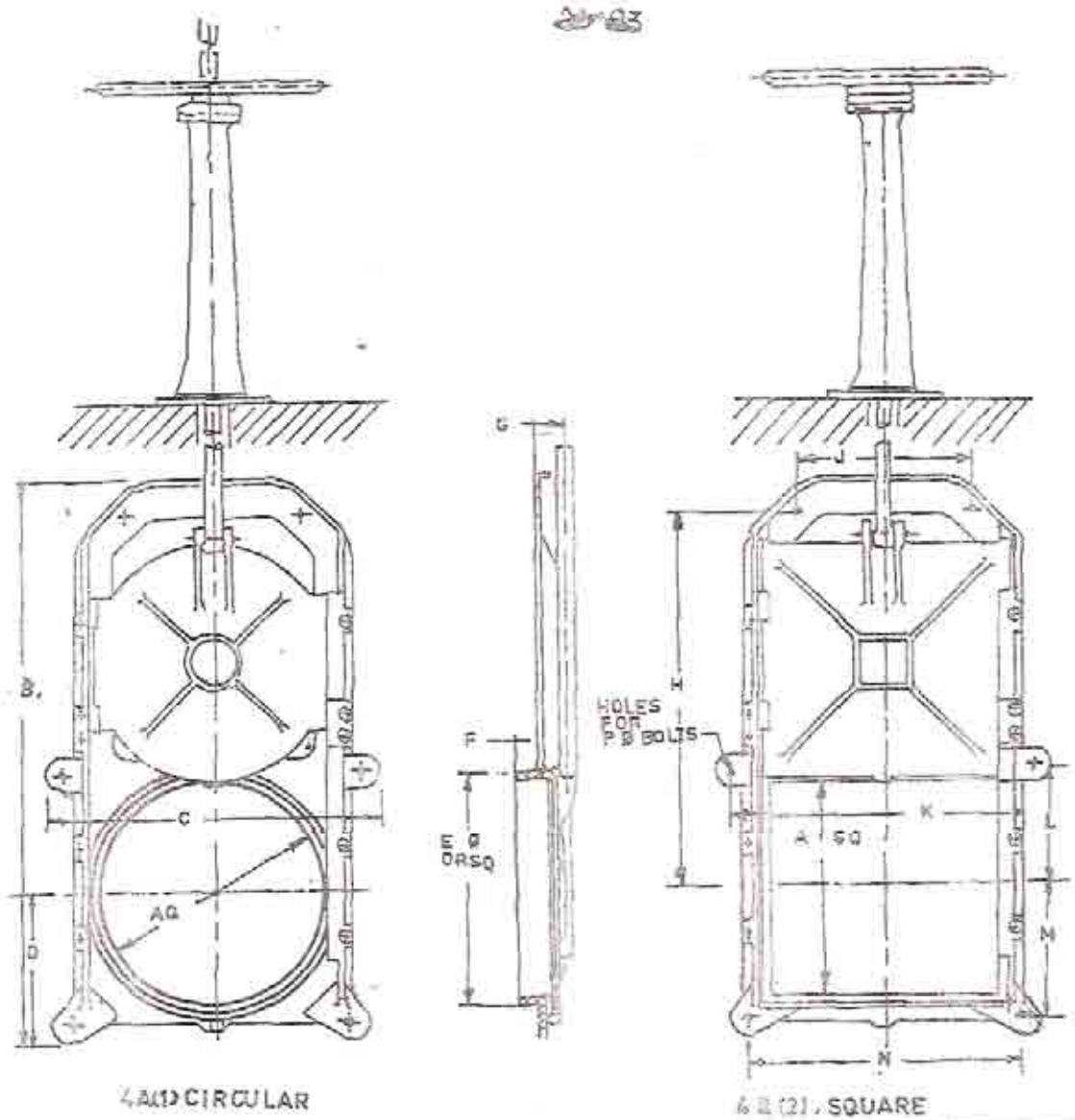

FIG. 3C. ARRANGEMENT FOR ALLOWING AND ELONGATION OF THE INSULATED LOAD CARRYING ANCHORS



4 AND CIRCULAR

6 2 (2), SQUARE

A	B	C	D	E	F	G	H	J	K	L	M	N	P
200	615	360	160	225	50	50	400	205	320	120	140	320	15
250	720	410	185	275	50	50	480	215	370	140	165	375	15
300	845	480	230	325	50	65	555	240	430	155	195	395	15
350	1010	555	275	365	65	75	600	275	530	195	245	495	20
450	1210	685	315	485	65	75	800	330	620	250	280	565	20
500	1350	755	350	535	65	80	895	380	685	280	310	630	20
550	1450	805	375	585	65	80	975	405	735	305	335	680	20
600	1550	875	400	640	65	80	1050	465	795	330	360	735	20

(All Dimensions in millimetres)  
 FIG 4A DIMENSIONS OF SINGLE FACED SLUICES 200mm X 600mm (RING TYPE)

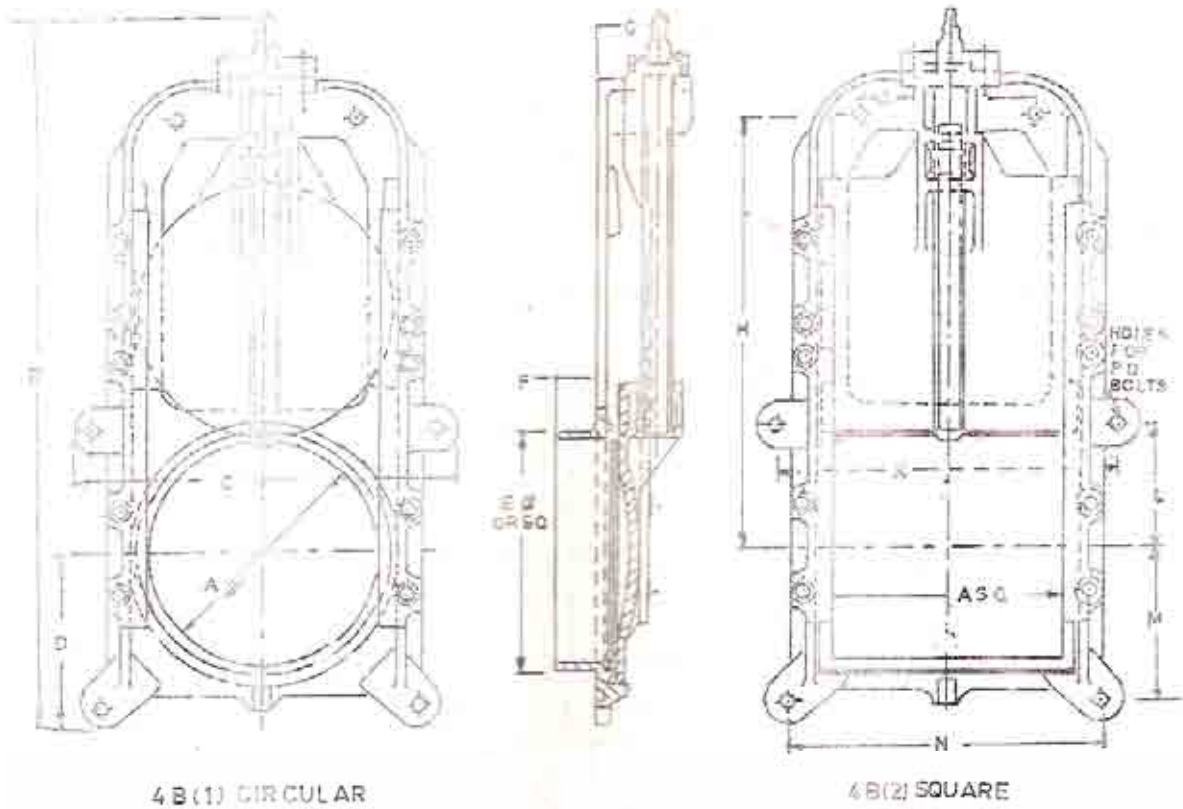

4B(1) CIRCULAR

4B(2) SQUARE

A	B	C	D	E	F	G	H	J	K	L	M	N	P
200	720	360	160	225	50	65	400	205	320	120	140	320	15
250	835	410	185	275	50	65	480	215	370	140	165	375	15
300	960	480	230	325	50	65	555	240	430	165	195	395	15
350	1120	595	275	385	65	80	680	275	530	195	245	495	20
450	1315	685	315	485	65	80	800	330	620	250	280	565	20
500	1475	755	350	535	65	100	895	380	685	260	310	630	20
550	1575	805	375	585	65	100	975	405	735	305	335	680	20
600	1675	975	400	640	65	105	1050	465	795	330	360	735	22

( All dimensions in millimetres )

FIG-4 B. DIMENSIONS OF SINGLE FACED SLUICES 200mm TO 600mm (NON RISING TYPE)

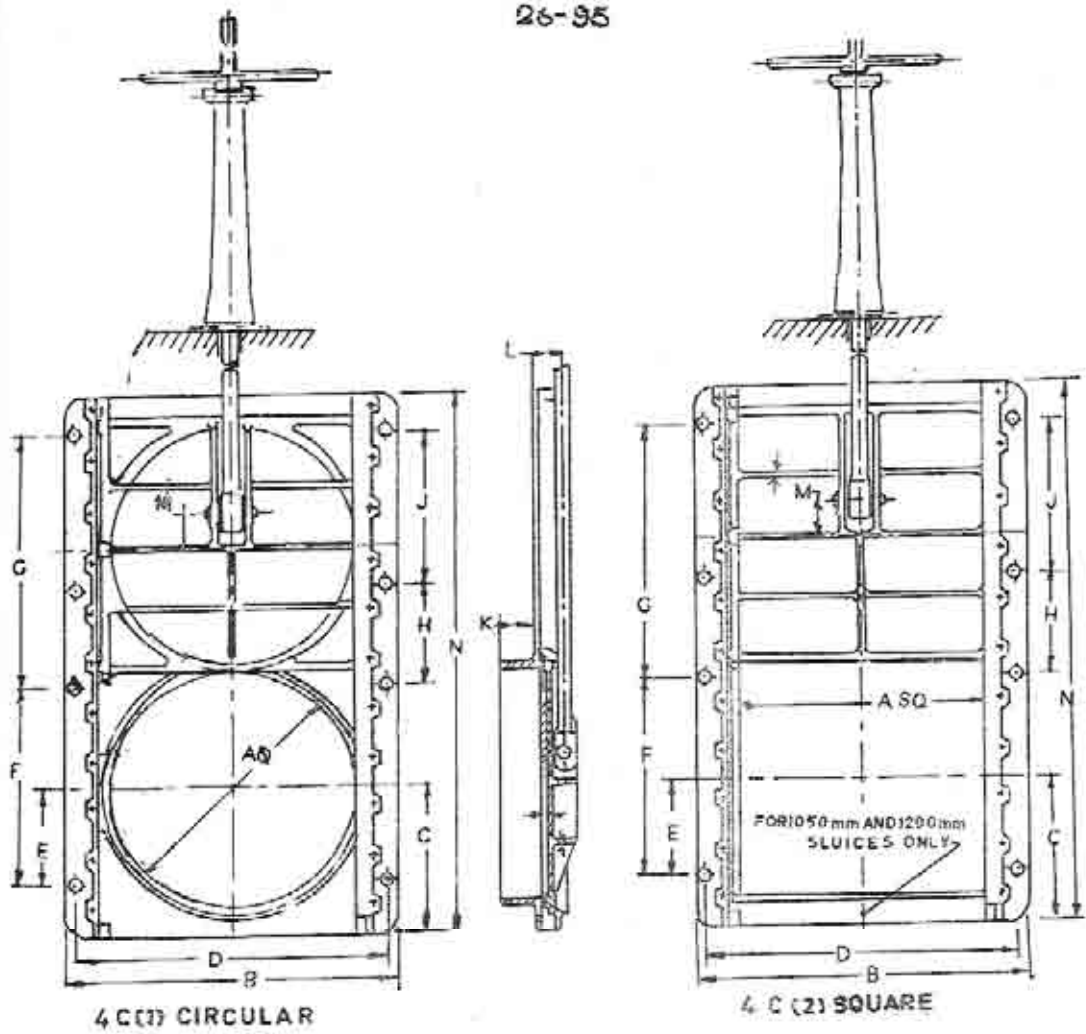

A	B	C	D	E	F	G	H	J	K	L	M	N	Binding Bolts	
													No.	dia.
200	465	215	415	70	420	—	—	—	85	95	—	700	4	20
250	465	215	415	70	420	—	—	—	85	95	—	700	4	20
300	515	240	465	85	475	—	—	—	85	95	—	800	4	20
450	710	325	660	145	380	380	—	—	85	95	—	1130	6	22
600	890	405	825	240	535	535	—	—	85	95	—	1445	6	24
750	1065	490	990	305	710	710	—	—	115	100	95	1765	6	24
825	1145	530	1065	345	710	890	—	—	115	105	115	1920	6	24
900	1220	565	1150	375	760	950	—	—	140	105	115	2070	6	24
1050	1370	675	1295	475	760	1330	570	760	150	115	—	2425	10	30
1200	1525	735	1445	535	915	1425	585	840	175	120	—	2715	10	30

(All dimensions in millimetres)  
**FIG 4 C DIMENSIONS OF SINGLE FACED SLUICES 200mm TO 1200 mm (RISING TYPE)**

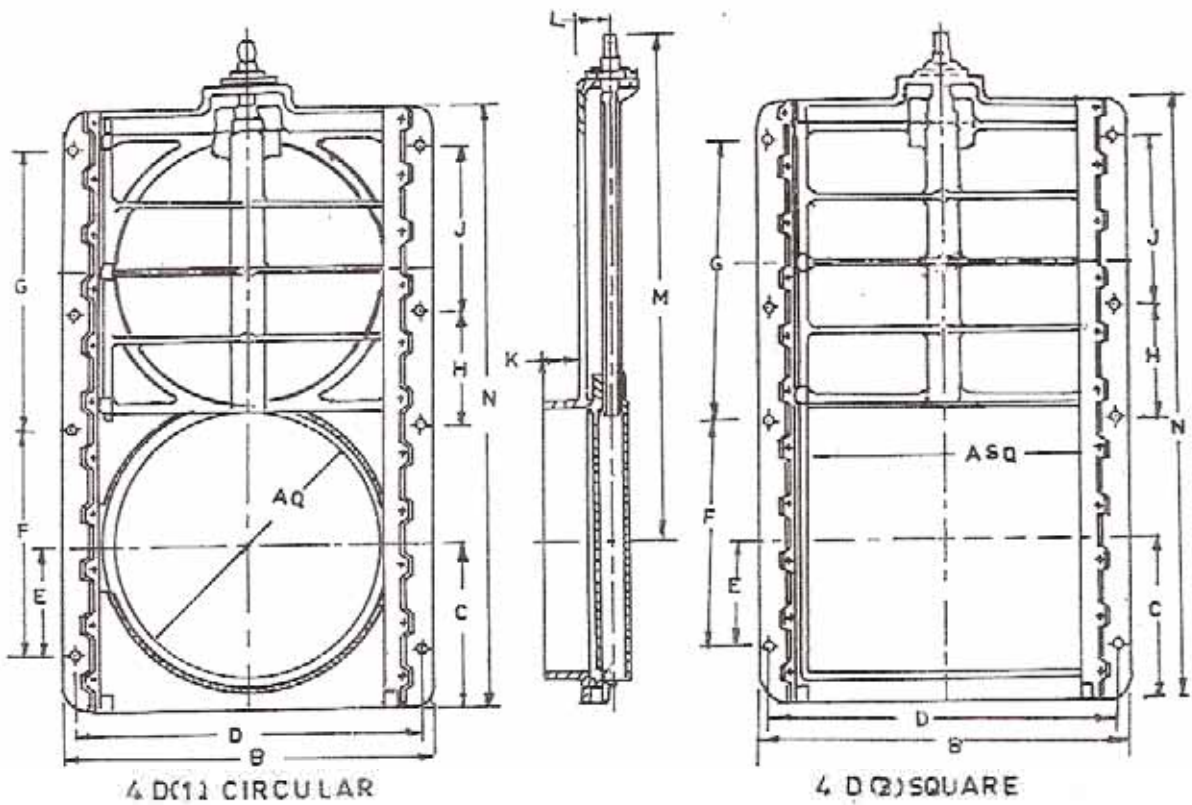

A	B	C	D	E	F	G	H	J	K	L	M	N	NO. BINDING BOLTS	DIA.
200	465	215	415	70	420	—	—	—	85	80	630	700	4	20
250	465	215	415	70	420	—	—	—	85	80	630	700	4	20
300	515	240	465	85	475	—	—	—	85	80	725	800	4	20
450	710	325	660	145	380	380	—	—	85	90	995	1130	6	22
600	890	405	825	240	535	535	—	—	85	100	1260	1445	6	24
750	1065	490	990	305	710	710	—	—	115	100	1470	1765	6	24
825	1145	530	1065	345	710	890	—	—	115	105	1615	1920	6	24
900	1220	565	1150	375	760	950	—	—	140	105	1735	2070	6	24
1050	1370	675	1295	475	760	1330	570	760	150	120	2055	2565	8	30
1200	1525	735	1445	535	915	1425	585	840	175	120	2310	2880	8	36

(All Dimensions in millimeters.)

FIG 4 D DIMENSIONS OF SINGLE FACED SLUICES 200mm TO 1200mm (NON BSING TYPE)

**CHAPTER 34 TO 39 ( DEALT AS CH.34)  
ELECTRICAL WORKS  
CONTENTS**

<b>Contents</b>	<b>Page No.</b>	
34.1	References	34-39-1
34.2	Terminology	34-39-3
34.3	General Requirements	34-39-9
34.3.1	Continuity with Indian Electricity Act. 191 0	34-39-9
34.3.2	Conventional Symbols	34-39-9
34.3.3	Materials	34-39-10
34.3.4	Execution of works	34-39-10
34.3.5	Safety Procedures	34-39-10
34.4	Electric Wiring Installation	34-39-10
34.4.1	General	34-39-10
34.4.2	Reception and Distribution of Main Supply	34-39-14
34.4.3	Fittings and Accessories	34-39-21
34.4.4	Methods of Internal Wiring	34-39-27
34.4.5	Specifications for bus bar chambers medium voltage installations	34-39-38
34.4.6	Earthing	34-39-42
34.4.7	Painting	34-39-48
34.4.8	Testing of installations	34-39-49
34.5	Overhead line work	34-39-52
34.6	Cable work	34-39-71
	Appendix -A	34-39-85
	Annexure XIII form of Reporting Electrical Accidents. Electric supply line, systems and Apparatus for low and medium voltages.	
	For high and extra high voltage- Testing, Operation and Maintenance metal sheathed electric supply lines connection with earth	
	General condition as to transformation and control from buildings of low and medium voltage lines	
	Appendix - B Architectural symbols for installation in buildings	34-39-134
	Appendix - C Safety procedures	34-39-137
	Appendix - D Form of completion certificate	34-39-149



**CHAPTER 34 TO 39 (DEALT AS CH. 34)  
ELECTRICAL WORKS**

**34.1 REFERENCES**

- IS: 347-1975 Varnish shellac, for general purpose (first revision)
- IS: 374-1979 Electrical ceiling type fans and regulators(Third Revision) (with Amendment No.1)
- IS: 375-1963 Marking and arrangement for switchgear busbars, main connections and auxiliary wiring (Revised with amendment No.1)
- IS: 1258-1979 Bayonet lamp holders (second revision) (with amendment No.1)
- IS: 1293-1967 Three pin plugs and sockets outlets (first revision) (with amendment No.1 to 5)
- IS: 2032-(pt II)-1962 Graphical symbols used in electro technology - Kind of current distribution systems and methods of connection (with ammendment no. 1 and 2 (Reaffirmed 1985)
- IS: 2032-(pt III)-1962 Graphical symbols used in electrotechnology - Circuit elements and variability.
- IS: 2032-(pt V)-1965 Graphical symbols used in electrotechnology - generating elements and variability.
- IS: 2032-(pt VI)-1965 Graphical symbols used in electrotechnology - motor starters (with Amendment No.1)
- IS: 2032-(pt VII)-1974 Graphical symbols used in electrotechnology - switchgear and auxiliaries (First revision)
- IS: 2032-(pt VIII)-1965 Graphical symbols used in electrotechnology - semiconductor devices (Reaffirmed - 1976)
- IS: 2032-(pt 26)-1982 Graphical symbols used in electrotechnology - Roating machines.
- IS: 2032-(pt 28)-1983 Graphical symbols used in electrotechnology - Transformer.

- IS : 2148-1981 Flame proof enclosures of electrical apparatus (2nd revision)
- IS : 2667-1976 Fittings for rigid steel conduits for electrical wiring (First Revision) (with Amendment No.1 and 2)
- IS : 3043-1966 Code of practice for earthing (with Amendment No.1 to 5)
- IS : 3419-1976 Fittings for rigid non - metallic conduits (First revision) (with Amendment No.1 and 2)
- IS : 3837-1976 Accessories for rigid steel conduits for electrical wiring (First revision)
- IS : 3854-1966 Switches for domestic and similar purpose (with Amendment No.1 to 6)
- IS : 4648-1968 Guide for electrical layout in residential buildings (with Amendment No.1)
- IS : 5133-1969 Steel and cast iron boxes (with Amendment No.1 and 2) (Part 1)
- IS : 5133-1969- Boxes made of insulating materials.  
(pt II)
- IS : 8270-1976- Guide for preparation of diagrams, charts and tables for  
(pt I) electrotechnology -Definitions and classifications.
- IS : 9537-1981- Conduits for electrical installations - rigid steel cenduits ( with  
(pt II) Amendment No.1)
- IS : 9537-1983- Conduits for electrical installation-Rigid plain conduits of insulating  
(pt III) materials.
- TamilNadu Building Practice-electrical Portion (Revised TNSS, 1983).
- National Building Code of India, 1983.
- IS : 5613(Part - - Code of practice for Design, Installation and Maintenance of  
I/Sec I)-1970 overhead power lines
- IS : 2713-1969 Specifications for tubular steel poles for overhead power lines.

IS : 731-1971	Specifications for porcelain insulators for overhead power lines with a nominal voltage greater than 1000V.
IS : 5613(Part -II/Sec 2)-1976	Code of practice for design insulation and maintenance of overhead power lines.
IS : 5613(Part -II/Sec I)-1976	Code of practice for design insulation and maintenance of overhead power lines.

### 34.2 TERMINOLOGY :-

**Accessory:** Any device associated with the wiring and electrical appliance of an installation, for example; a switch, a fuse, a plug, socket outlet, a lamp holder, or a ceiling rose.

**Apparatus:** Electrical apparatus including all machines appliances and fittings in which conductors are used or of which they form apart.

**Appliance:** An energy consuming device or equipment (other than a lamp) fixed or portable in which the electrical energy is converted into light, heat, motion or any other form of energy or substantially changed in its electrical character.

**Bunched:** Cables are said to be Bunched when two or more are contained within a single conduit duct or groove or, if not enclosed, are not separated from each other.

A length of single insulated conductor (solid or stranded) or two or more such conductors, each provided with its own insulation which are laid up together. The insulated conductor or conductors may or may not be provided with an overall mechanical protective covering.

**Cable armoured:** A cable provided with a wrapping or metal (usually in the form of tape or wire) serving as a mechanical protection.

**Cable Flexible:** A cable containing one or more cores, each formed of a group of wires, the diameters of the cores, and of the wires being sufficiently small to afford flexibility.

**Cable lead-covered:** A cable provided with a lead sheath for the purpose of excluding moisture from the conductors and insulation thereof such sheath consisting either of commercially pure lead or alternatively, of pure lead to which a small percentage of rarer metal has been added for hardening purposes.

**Cable, metal-sheathed:** An insulated cable with a metal sheath.

**Cable P.V.C. insulated or polythene insulated** - A cable in which the insulation of conductor or conductors in a polyvinyl - chloride compound or a polythene compound or a polythene compound .

**Cable P.V.C sheathed:** A cable in which mechanical protection is provided for the core or cores by a sheath of a polyvinyl - chloride compound.

**Cable, tough rubber-sheathed (Cable TRS):** An insulated cable consisting of one or more vulcanised insulated cores Surrounded by a close-fitting rubber sheath.

**Cable weather proof:** A cable so constructed that when installed in uncovered locations it will withstand all kinds of weather variations.

**Circuit:** An arrangement of conductor or conductors for the purpose of conveying energy and forming a system or a branch of a system

**Circuit Breaker:** A mechanical switching device, capable of making, carrying and breaking the circuit under normal circuit conditions and also making, carrying for specified time and breaking currents under specified abnormal circuit conditions such as those of short circuit.

**Circuit final sub.** : An outgoing circuit connected to one way distribution fuse board and intended to supply electrical energy at one or more points to current using appliances without the intervention of a further distribution fuse board other than one way board. It includes all branches and extensions derived Items that particular way in the board.

**Cleat:** An insulated incombustible support normally used for insulated cable.

**Conductor aerial-** Any conductor which is supported by insulators above the ground and is directly exposed to the weather.

Note - Four classes of Aerial conductors are recognised

- (a) Bare aerial conductors,
- (b) Covered aerial conductors,
- (c) Insulated aerial conductors, and
- (d) Weather proof neutral screened cable.

**Conductor bare:** A conductor not covered with insulating material.

**Conductor earthed:** A conductor with no provision for its insulation from earth.

**Conductor insulated:** A conductor adequately covered with insulating material of such quality and thickness as to prevent danger.

**Conductor of a cable or core:** The conducting portion consisting of a single wire or group of wires, assembled together and in contact with each other or connected in parallel.

**Conductor:** A mechanical clamp shrouded in insulating material for connecting the conductor of a cable or of a flexible cord to that of another flexible cord.

**Connector box or joint box:** A box forming a part of wiring installation, provided to contain joints in the conductors of cable of the installation.

**Connector for portable appliances:** A combination of a plug and socket arranged for attachment to a portable electrical appliance or to a flexible cord.

**Consumer's Terminals:** The ends of the electrical conductors situated upon any consumer premises and belonging to him at which the supply of energy is delivered from the service line.

**Cord, flexible:** A flexible cable having conductor of small cross-sectional area. Two flexible cords twisted together are known as twin 'flexible cord'.

**Core of a cable:** A single conductor of a cable with its insulation but not including any mechanical protective covering.

**Cut-out:** Any appliance for automatically interrupting the transmission of energy through any conductor when the current rises above a predetermined amount and shall also include fusible cut-out.

**Damp situation:** A situation in which moisture is either permanently present or intermittently present to such an extent as to be likely to impair the effectiveness and safety of the installation.

**Dead:** At or about potential and or disconnected from any live system.

**Direct earthing system:** A system of earth in which the parts of an installation are so earthed as specified but are not connected within the installation to the neutral conductor of the supply system or to earth through the trip coil of an earth leakage circuit-breaker.

**Distribution fuse-board:** An assemblage of parts including one or more fuses arranged for the distribution of electrical energy to final sub-circuits or to other distribution fuse-boards.

**Earth:** A connection to the general mass of earth by means of an earth electrode. An object is said to be 'earthed.' when it is electrically connected to an earth electrode; and a conductor is said to be 'Solidly earthed' when it is electrically connected to an earth electrode without a fuse, switch, circuit-breaker resistance or impedance in the earth connection.

**Earth Continuity Conductor :** The conductor, including any clamp, connecting the earthing lead or to each other those parts of an installation which are required to be earthed. It may be in whole or in part the metal conduit or the tenuity conductor of a cable or flexible cord incorporating such a conductor

**Earth electrode:** The final plate, pipe or other conductor electrically connected to the general mass of the earth.

**Earthing lead:** The final conductor by which the connection in the earth electrode is made.

**Earth leakage circuit-breaker system:** A system of earthing in which the parts of an installation, specified to be earthed, are so earthed through one or more earth leakage circuit - breakers or relays.

**Enclosed distribution board:** An enclosure containing bush-bars, with fuses for the purpose of protecting controlling or connecting more than one out going circuit fed from more than one or more incoming circuits.

**Exposed metal:** All metal parts of an installation which are easily accessible other than :

- (a) Parts separated from live parts by double insulation.
- (b) Metal Dame plates, screw heads, covers or plates, which are supported on or attached or connected to substantial nonconductive material only in such a manner that they do not become alive in the event of failure of insulation of live parts and whose means of fixing do not come in contact with any internal metal; and
- (c) Parts which are separated from live parts by other metal parts which are themselves earthed or have double insulation

**Fitting, lighting:** A device for supporting or containing a lamp or lamps together with any holder, shades, or reflectors, for example, a bracket, a pendant with ceiling rose, an elect roller, or a portable unit.

**Fuse:** A device that, by the fusion of one or more of its specially designed and proportioned components, opens circuits in which it inserts when the current through it exceeds a given value for a sufficient time. The fuse comprises all the parts that form the complete device.

**Inflammable:** A material capable of being easily ignited.

**Insulated:** Insulated shall mean separated from adjacent conducting material or protected from personal contact by a non-conducting substance or air space, in either case of offering permanently sufficient resistance to the passage of current or to disruptive discharge through or over the surface of the substance or space, to obviate danger or shock or injurious leakage of current.

**Installation (electrical)** - All the electrical wiring, accessories, fittings, consuming devices, control protective gear, and other apparatus associated with the wiring situated on any premises in which electricity is supplied or is to be supplied through any service connection.

**Insulation double:**

(a) *Of a conductor* - A conductor is said to have double insulation when insulating material intervenes not only between the conductor and its surrounding envelope (if a cable) or immediate support (if bare) but also between the envelope or support and earth.

(b) *Of an appliance:* An appliance having accessible metal parts doubly insulated when protective insulation is provided in addition to the normal functional insulation in order to protect against electric shock in case of break down of the functional insulation.

**Insulation (Electrical)** - Suitable non-conducting material, enclosing, surrounding or supporting a conductor.

**Live or alive:** Electrically charged so as to have a potential different from that of earth.

**Locations Industrial:** Locations where tools and machinery consuming large scale power load are installed. These include the industrial areas notified in the local supply regulations.

**Locations, non industrial:** Locations other than, industrial locations, and shall include residences, offices, shops show rooms, stores and similar premises where consumption is predominantly of lighting load. These include the areas notified as non-industrial in the local supply regulations.

**Multiple earthed neutral system:** A system of earthing in which the parts of an installation specified to be earthed are connected to the general mass of earth and in addition are connected within the installation to the neutral conductor of the supply system.

**Neutral or neutral conductor:** Includes the neutral conductor of a three-phase four wire system, the conductor of a single phase or DC installation which is earthed by the supply undertaking for otherwise at the source of the supply and the middle wire or common return conductor of a three-wire DC or single phase AC system.

**Point:** A point shall consist of the branch wiring from the branch distribution board, together with a switch as required as far as possible and including the ceiling rose of socket-outlet or suitable termination. A three pin socket-outlet point shall include, in addition, the connecting wire or cable from the earth pin to the earth stud of the branch distribution board.

**Plug:** A device carrying three metallic contacts in the form of pins intended for engagement with corresponding socket contacts and arranged for attachment to a flexible cord or cable.

**Service:** The conductors and equipment required for delivering energy from the electric supply system to the wiring system of the premises served.

**Socket-outer and plug:** A device consisting of two portions, for easily connecting portable lighting fittings and other current using appliances to the supply. The socket outlet is designed as a fixed member and the plug portion carries two or more metal contacts which connect with corresponding metal contacts in socket portion.

**Switch:** A manually operated device for closing and opening or for changing the connection of a circuit.

**Switch board:** An assemblage of switchgear with or without instruments but the term does not apply to a group of local switches on a final sub-circuit where each switch has its own insulating base .



**Switchgear:** Main switches, Cut-outs or fuses, conductors and other apparatus in connection there with, used for the purpose of controlling or protecting electrical circuits or machines or other current using appliances.

**Useable wall space:** All portions of a wall, except that occupied by a door, in its normal open position" or occupied by a fire place opening, but excluding wall spaces which are less than 1 m. in extent measured along the wall at the floor line.

**Voltage, low:** The voltage which does not normally exceed 250 volts (See Note under Voltage, High').

**Voltage, medium:** The voltage which normally exceeds 250 volts but does not exceed 650 volts (See Note under Voltage High),

**Voltage high:** The voltage which normally exceeds 650 volts. (See Note).

**Note-** The installation shall be so designed as to take into account the permissible variation in the declared supply voltage of 6 percent in respect of low voltage and medium voltage and + 6 per cent and - 9 per cent in respect of high voltage. .

**Weather proof:** Accessories, lighting fittings, current using appliances and cables are said to be of the weather proof type, if they are so constructed that when installed in open situation they will withstand the effect of rain, snow, dust and temperature variation.

### **34.3 GENERAL REQUIREMENTS:**

**34.3.1 Conformity with Indian Electricity Act 1910 and Rules made hereunder** - The installation shall generally be carried out in conformity with the requirements of the Indian Electricity Act. 1910 and the Indian Electricity Rules, 1956 framed there under and also the relevant regulations of the Electric Supply Authority concerned as amended from time to time. Extracts from the Indian Electricity Rules, 1956(a8 amended) referred to in this section are given in Appendix A

**34.3.2. Conventional Symbols:** The architectural symbols that are to be used in all drawings, wiring plans etc. for electrical installation in buildings shall be as given in Appendix - (B).

For other graphical symbols used in electric technology, reference may be made IS:2032 (Pt.II, III,& V to VIII,XXVI & XXVIII, IS:8270(Pt.I)).

**34.3.3 Materials:** All materials fittings, appliances etc. used in electrical installations, shall conform to the relevant Indian Standards.

**34.3.4 Execution of Works:** Unless otherwise exempted under the appropriate rule of the Indian Electricity Rules the work of electrical installations shall be carried out under the supervision of a person holding certificate of competency issued by recognized authority. The workman also shall hold a similar certificate of competency.

**34.3.5 Safety Procedures:** The safety procedures as given at Appendix- C shall be followed during execution and commissioning of the various electrical installations.

**34.4 ELECTRIC WIRING INSTALLATION:**

**34.4.1. General**

**34.4.1.1 *Layout of Wiring***

Installations with connected loads as under must be wired for the supply specified.

Less than 2000 watts	Single phase
More than 2000 watts	Three phases with the three circuits kept separate and maintained balanced as far as possible
Motors and apparatus requiring more than 1. 5HP	Each shall be wired for 400 volts 3 phase supply.

**34.4.1.1.2** The wiring shall be carried out as may be specified in the Tender schedule, or specified in the special specification. 'Power' and 'Heating' wiring shall be kept separate and distinct from Lighting and Fan Wiring.

All wiring shall be done on the distribution system with main and branch distribution boards at convenient physical and electric & centers and without fuses at isolated places. All conductors shall run, as far as possible, along the walls and ceiling so as to be easily accessible and capable of being thoroughly inspected. In no case open wiring shall be run above false ceiling without the approval of Engineer in charge. The concealed wiring when run along the walls should be as near the ceiling as possible. In all types of wiring due consideration shall be given for neatness, good appearance and safety.

**34.4.1.1.3** The balancing of circuits in three wire or poly phase installations shall be arranged before hand to the satisfaction of the Engineer in Charge. Circuits on opposite pole of a three wire D.C. system or in different phases of a poly phase system shall be kept apart at a minimum distance of 2 metres unless, they are enclosed in earthed metal casing suitably marked to indicate the risk of dangerous shock due to the voltage between the conductors contained in them. In large or important rooms, light and socket cutlet points shall be distributed over more than one circuit, as directed by the Engineer in charge.

**34.4.1.1.4** Medium pressure wiring and associated apparatus shall comply in all respect, with the requirements of rules 50,51 and 61 of IE rules 1956 as amended. (See Appendix'A').

**34.4.1.1.5** All current consuming devices shall be suitable for the pressure and frequency of the supply to which these are to be connected.

**34.4.1.2 Drawings:** All wiring diagrams for new buildings shall indicate clearly in plan, the main switch board, the distribution fuse board, the run of various mains and sub - mains and the position of all points with their classification and their controls. All circuits shall be indicated and numbered in the wiring diagram and an points shall be given the same number as the circuits to which they are electrically connected. Distribution boards shall also be marked to indicate the circuit numbers controlled by them.

**34.4.1.3 Cables:**

**34.4.1.3.1** All cables shall conform to relevant Indian Standards.

**34.4.1.3.2** The smallest aluminum conductor for the final circuit shall have a nominal cross sectional area of net less than 1.5 square mm. (1/1.40 mm). The minimum of aluminum conductor for power wiring -shall be 4 square mm. (1/2.24 mm).

**34.4.1.4 Flexible cables:**

**34.4.1.4.1** Conductor of flexible cable shall be of copper; the current rating for flexible cables are given in Table 1. The minimum cross sectional area of conductor for flexible cable shall be .004 sq cm 14/0.193 mm.

**34.4.1.4.2** Unless the flexible cables and conduits are protected by armour or tough rubber or PVC sheath they shall not be used in workshops and other places where they are liable to mechanical damage.

**34.4.1.4.3** Three core flexible cables shall be used for connecting single phase appliances. Current rating is given in Table 2.

**34.4.1.5** *Rating of lamps, fans, socket outlet points and Exhaust fans:*

**34.4.1.5.1** Incandescent lamps in residential and non residential buildings shall be rated at 60 watts and 100 watts respectively.

**34.4.1.5.2** Table fans and ceiling fans shall be rated at 60 watts. Exhaust fans shall be rated according to their capacity.

**34.4.1.5.3** Five amps socket outlet points and 15 amps socket outlet points shall be rated at 100 watts and 1,000 watts respectively, unless the actual values of load are known or specified.

**34.4.1.6** *Joints and Looping back :*

**34.4.1.6.1** where the looping back system of ,wiring is specified the wiring shall be done without any junction or connection boxes on the line. Where the joint box system is specified, all joints in conductor shall be made by means of approved, mechanical connection in suitable and approved joint boxes. In non residential buildings, neutral conductor and Earth continuity wire shall be brought to each switch board situated in rooms and halls. These shall be terminated inside the swich boards with suitable connector and the Switch board shall be of adequate size to accommodate one number 5 amps socket outlet and control switch in future.

These items shall be listed separat81y in the schedule of work and paid accordingly.

**34.4.1.6.2** In any system of wiring, looping back or joints box system, no bare or twist joints shall be made. In through run of cables, if the length of the final circuit sub - main is more than the length the standard coil, joints shall be made be means of approved mechanical connection only in suitable and approved junction boxes.

**34.4.1.7** *Connection to Ancillary building :*

**34.4.1.7.1** Unless otherwise specified, electrical connections to ancillary buildings, such as out-houses, garages etc, adjust to the main building at a distance not greater than 3m and where no road intervenses shall be taken in an earthed GI. pipe of suitable size in the exposed portion at a height of not less than 2.5 m or by UG cables. This applies to both runs of mains or sub - mains or final sub circuit wirings between the buildings.

**34.4.1.7.2** When the distance between the buildings exceeds 3m or a road way intervenes, separate mains or sub-mains shall be run from the main building to ancillary building and the portion of the same exposed to weather shall be carried in weather proof cable on G.I. bearer wire a height not less than 4m above the ground. Alternatively PVC wire enclosed in G.I pipe or Underground cable may be used below ground level.

**34.4.1.7.3** When a roadway intervenes the portion of any U.G. cable in the road crossing shall be enclosed in stone ware pipes.

**34.4.1.8 Structural Alteration to Buildings :**

No alteration which shall affect the structure of building shall be done unless sanction of the competent authority has first been obtained.

**34.4.1.9 Commissioning tin Completion :**

Before the workman levels the work finally, he must make sure that the installation is in commission.

**34.4.1.10 Provision for Maximum load :**

All conductors, switches and accessories shall be of such size as to be capable of carrying without their respective ratings being exceeded the maximum current which will normally flow through them.

**34.4.1.11 Addition to an Installation :**

An addition temporary or permanent shall not be made to the authorised load of an existing installation until it has been definitely ascertained that the current carrying capacity and the condition of the existing accessories, conductors, switches etc. affected including those of the Supply Authorities are adequate for the increased load.

**34.4.1.12 Design and Construction ::**

All materials supplied shall be new and conforming to relevant Indian Standard Specifications wherever they exist. Materials having I.S.I. certification marks will be preferred.

**Special Risks :** Special forms of construction such as flame proof enclosures shall be adopted where there is risk of fire or explosion and wherever indicated in the specification.

**34.4.2** Reception and Distribution of Main Supply:

**34.4.2.1** Control at point of entry of supply:

**34.4.2.1.1** There shall be linked main switchgear with fuse or circuit breaker on each live conductor of the supply mains at the point of entry. The wiring throughout the installation shall be such that there is no break in the neutral wire except in the form of a linked switchgear. The neutral shall also be distinctly marked. In this connection rule 32 (2) of the Indian Electricity Rules, 1956 (See Appendix A) shall be referred.

**34.4.2.1.2** The main switchgear shall be situated as near as practicable to the termination of service line and shall be easily accessible without the use of any external aid.

**34.4.2.1.3** On the main switchgear, where the conductor include an earthed conductor of a two wire system or an earthed neutral conductor of a multi-wire system or a conductor which is to be connected there to an indication of a permanent nature shall be provided to identify the earthed neutral conductor. In this connection rule 32 (1) of the Indian Electricity Rules, 1956 (See Appendix A) shall also be referred.

**34.4.2.2** Main switchgears, switch board and their location:

**34.4.2.2.1** All main switches or miniature circuit breakers shall be either of metal clad enclosed patterns or of any insulated enclosed pattern which shall be fixed at close proximity to the point of entry of supply.

**34.4.2.2.2 Location:**

(a) Open type switch boards shall be placed only in dry situation and in well ventilated rooms and they shall not be placed in the vicinity of storage batteries and exposed to chemical fumes.

(b) In a damp situation or where inflammable or explosive dust, vapor or gas is likely to be present, the switch boards shall be totally enclosed or made flame proof as may be necessitated by the particular circumstances.

- (c) In case of switch board, if unavoidably fixed in places likely to be exposed to weather, to drip or to abnormal moist atmosphere, the outer casing shall be weather proof and shall be provided with glands or bushings or adopted to receive screwed conduit according to the matter in which cables are run.
  - (d) A switch board shall not be installed so that its bottom is within 1.25 m, above the floor, unless the front of the switch board is completely enclosed by a door" or the switch board is located in a position to which only authorised persons have access.
- 34.4.2.2.3** Switch boards shall be recessed in the wall if so specified in the schedule of work or in the special specification. The front shall be fitted with hinged panel of wood or other suitable material as hard board in wood frame with locking arrangement, the outer surface of door being flush with walls. Ample room shall be provided at the back for connections and at the front between the switchgear mountings and the door.
- 34.4.2.2.4** Equipments which on the front of a switch board shall be so arranged that inadvertent personal contact with live part is unlikely during the manipulation of switchgears ,changing of fuses or Jake operations.
- 34.4.2.2.5** No holes other than the holes by means of which the panel is fixed shall be drilled closer than 1.3cms from any edge of the panel.
- 34.4.2.2.6** The various live part unless they are effectively screened by substantial barriers of non-hydroscopic, non inflammable insulating material, shall be so spaced that an arc cannot be maintained -between such parts and earth.
- 34.4.2.2.7** The arrangement of the gear shall be such that they shall be readily accessible and their connections to all instruments and apparatus shall also be traceable.
- 34.4.2.2.8** In every case in which switches and fuses are fitted on the same pole, these fuses shall be so arranged that the fuses are not alive when their respective switches are in the off position.
- 34.4.2.2.9** No fuses other than fuses in instrument circuit shall be fixed on the back of or behind a switch board panel or frame.
- 34.4.2.2.10** An the metal switchgears and switch boards shall be painted ,prior to erection, with one coat of anti rust primer. After erection, they shall be painted with two coats of approved enamel or aluminum paint as required on all sides wherever accessible.

**34.4.2:2.11** All switch boards connected to medium voltage and above shall be provided with Danger Notice Plate conforming to relevant Indian Standards.

**34.4.2.3** *Types of Switch Boards:*

**34.4.2.3.1** Metal clad switchgear shall preferably be mounted on any of the following types of boards.

**(a) Hinged type Metal Boards :** These are particularly suitable for small switch board for mounting metal clad switchgear connected to supply at low voltage (230 volts).

Such boards shall be suitable for mounting of metal clad switchgear consisting of not more than one Iron clad switch and ICDB 4 way or 6 way 15 amps per way.

These shall consist of a box made of sheet metal not less than 2 mm thick and shall be provided with a hinged cover to enable the board to swing open for examination of the wiring at the back. The joints shall be welded. A teak wood board thoroughly protected both inside and outside with good insulating varnish conforming to IS:347-1975 and not less than 6.5 mm thickness shall be provided at the back for attachment of incoming and outgoing cables. There shall be a clear distance of not less than 2.5 cm, between the Teakwood board and the cover, the distance being increased for larger boards in order that on closing of the cover the insulation of the cable is not subjected to ' damage and no short length of cable is subjected to excessive twisting or bending in any case. The board shall be securely fixed to the wall by means of rag bolts, plugs or wooden gutties and shall be, provided with a locking arrangement and an earthing stud.

The earth stud should commensurate with the size of the earth lead/leads. All wires passing through the metal boards shall be made with insulating bushes.

No apparatus shall project beyond any edge of the panel. No fuse body shall be mounted within 2.5 cm of any edge of the panel.

**(b) Fixed type metal boards:** Such boards shall be suitable for large switch boards for mounting large number of switchgears and/or higher capacity metal clad switch gear or both.

These shall consist of an angle or channel iron frame fixed on the wall or on the floor and supported on the wall at the top. There shall be a clear distance of 1m in front of the switch board. If there are any attachments or bare connections at



the back of the switch board Rule 51(1) of Indian Electricity Rules (See Appendix A) shall apply.

The connections between the switchgear mounting and the outgoing cable up to the wall shall be enclosed in a protection pipe.

**34.4.2.3.2 Teak Wood Boards:** For small installations connected to a single phase 240 volts supply, teak wood boards, may be used as main.-boards. These shall be of seasoned teak or other durable wood with solid back impregnated with varnish of approved quality with all joints dovetailed.

**34.4.2.4 Dimensions:**

The detailed dimensions and design of metal boards/Teak wood boards and angle iron frame work for switchgears including the disposition of the various mountings which shall be symmetrically and neatly arranged for arriving at the overall dimensions shall be prepared and submitted before hand and shall have the prior approval of the Engineer-in-charge. This will apply to large medium voltage installations.

**34.4.2.5 Marking of Apparatus:**

**34.4.2.5.1** When a board is connected to voltage higher than 250 volts, all the terminals or leads of the apparatus mounted on it shall be marked in the following colours to indicate the different poles or phases to which the apparatus or its different terminals may have been connected.

Three phases	-	Red, Blue and Yellow
Neutral	-	Black
D.C.		
Three wire system		
Two outer wire	-	Red and Blue
Neutral	-	Black

Where four wire three phase wiring is done the neutral shall preferably be in one colour and the other three wires in another colour.

**34.4.2.5.2** Where a board has more than one switch each such switch shall be marked to indicate which section of the installation it controls. The main. switch shall be marked as such. Where there is more than one main switch in the building each such switch shall be marked to indicate which section of the installation and building it controls.

**34.4.2.5.3** All marking required under this rule shall be clear and permanent.

**34.4.2.5.4** All distribution boards shall be marked 'lighting' or 'Power as the case may be and also marked with the pressure and number of phases of the supply. Each shall be provided with a circuit list giving details of each circuit which it controls and the current rating of the circuit and size of the fuse element.

**34.4.2.6 Main and Branch Distribution Boards:**

**34.4.2.6.1** Main and branch distribution boards shall be of any type mentioned in 34.4.2.3

**34.4.2.6.2** Main distribution boards shall be provided with a switch or circuit-breaker on each pole of each circuit, on a fuse on the phase or live conductor and a link on the neutral or earthed conductor of each circuit. The switches shall always be linked.

**34.4.2.6.3 Branch Distribution Boards :**

**34.4.2.6.3.1** Branch distribution boards shall be provided with a fuse or miniature circuit breaker or both of adequate rating/setting on the live conductor of each circuit and the earthed neutral conductor shall be connected to a common link and be capable of being disconnected individually for testing purposes. At least one spare circuit of the same capacity shall be provided on each branch distribution board.

**34.4.2.6.3.2** In residential and office installations lights and fans may be wired on a common circuit. Such sub circuit shall not have more than a total of ten points of lights, fans and socket outlets. The load of such circuit shall be restricted to 800 watts. If a separate fan circuit is provided, the number of fans in the circuit shall not exceed ten. Power circuits shall be designed according to the load but in no case shall there be more than two outlets on each sub-circuit.

**34.4.2.7 Installation of Distribution Boards:**

**34.4.2.7.1** The distribution fuse boards shall be located as near as possible to the centre of the load they are intended to control

**34.4.2.7.2** These shall be fixed on suitable stanchion or wall and shall be accessible for replacement of fuses.

**34.4.2.7.3** These shall be either metal clad type or all insulated type. But, if exposed to weather or damp situations they shall be totally enclosed in accordance with IS 2148-1981.

**34.4.2.7.4** Where apparatus is to be operated at medium voltage or where medium voltage exists between two or more adjacent low voltage circuits terminals or other fixed live parts not permanently shrouded in insulating material shall either be installed so as to be accessible only to authorised personnel or shall be enclosed in earthed metal or non-combustible insulating material and the distribution boards shall be fixed not less than 2 m apart.

**34.4.2.7.5** All circuits shall be marked distinctly on distribution boards as 'lighting' or 'power' as the case may be, and also marked with the voltage and number of phases of the supply. Each board shall be provided with a circuit list giving details of each circuit which it controls and the current rating of the circuits and size of fuse element.

**34.4.2.8 Wiring of Distribution Boards:**

**34.4.2.8.1** In wiring a branch distribution board, the total load of the consuming devices shall be divided as far as possible evenly between the number of ways of the board leaving the spare circuit for future extension.

**34.4.2.8.2** All connections between pieces of apparatus or between apparatus and terminals on a board shall be neatly arranged in a definite sequence following the arrangement of the apparatus mounted thereon, avoiding unnecessary crossings.

**34.4.2.8.3** Cables shall be connected to terminals only by soldered or welded lugs, unless the terminals are of such a form that they can be securely clamped without cutting away of cable strands. Aluminum conductors should be tinned before insertion to clamps.

**34.4.2.8.4** All bare conductors shall be rigidly fixed in such a manner that a clearance of at least 2.5 cm is maintained between conductors of opposite polarity or phase and between the conductors and any material other than insulating material.

**34.4.2.8.5** In a hinged board the incoming and outgoing cables shall be neatly bunched and shall be fixed in such a way that the door shall be capable of swinging through an angle of not less than 90 degrees.

**34.4.2.8.6** If required in the Special Specification, a pilot lamp shall be fixed and connected through an independent single pole switch and fuse to the bus bars of the board.

**34.4.2.9 Fuses:**

**34.4.2.9.1** A fuse carrier shall not be fitted with a fuse element larger than that for which the carrier is designed.

**34.4.2.9.2** The current rating of a fuse shall not exceed the current rating of the smallest cable in the circuit protected by fuse (Table 3).

**34.4.2.9.3** For the connected load exceeding 100 amps cartridge or HRC fuses shall be used.

**34.4.2.9.4** Every fuse shall have its own case or cover, or in an adjacent conspicuous position, an indelible indication of its appropriate current rating for the protection of the circuit which it controls.

**34.4.2.10 *Passing through walls and floors :***

**34.4.2.10.1** When conductors pass through walls, any one of the following methods shall be employed. Care shall be taken to see that wires pass very freely through protective pipe or box and that wires pass through in a straight line without any twist or cross in wires, on either ends of such holes.

**34.4.2.10.1.1** A box of teak wood or approved hard wood extending through the whole thickness of the wall shall be buried in the wall and casings or conductors shall be carried so as to allow 1.3 cm air space on the three sides of the casing or conductor.

**34.4.2.10.1.2** The conductors shall be carried in an approved heavy gauge solid drawn or lap welded conduit conforming to IS:9537 Part II 1981 & IS:9537 Pt.III-1983 or in a porcelain tube of such size that it permits easy drawing in. The ends of conduit shall be neatly bushed with porcelain, wood or other approved material

**34.4.2.10.2** Insulated conductors while passing through floors shall be protected from mechanical injury by means of steel conduit (as per IS:9537 Pt.III1981 and IS:9537 Pt.III1983) to a height of not less than 1.5 metre above the floors and flush with the ceiling below. This steel conduit shall be earthed and securely bushed.

**34.4.2.10.3** Where a wall tube passes outside a building so as to be exposed to weather, the outer end shall be bell mouthed and turned downwards and properly bushed on the open end.

**34.4.2.11 *Wiring to walls and ceilings :***

**34.4.2.11.1** Plug for ordinary walls or ceiling shall be of well seasoned teak or other approved hard wood not less than 5 cm long by 2.5 cm square on the inner end and 2 cm. square on the outer end. They shall be cemented into walls within 6.5mm, of the surface, the remainder being finished according to the nature of the surface with plaster or lime putting.

**34.4.2.11.2** Where owing to irregular coursing or other reasons the plugging of the walls or ceiling with wood plugs present difficulties, the wood batten or metal conduit shall be attached to the wall or ceiling in an approved manner. In the case of new buildings, the teak wood plugs shall be fixed in the walls, as far as possible, before first coat of white washing.

**34.4.2.11.3** Plugging of walls or ceiling can be done in a better way where neatness is the first consideration. In all such cases an approved type of asbestos or fibre fixing plug (Rawl or Phil plug) with correct size of tools shall be used and done in a workman like manner.

### **34.4.3 Fittings And Accessories:**

#### **34.4.3.1 Lighting fittings:**

**34.4.3.1.1** Where conductors are required to be drawn through tube or channel leading to the fitting, the tube or channel must be free from sharp angles or projecting edge and of such size as will enable them to be wired with the conductors used for the final circuit without removing the braiding or tapping. As far as possible all tubes or channels should be of sufficient size to permit of looping back. Non-current carrying metal parts of each lighting fitting should be bonded to an earth continuity conductor.

#### **34.4.3.1.2 Use of flexible cords:**

(a). Where a light fitting is supported by one or more flexible cords, the maximum weight to which the twin flexible cords can be subjected shall be as follows :

#### **Size of twin flexible cords**

Nominated cross sectional area (sq. inches)	Number and diameter of wires in		Maximum permissible weight in.	
	Inches	mm	Kg.	Lbs
1	2	3	4	5
0.4 (0.0006)	14/0.0076	14/0.193	1.4	3
0.7(0.0010)	23/0.0076	23/0.193	2.3	5
1.25(0.0017)	40/0.0076	40/0.193	4.5	10

Where a weight greater than 4.5 kg has to be supported, other means of support namely, suitable metal pipe or suitable chain shall be provided. (details are given in table 4)

(b) Care shall be taken that any hooks or clips, used as supports for a flexible cord, do not damage the insulation.

(c) Where it is necessary for a flexible cord to pass through or be installed above a false ceiling, the flexible cord shall be of the tough rubber or PVC sheathed type (if desired with reduced thickness of insulation) and the mode of installation shall obviate risk of mechanical damage.

**34.4.3.1.3** No inflammable shade shall form a part of a light fitting unless such shade is well protected against all risks of fire. Celluloid shade or light fittings shall not be used under any circumstances. Vitreous enameled iron shade shall be of size 250 mm x 90 mm (nominal size with a tolerance of 5 mm). Plastic shade shall not be generally used in the fittings suitable for incandescent lamps.

**34.4.3.1.4** Enclosed type fittings shall be provided with a removable glass receptacle, arranged to enclose the lamp completely and of such size or construction as to prevent undue heating of the lamp, or if the position of fittings be such that the glass receptacle is liable to mechanical damage, the glass shall be protected by a suitable wire guard.

**34.4.3.1.5** The leads of pre wired fixture shall be terminated on ceiling rose or connector.

**34.4.3.2** *Outdoor Fittings:*

**34.4.3.2.1** External and road lamps shall have weather proof fittings of approved design so as to effectively prevent the admission of moisture. An insulating distance piece of moisture proof material shall be inserted between the lamp holder, nipple and the fitting. Flexible cord conductors and cord grip lamp holders must not be used where exposed to weather.

In verandahs and similar exposed situations where pendants are used, they shall be of fixed rod type.

**34.4.3.3** *Bulk Head Fittings:*

Bulk head fitting shall be of cast iron/ cast aluminum body suitably painted white inside and grey outside complete with heat resistant glass cover, B.C. holder and wire guard suitable for 100 watts incandescent lamp. Where specified gasket for glass cover and shock proof B.C. holder shall be provided.

**34.4.3.4 Accessories:**

**34.4.3.4.1** Switches: All switches shall be placed in the live conductor of the circuit and no single pole switch or fuse shall be inserted in the earth or earthed neutral conductor of the circuit. Single pole switches (other than for multiple control) carrying not more than 15 amperes may be of the tumbler type and the switch shall be "on" when the handle or knob is down.

**34.4.3.4.2** *Lamp holders:* Lamp holders for use on brackets shall be in accordance with IS:1258-1979 and all those for use with flexible pendant shall be provided with cord grips. All lamp holders shall be provided with shade carriers. Where center contact Edison Screw lamp holders are used, the outer or screw contact shall be connected to the "middle wire" or the neutral or to the earthed conductor of the circuit.

**34.4.3.4.3** *Lamps:* All incandescent lamps unless otherwise required shall be hung at height of 2.5m above the floor level

**34.4.3.4.4** They shall be provided with caps of the following patterns.

Up to and including 200 watts	Standard Bayonet (D)
Above 200 watts and not exceeding 300 watts	Edison screw (E. S.)
Above 500 watts	Golliath screw(G.S.)

**34.4.3.4.5** *Ceiling Rose:* (a) A ceiling rose or any other similar attachment shall not be used on a circuit, the voltage of which normally exceeds 250 volts.

(b) Normally only one flexible cord shall be attached to a ceiling rose, specially designed ceiling roses shall be used for multiple pendants.

(c) A ceiling rose shall not embody fuse terminal as an integral part of it.

**34.4.3.4.6** *Socket Outlets:* (a) A socket outlet shall not embody fuse terminal as integral part of it. But the fuse may be embodied in plug in which case plug shall be non-reversible and shall be so arranged and connected that the fuse is connected to phase/live conductor or the non-earthed conductor of the circuit.

(b) Every socket outlet shall be controlled by a switch.

(c) The switch controlling the socket outlet shall be on the 'live' side of the line.

## 26-120

(d) 5 amps and 15 amps socket outlet shall normally be fixed at any convenient place 23 cm above the floor level or near the switch level as desired by the Engineer-in-charge. The switch for 5 amps socket outlet shall be kept at normal switch level and that for 15 amps along with the socket outlet.

15 amps socket outlet in the kitchen of the residential buildings shall be fixed at convenient place 23 cm above working platforms.

In a room containing a fixed bath or shower, there shall be no socket outlet and there shall be no provision for connecting a portable appliance. Any stationery appliance connected permanently in the bath room shall be controlled by an isolator switch or circuit breaker.

(e) Where socket outlets are placed at lower level, they shall be enclosed in a suitable wooden or metallic box, as the case may be, to harmonise with the system of wiring adopted.

(f) In an earthed system of supply, a socket outlet and plug shall be of the three pin type, the third terminal shall be connected to earth.

(g) Conductors connecting electrical appliance with socket outlet shall be of flexible twin cord with an earthing cord which shall be secured by connecting between the earth terminal of plug and the metallic body of the electrical appliance.

(h) Where use of shutter type or interlocking type of socket is required for any special installation, the items should be separately and specifically listed in the Schedule and Specification of that particular work.

**34.4.3.4.7** Call-bell / buzzer wiring: Call bell/buzzer Wiring shall not be done by twin flex plastic insulated wire. It shall be done by the usual point wiring adopted for other accessories. If however use of flexible cable is unavoidable, it shall be PVC sheathed cable. Where the flexible cable is liable to mechanical damage, the same shall be suitably protected by PVC sleeve or conduit.

**34.4.3.5** Attachment of fittings and accessories:

**34.4.3.5.1** In wood batten wiring, accessories like ceiling roses, brackets, battens, staff pendants etc. shall be mounted to ceiling or wall on substantial blocks of teak wood or approved hard wood double board construction twice varnished both inside and outside including back side after all fixing holes are made in them Blocks shall not be less than 4cm deep.



**34.4.3.5.2** In wood batten wiring, accessories like switches socket outlets, call bell pushes etc. shall be flush mounted inside substantial box or block of teak wood or approved hard wood double board construction twice varnished both inside and outside including back side after all fixing holes are made in them and attached to the wall. Blocks shall not be less than 4 cm deep. The cover for the box or block shall be of either asbestos cement tile or phenolic laminated sheet as approved by the Engineer-in-charge.

**34.4.3.5.3** In wood batten wiring, groups of accessories and regulators shall be mounted on well seasoned and properly secured double teak wood or approved hard wood boards of suitable size to accommodate the number of fittings. The board shall be well varnished with pure shellac on all sides, both inside and outside, irrespective of being painted to match the surroundings. The board shall be divided into two sections, one for the switches which shall be flush mounted and the other for regulators fixed on the board with suitable flat washers and round head iron screws (or any other type of screw as required). The cover for section accommodating switches and socket outlets shall be of either asbestos cement sheet or phenolic laminated sheet fixed with aluminum alloy/brass/cadmium plated iron screws as approved by the Engineer-in-charge. Wherever possible the control boxes shall be recessed in case of wood batten wiring and in such cases metal boxes conforming to para 34.4.4.3.1.9 shall be used. The metal boxes shall be suitably earthed.

**34.4.3.5.4** Alternatively in the case of wood batten wiring, switches may be surface mounted on teak wood or approved hard wood boxes. But in this case, the rate shall be suitably reduced and amended items may be entered in the Schedule of work.

**34.4.3.5.5** In case of conduit wiring, all accessories like switches, socket outlets, call bell pushes and regulators shall be fixed in flush pattern inside metal boxes conforming to para 34.4.4.3.1.9. Accessories like ceiling roses, brackets, battens, staff pendants etc. shall be fixed on metal outlet boxes.

**34.4.3.5.6** Aluminum alloy or brass or cadmium plated iron screws, shall be used to fix the accessories to their bases.

**34.4.3.5.7** The block, board shall (normally) be mounted with their bottom 1.25 metre from floor level

**34.4.3.6 Fans, regulators and clamps:**

**34.4.3.6.1** Ceiling fans :

(a) Ceiling fans including their suspension shall conform to IS:374-1979.

(b) All ceiling fans shall be wired to ceiling roses or to special connector boxes and suspended from hooks of shackles with insulators between hooks and suspension rods. There shall be no joint in the suspension rod.

(c) For wooden joists and beams the suspension shall consist of M. S. flat of size not less than 40 mm x 6 mm secured on the sides of the joists or beams by means of two coach screws of size not less than 5 cm for each flat. Where there is space above the beam, a through-bolt of size not less than 1.5 cm dia shall be placed above the beam from which the flats are suspended. In the later case the flats shall be secured from movement by means of another bolt and nut at the bottom of the beam. A hook consisting of M. S. rod of size not less than 1.5 cm dia. shall be inserted between the M. S. flat through oval holes on their sides. Alternatively the flats may be sent inwards to hold tightly between them by means of a bolt and nut, a hook of 'S' form.

(d) In the case of I beams, flats shall be shaped suitably to catch the flanges and shall be held together by means of a long bolt and nut.

(e) For concrete roofs, ceiling fan hooks shall be got buried in the concrete during construction. The specifications and shape shall confirm to specification given under para 13.3.12 of chapter 13.

(f) Canopies on top of suspension rod shall effectively hide the suspension.

(g) The leading in-wire shall be of nominal cross sectional area not less than 1.5 sq.mm. and shall be protected from abrasion.

(h) The fan body should be bonded to an earth continuity conductor.

(i) Unless otherwise specified, all ceiling fans shall be hung not less than 2.4 m. above the floor and 0.3 m from the bottom of the ceiling/false ceiling. Where room height permits, the optimum height for a fan would be 2.75 m .

**34.4.3.6.2 Exhaust fan :**

(a) Exhaust fan shall conform to relevant Indian Standards.

(b) Exhaust fans shall be erected at the places indicated by the Engineer-in-charge. For fixing an exhaust fan, a circular hole shall be provided in the wall to suit the size of the frame, which shall be fixed by means of the rag bolts embedded in the wall. The hole shall be neatly plastered to the original finish of the wall. The exhaust fan shall be connected to exhaust fan point which shall be wired as near to the hole as possible by means of a flexible cord, care being taken that the blades rotate in the proper direction. The exhaust fan body should be bonded to an earth continuity conductor.

(c) For exhaust fans for installation in corrosive atmosphere the exhaust fan shall be painted with special PVC paint or Chlorinated rubber paint (Chloro rubber paint)

(d) Installation of exhaust fans in kitchens, dark rooms and such other special locations need careful consideration.

**34.4.3.6.3** The regulators of ceiling fans/exhaust fans, if made of metal, shall be connected to earth by loop earthing.

**34.4.3.7 Interchangeability:**

Similar parts of all switches, lamp holders, distribution fuse boards, switchgears, ceiling roses, brackets, pendants, fans and all other fittings of the same type shall be inter-changeable in each installation.

**34.4.4 Methods Of Internal Wiring:**

**34.4.4.1 Tough Rubber Sheathed or PVC Sheathed Wiring System:**

**34.4.4.1.1** *General:* Wiring with tough rubber-sheathed cable is suitable for low voltage installation, and should not be used in places exposed to sun and rain nor in damp places, but may be installed in the above places, provided wires are sheathed in special approved protective covering against atmosphere and well protected to withstand dampness and wiring with PVC sheathed cables is suitable for medium voltage installation and may be installed directly under exposed conditions of sun and rain or damp places.

**34.4.4.1.2** Attachment to Walls and Ceiling: All sheathed cables on brick walls, stone or plaster walls and ceilings, steel joists, or any structural steel work shall be run on well seasoned perfectly straight and well varnished on four sides teak wood batten not less than 10 mm finished thick and the width of which is such as to suit total width of cables laid on the batten. Prior to erection, these shall be painted with one coat

of varnish conforming to IS 347-1975 or approved distemper or approved paint of colour to match with the surroundings. These battens shall be secured to the walls and ceilings by flat head wood screws to wood plugs or other approved plugs (see 34.5.11) at an interval not exceeding 75 cm. The flat head wood screws shall be counter sunk within the wood batten and smoothed down with file.

Where, wiring is to be carried along the face of rolled steel joist, a wooden batten of adequate width shall first be laid on the same and clipped to it as inconspicuously as possible. The wiring should then be fixed to this backing in the ordinary way where wiring passes through structural steel work, the holes shall be suitably bushed to prevent abrasion of cables.

This method of wiring shall .in no case be run above false ceiling without the approval of Engineer- in-charge.

**34.4.4.1.3** *Link clips:* Only tinned brass link clips or point clips shall be used. Link clips or joint clips shall be so arranged that one single clip shall not hold more than two twin core TRS or PVC sheathed cables up to 2.5 sq mm above which a single clip shall hold a single twin core cable or two single core cables.

The clips shall be fixed on varnished wood battens with brass pins or brass screws and spaced at intervals of 10 cm in the case of horizontal runs and 15 cm in the case of vertical runs.. For the wiring and runs of mains exposed to heat and rain, clips specially made for outdoor use from a durable metal, resistant to weather and atmospheric corrosion shall be used.

**34.4.4.1.4** Protection of TRS or PVC sheathed wiring from Mechanical damages.

In case where there are chances of any damage to the wiring, such wiring shall be covered with sheet metal protective' covering the base of which is made flush with the plaster or brick work, as the case may be or the wiring shall be drawn through a conduit pipe complying with all requirements of conduit wiring.

Such protective covering shall in all cases be fitted on all down drops within 5.5 m from the floor.

**34.4.4.1.5** *Bends in wiring:* The wiring shall not in any circumstances be bent so as to form a right angle but shall be rounded off at the comers to a radius not less than six times the overall diameter of the cable.

**34.4.4.1.6** *Passing through floors:* All cables taken through floors shall be enclosed in an insulated heavy gauge steel conduit extending 1.5 m above the floor and flush with the ceiling below, or by means of any other approved type of metallic covering. The ends of all conduits or pipes shall be neatly bushed with porcelain, wood

or other approved material. The conduit pipes wherever accessible shall be securely earthed.

**34.4.4.1.7** *Passing through walls:* The method to be adopted shall be that laid down under 34.4.2.10.1.1 or 34.4.2.10.1.2. In the latter case, there shall be one conduit for every twin core cable or two runs of single-core cable, and the conduit shall be neatly arranged so that the cables enter them straight without bending.

**34.4.4.1.8** *Buried Cables:* The tough rubber-sheathed cables shall not be buried directly in plaster. Where so specified, they may be taken in teak wood channelling of ample capacity or cement chase or conduit pipe buried in the wall.

**34.4.4.1.9** *Stripping of Outer Covering:* While cutting and stripping of the outer covering of the cables, care shall be taken that the sharp edge of the cutting instrument does not touch the rubber or PVC sheathed insulation of conductors. The protective outer covering of the cables shall be stripped off near connecting terminals and this protective covering shall be maintained up to the close proximity of connecting terminals as far as practicable. Care shall be taken to avoid hammering on link clips with any metal instruments, after the cables are laid.

**34.4.4.1.10** *Joints:* Where joint box system is specified joints shall be made by means of connectors, insulated with porcelain or other approved material and enclosed in joint boxes. The joint boxes shall be of size 10cm x 10 cm minimum and shall be so constructed as to prevent insects from entering them and allow the white washing of the walls without water having access to the connections. The joint boxes shall be made moisture proof with an approved plastic compound. All cables shall be bonded through or across these boxes. Bonding connections shall be so arranged as not to come in contact with plaster.

**34.4.4.1.11** *Painting:* If so required, the tough rubber sheathed wiring shall, after erection, be painted with one coat of oil-less paint or distemper of suitable colour over a coat of oil-less primer, and the PVC sheathed wiring shall be painted with a synthetic enamel paint of quick drying type.

**34.4.4.2 Metal sheathed wiring system:**

**34.4.4.2.1** *General:* Metal-sheathed wiring system is suitable for low voltage installation and shall not be used in situations where acids and alkalies are likely to be present. Metal-sheathed wiring may be used in places exposed to sun and rain provided no joint of any description is exposed, this system may be installed in damp places with approved protection against dampness coming in contact with open ends of cables.

**34.4.4.2.2** *Link clips:* Only tinned brass link clips or joint clips shall be used. Link clips or joint clips shall be so arranged that one single clip shall hold more than two twin core metal sheathed cables up to 2.5 mm<sup>2</sup> above which a single clip shall hold a single twin core cable. The clips shall be fixed on varnished wood battens with brass pins or brass screws and placed at intervals of 10 cm in the case of horizontal runs and 15 cm in the case of vertical runs. For the wiring and runs of mains exposed to heat and rain, clips specially made for the outdoor use from a durable metal, resistant to weather and atmosphere corrosion, shall be used.

**34.4.4.2.3** *Attachment to Walls and Ceilings:* All metal sheathed cables on brick walls, stone walls or plastered walls and ceilings, steel joists or any structural steel work shall be run on well seasoned and perfectly straight teak wood battens of not less than 10 mm finished thickness, which have been well varnished on four sides. The width of teak wood battens shall be such as to suit the total width of cable-s laid on the batten. Prior to erection, these shall be painted with one coat of varnish (conforming to IS:347-1975) or approved paint of colour to match with the surroundings. These battens shall be secured to the walls and ceilings by flat head wood screws to wood plugs or other approved plugs at an interval not exceeding 75 cm, the flat head wood screws shall be counter sunk within wood batten and smoothed down with file.

**34.4.4.2.4** *Wiring on Rolled Steel Joists:* Where wiring is to be carried along the face of rolled steel joists a wooden batten shall first be laid on the joist and clipped to it as inconspicuously as possible. The wiring shall be fixed to the batten in the ordinary way.

**34.4.4.2.5** *Protection of Wiring from Mechanical Damage:* In cases where there are chances of any damage to the wiring such wiring shall be covered with sheet metal protective covering the base of which is made flush with the plaster or brickwork, as the case may be or the wiring shall be drawn through a steel conduit pipe (see IS:9537 Pt.II. 1981 & IS:9537 Pt.III 1983) by complying with all requirements of conduit system of wiring.

The protective covering shall in all cases be carried right through the entire length of such doubtful positions.

**34.4.4.2.6** *Joints:* Where joint box system is specified, joints shall be made by means of connectors insulated with porcelain, or other approved materials and enclosed in joint boxes. The joint boxes shall be so constructed as to prevent insects from entering them, and to allow the white washing of the walls without water having access to the connectors. All cables shall be bonded through, or across these boxes. Bonding connections shall be so arranged as not to come in contact with plaster.

**34.4.4.2.7** *Stripping of Insulation and Outer Covering:* When rubber or PVC insulation has to be stripped for joints, the metal sheathing shall be nicked only, not cut, and the insulation between the metal sheath and the conductors shall be of rubber or PVC sheath only. All tapes shall be stripped off. Where paper insulated metal-sheathed cable is used, all openings in the same shall be efficiently sealed.

While cutting and stripping of the outer covering of the cables, care shall be taken that the sharp edge of cutting instrument does not touch the rubber or PVC insulation of conductors. While connecting conductors to the connecting terminals of accessories, care shall be taken to remove cotton tape covering from the top of rubber insulation of cables. The cotton tape covering shall always remain inside lead covering of cables.

**34.4.4.2.8** *Passing through floors:* All cables taken through floors shall be enclosed in an insulated steel conduit (See IS:9537 (Pt.II) -1981 & IS:9537 (Pt.III) -1983) extending 1.5 m. above the floor and flush with the ceiling below, or protected by means of any other approved type metallic covering. The ends of all conduits or pipes shall be neatly bushed with porcelain, wood or other approved material.

**34.4.4.2.9** *Passing through walls:* The method to be adopted shall be that laid down under 34.4.2.10.1.1 or 34.4.2.10.1.2. In the latter case there shall be one conduit for every twin-core cable or two runs of single S. core cable and the conduits shall be neatly arranged so that the cables enter them straight without bending.

**34.4.4.2.10** *Buried cables:* Metal sheathed cables shall in no case be buried directly in the plaster or under any masonry work.

**34.4.4.2.11** *Earthing:* Precautions shall be adopted to ensure that all lead sheathing including portable appliance with exposed metal parts, together with all joint boxes and other similar receptacles laid down under para 34.4.6 and made electrically continuous through their lengths by means of soldered joints or approved suitable clamps or alternatively with earth continuity conductors (earth bonded cables) specially manufactured for the purpose. The earthing shall extend to all main switches, distribution boards etc, in compliance with I.E. rules, 1956 (see Appendix A) as well as manufacturers design and instructions in connection with earthing of all insulated micro gap main switches or similar fittings.

**34.4.4.2.12** *Testing:* The electrical resistance of the metal sheathing together with the resistance of the earthing lead, measured from the connection with the earth electrode to any other position in the completed installation shall not exceed one ohm.

**34.4.4.2.13** *Painting:* Where required, all metal-sheathed wiring or its protective covering when such is fitted, shall be neatly painted after erection with two coats of Zinc paint.

**34.4.4.3 Conduit wiring system:**

**34.4.4.3.1** Surface conduit wiring system:

**34.4.4.3.1.1** *General:* Conduit Wiring shall be provided for places where wiring is likely to receive mechanical damage and where damp situations exist.

Gas, water or steam pipes shall not be used for the protection of conductors.

All accessories shall be of approved design and of metal construction conforming to relevant IS.

Ends or outlets of conduits shall be provided with suitable screwed bushes.

Ends of conduits shall enter and be mechanically secured to the switch, fuses, control gear, motor terminal box, etc. In certain applications it may be necessary to use galvanized or copper plated flexible tubing or suitable quality which shall be mechanically secured by approved type of coupling. Flexible conduit shall not be used for general wiring. It may be used for connection between switch and starter or for a maximum distance of 60 cm to connect an apparatus. Such flexible conduits should have separate earth continuity wire bonded at either end to the conduit and or the apparatus.

All exposed screw threads or other bare parts shall be coated with rust-proof paint. Joint boxes, drawing in boxes and inspection bends shall be complete at all times with metal covers secured by adequately spaced screws.

**34.4. 4.3. 1 .2** *Types and Size of Conduit:* All conduit pipes shall be conforming to IS:9537(Pt.II)1981, finished with galvanized, or stove enameled surface or I.S. 9537 Part III 1983. All conduit accessories shall be of threaded type and under no circumstances, pin grip type or clamp type accessories be used. The conduit wiring system shall be complete in all respect including accessories. No steel conduit less than 16 mm in dia shall be used. The number of insulated conductors that can be drawn into rigid steel conduit are given in table below:



MAXIMUM PERMISSIBLE NUMBER OF 250 V GRADE SINGLE - CORE CABLES THAT CAN BE DRAWN INTO RIGID STEEL CONDUITS.

SIZE OF CABLE		SIZE OF CONDUIT (MM)									
Nominal Cross Sectional Area mm sq	Number of Wires Diameter (in mm)	16	20	25	32	40	50	63	(Number of Cables, Max.)		
1.0	1/1.12 *	5	4	7	5	13	10	20	14	-	
1.5	1/1.4	4	3	7	5	12	10	20	14	-	
2.5	{1/1.8}										
	{3/1.06*}	3	2	6	5	10	8	18	12		
4	{1/2.24}										
6	{7/0.8.5*}										
		3	2	4	3	7	8	12	10	-	
	{1/2.80}										
	{7/1.06*}	2	-	3	2	6	5	10	8		
10	{11/3.55+}	-	-	2	-	5	4	8	7		
	{7/1.40*}	-	-	2	-	4	3		6	5 8 6	
16	7/1.70	-	-	-	-	2	-	4	3	7 6 -	
2.5	7/2.24	-	-	-	-	-	-	3	2	5 4 8 6 9	
3.5	7/2.50	-	-	-	-	-	-	2		4 3 7 .5 8	
50	{7/3.00+}										
	{19/1.80}	-	-	-	-	-	-	-	-	2 - .5 4 6	

Note: 1- The table shows the maximum capacity of conduits for the simultaneous drawing of cables. The columns headed 'A' apply to runs of conduit which have distance not exceeding 4.25 m between draw - in boxes, and which do not deflect from the straight by an angle of more than 15°. The columns headed B apply to runs of conduit which deflect from the straight by an angle of more than 15°.

Note: 2- In case an inspection type draw - in box has been provided and if the cable is first drawn through one straight conduit, then through the draw - in box, and then through the second straight conduit, such system may be considered as that of a straight conduit even if the conduit deflects through the straight by more than 15°.

\* For copper conductors only.

**34.4.4.3.1.3** *Bunching of cables:* Unless otherwise specified insulated conductors of AC supply and DC supply shall be bunched in separate conduits. Cables carrying alternating current if installed in metal conduit shall always be bunched such that the outgoing and return cables are drawn into the same conduits.

**34.4.4.3.1.4** *Conduit Joints:* Conduit pipes shall be joined by means of screwed couplers and screwed accessories only. In long distance straight runs of conduit, inspection type couplers at reasonable intervals shall be provided or running threads with couplers and jam-nuts (in the latter case the bare threaded portion shall be treated with anti-corrosive preservative ) shall be provided. Thread on conduit pipes in an cases shall be between 13 mm to 27 mm long, sufficient to accommodate pipes to full threaded portion of couplers or accessories. Cut ends of conduit pipes shall have no sharp edges nor any burrs left to avoid damage to the insulation of conductors while pulling them through such pipes. Separate lengths of conduits, etc., after they have been prepared may if required, be submitted for inspection to the Engineer-in-Charge before being fixed.

**34.4.4.3.1.5** *Protection against dampness:* In order to minimise condensation or sweating inside the tube, all outlets of conduit system shall be properly drained and ventilated but in such a manner as to prevent the entry of insects as far as possible.

**34.4.4.3.1.6** *Protection of conduit against rust :* The outer surface of the conduit pipes, including all bends, unions, tees, junction boxes etc. forming part of the conduit system shall be adequately protected against rust particularly when such system is exposed to weather. In all cases, no bare threaded portion of conduit pipe shall be allowed unless such bare threaded portion is treated with anti-corrosive preservative or covered with approved plastic compound.

**34.4.4.3.1.7** *Fixing of conduit:*

(a) Conduit pipes shall be .fixed by heavy gauge saddles, secured to suitable wood plugs or any other approved plugs with screws in an approved manner at an interval of not more than one metre, but on either side of couplers or bends or similar fittings, saddles shall be .fixed at a distance of 30 cm from the centre of such fittings. The saddle should not be less than 24 gauge for conduits up to 25 mm dia and not less than 20 gauge for larger diameter.

(b) When conduit pipes are to be laid along the trusses, steel joints, etc., the same shall be secured by means of ordinary clips or girder clips as required by the Engineer-in-charge. Where it is not possible to drill holes in the truss members, suitable clamps with bolts and. nuts shall be used. The width and thickness of the ordinary clip or girder clips and clamps shall not be less than as stated below:

For clamps or ordinary clips:

Sizes of conduit	Width of saddle clip (mm)	Thickness of clip(mm)
16mm	15	0.71
20mm	20	0.90
25mm	20	0.90
32mm	25	1.25

**3.4.4.3.1.8** *Bends in conduit:* All necessary bends in the system including diversions shall be done by bending pipes; or by inserting suitable solid or inspection type normal bends, elbows or similar fittings; or by fixing cast-iron inspection boxes whichever is more suitable as per relevant IS. Conduit fittings shall be avoided as far as possible on conduit system exposed to weather; where necessary solid type fittings shall be used. No length of conduit shall have more than the equivalent of four quarter bends from outlet to outlet, the bends at the outlets not being counted.

**34.4.4.3.1.9** *Outlets:* All outlets for fittings, switches, etc. shall be boxes of suitable metal or any other approved outlet boxes for either surface mounting or flush mounting system as required. The switch or regulator box shall be made of metal on all sides except on the front. In the case of cast iron boxes, wall thickness shall be atleast 3 mm and in the case of welded mild steel sheet boxes, the wall thickness shall not be less than 18 gauge. For boxes upto the size of 20 cm x 30 cm and above this size 16 gauge M. S. boxes shall be used. Except where otherwise stated atleast 3 mm thick phenolic laminated sheets shall be fixed on the front with aluminum alloy/brass/cadmium plated iron screws as approved by the Engineer-in-charge. All switches except piano type switches, socket outlets and fan regulators shall be fixed on wooden/metal strips which shall be screwed/welded to the box. For boxes made of insulating material, the thickness of walls and base shall not be less than 2mm. The metal box shall be earthed.

**34.4.4.3.1.10** *Painting of conduits and accessories:* After installation, all accessible surfaces of conduit pipe fittings, switch and regulator boxes etc., shall be painted in compliance with para 34.4.7.3.

**34.4.4.3.1.11** *Conductors;* All conductors used in conduit wiring shall preferably be stranded. No single-core cable of nominal cross-sectional area greater than 130 mm<sup>2</sup> shall be enclosed along in a conduit and used for alternating current.

**34.4.4.3.1.12** *Erection and earthing of conduit:* The conduit of each circuit or section shall be completed before conductors are drawn in. The entire system of conduit after erection shall be tested for mechanical and electrical continuity throughout and permanently connected to earth conforming to the requirements specified under para 34.4.6.11 by means of special approved type earthing clamp efficiently fastened to

conduit pipe in a workman like manner for a perfect continuity between each wire and conduit. Gas or water pipes shall not be used as earth medium. If conduit pipes are liable to mechanical damage they shall be adequately protected. In a conduit system, pipe must be continuous when passing through walls or floors.

**34.4.4.3.1.13** *Metal* conduit pipe not to be used as an earth continuity conductor: Metal conduit pipe should not generally be used as an earth continuity conductor. A separate earth continuity conductor of size not less than 14 SWG tinned copper bare wire shall be used as an earth continuity conductor for earthing of metal outlet boxes and of appliances through 3 pin plugs and sockets. This earth continuity conductor may be threaded inside the conduit pipe or bound spirally outside on the conduit as directed by the Engineer-in-charge.

**34.4.4.3.2** *Recessed conduit wiring system:*

**34.4.4.3.2.1** *General:* Recessed conduit wiring system shall comply with all the requirements for surface conduit wiring system and in addition conform to the requirements specified in the following clauses:

**34.4.4.3.2.2** The chase in the wall shall be neatly made and be of ample dimensions to permit the conduit to be fixed in the manner desired. In the case of buildings under construction chases shall be provided in the wall, at the time of their construction. The conduits shall be buried in the wall before plastering and shall be filled up neatly after erection of conduit. In case of exposed brick/rubble masonry work, special care shall be taken to fix the conduit and accessories in position along with the building work.

**34.4.4.3.2.3** *Conduit cast in Concrete slabs:* Where conduits are to be cast in concrete slabs, the boxes and conduits are held in position by blocks and iron wire fastened to the reinforcing bars. The concrete is then poured and tamped. For structural reasons these runs of conduits are normally close to the bottom surface or near the internal portion of the floor slab.

In general, the following rules should be observed:

- (a) Conduits shall not have an outer diameter greater than one third of the slab thickness as measured at its thinnest point.
- (b) Conduits running parallel to each other shall be spaced not less than three times the outer diameter of the largest conduit centre-to - centre.

- (c) Conduits running parallel to beam-axis shall not run above beams.
- (d) Conduit Crossings shall be as near to a right angle as possible.
- (e) Minimum cover over conduits shall be 19 mm.

**34.4.4.3.2.4** *Air conditioning and heating:*

Where conduits are used for carrying insulated electrical conductors and when such conduits pass from a non air-conditioned area into an air conditioned area or into a fan chamber or duct a junction box shall be installed or other means shall be adopted to break the continuity of such conduit at the points of entry or just outside and the conduit shall be sealed round the conductors, to prevent air being carried from one area into the other through the conduit and thereby giving rise to the risk of condensation of moisture inside the conduits. The same method applies equally to other types of wiring, like wood sheathing or ducts which allow air to pass through around the conductors.

**34.4.4.3.2.5** *Inspection boxes:* Suitable inspection boxes shall be provided to permit periodical inspection and to facilitate removal of wires IT necessary. These shall be mounted flush with the wall. Suitable ventilating holes shall be provided in the inspection box covers.

**3.4.4.3.2.6** - *Types of accessories to be used:* All outlets such as switches and wall sockets may be either of flush mounting type or of surface mounting type as required.

(a) *Flush mounting type:* All flush mounting outlets shall be on cast-iron or mild steel sheet boxes with a cover of approved insulating material. The switches and other outlets shall be mounted on such boxes as would be approved. The metal box shall be efficiently earthed with conduit by an approved means of earth attachment.

(b) *Surface mounting type:* If surface mounting type outlet box is specified it shall be of any approved insulating material and outlets mounted in an approved manner.

**34.4.4.3.2.7** To facilitate drawing of wires in the conduit, G.I. fish wire of 10 SWG shall be provided along with the laying of recessed conduit.

**34.4.4.4** Non metallic conduit wiring system (PVC rigid conduits).

**34.4.4.4.1** *General:* Rigid Non-metallic conduits are used for surfaced and recessed conduits wiring in low and medium voltage installations.

**34.4.4.4.2** Rigid non-metallic conduits shall conform to I.S 9537(Part-3) 1983 and their fittings shall conform to I.S.3419-1976.

**34.4.4.4.3** The non metallic conduit shall be protected up to a height of 1.5 metres from floor against mechanical damage.

*c*

**34.4.4.4.4** *Earth continuity conductor:* Where rigid non-metallic conduits are used in conjunction with metal junction boxes, an earth continuity wire shall run within the conduit and all such metallic boxes shall be earthed efficiently through the earth continuity wire.

**34.4.4.4.5** The exterior surfaces of the conduit shall be reasonably free from grooving and other defects. The interior of the conduits shall be free from obstructions which might cause abrasion of cables or which might interfere with the ready introduction or withdrawal of cables of maximum size and number permitted to be enclosed by the conduit.

**34.4.4.4.6** The ends of each length of conduit shall be cleanly cut or formed plane and shall be free from burr.

**34.4.4.4.7** Care should be taken while heating the conduit with a flame to avoid over heating which may lead to blistering or cracking during the bending operation.

#### **34.4.5 Specifications For Bus Bar Chambers For Medium Voltage - Installations.**

**34.4.5.1** *Bus bar chambers :*

**34.4.5.1.1** Bus bar chambers shall be fabricated with M S angles for frame work and covered all round with sheet steel of thickness not less than 1.5 mm in a box form. It shall be provided with detachable covers on all sides fitted with dust excluding gasket, secured with sufficient numbers of cadmium plated iron screws to ensure that covers are dust tight. Bus bar chambers for bus bars of more than 90 cm. length shall have horizontal and vertical stiffeners welded to the main frame.

Alternatively the bus bar chamber shall be made of sheet steel of thickness not less than 3mm with detachable covers on all side.\$ and dust excluding gasket. The joints shall be continuous welded. The detachable-cover shall be secured

to the box with sufficient number of cadmium plated iron screws to ensure dust tightness. This type of bus bar chamber shall be restricted for bus bars up to 90 cm length.

Bus bar chambers of size up to 90 cm shall have detachable end covers so that the same can be extended. Pilot lamp, if provided, shall be housed in separate extended chamber with insulated portion between the bus bar chamber and pilot lamp chamber.

**34.4.5.1.2** The bus bar chamber shall be painted with a coat of primer red oxide paint and finished with two coats of enamel paint of approved shade.

**34.4.5.2** *Bus bars:*

Bus bar shall be made of copper, wrought aluminum alloy conforming to relevant Indian Standards and shall be of sufficient cross section so that a current density of 160 amp./sq.cm in the case of copper and 130 amp/sq cm in the case of aluminum or aluminum alloy is not exceeded at nominal current rating. The cross section of the neutral bus bar shall be the same as that of the phase bus bar for bus bars of capacities up to 200 amps and for higher capacities the neutral bus bar must not be less than half the cross section of that of phase bus bar. The recommended sections of bus bar are given in the following table :

<b>BUS BAR SECTIONS</b>				
Copper			Aluminum	
Current rating in amp upto	Recommended rectangular section in mm	Recommended rectangular cross section in mm	Recommended section tabular	
			Nominal Dia in mm	wall thickness in mm
100	25x4.5	25x6	-	-
200	38x4.5	38x6	-	-

**34.4.5.3** *Bus bar supports and attachments:*

**34.4.5.3.1** *Supports:* Bus bars shall be firmly fixed on supports constructed from a suitably insulated material such as Phenolic laminated sheet. Alternatively bus bars shall be supported on insulators of suitable length conforming to relevant Indian standards. The supports shall be sufficiently strong to effectively withstand electromechanical stresses produced in the event of short circuit.

**34.4.5.3.2** *Connections to bus bars:* (a) The bolts and nuts used for connections to bus bars shall be of aluminum alloy, tinned forged brass or galvanised iron. Suitable precaution shall be taken against heating due to bi-metallic contact.

(b) Further for tapping off connection from bus bars VIR/PVC insulated wire may be used for current capacities upto 100 amp. and for higher current capacities solid conductors / strips suitably insulated with PVC sleeve / tape shall be used adopting trunking arrangement.

**34.4.5.4** *Clearances:*

The minimum clearance to be maintained for open and enclosed indoor air insulated bus bars electrically non exposed and working at system voltages up to 600 volts shall be as follows:- .

Between	Min. Clearances
Phase to earth	26 mm.
Phase to phase	32 mm

**34.4.5.5** *Bus bars markings:* .

**34.4.5.5.1** *The colours and letters (or symbols) for bus bars:* Main bus bars connections and Auxiliary wiring, etc. shall conform to relevant Indian standards. A brief from I. S. 375-1963 is given below for broad guidelines.

For A.C. Bus Bars and Main connections:		
1	2	3
<b>Bus bars and Main Connection</b>	<b>Colour</b>	<b>Letter/symbols.</b>
i		
Three phase	Red, Yellow, blue	R.Y.B
Two phase	Red , Blue	R.B.
Single phase	Red	R
ii		
Neutral connections	Black	N
iii		
Connection to Earth	Green	E
iv		
Phase variable( such as connection to reversible motors).	Grey	GY.

---



**34.4.5.5.2** *Phase sequence and polarity:* Bus bars and roam connections, when marked, shall be marked in accordance with the following table to indicate the order in which the voltages in phases reach their maximum values.

Systems	As indicated by colours or letters.	Phase sequence indicated vector ally
Three phase	Red, Yellow, Blue	R. Y.B.
Two phase	Red, Blue.	R.B.

**34.4.5.6** *Arrangement of Bus Bars and main connections:*

Bus Bars and main connections which are substantially in one plain shall be arranged for A.C. system in order given as follows:

- (i) The order of phase connections shall be Red, Yellow and Blue.
- (ii) When the run of the conductors is horizontal the red shall be on the top or on the left or farthest away as viewed from the front.
- (iii) When the run of the conductor is vertical the red shall be on the left or farthest away as viewed from the front
- (iv) When the system has a neutral connection in the-same phase as the phase <:connections, the neutral shall occupy an outer position.
- (v) Unless the neutral connections can be readily distinguished from the phase connections the order shall be red, yellow, blue and black.

### 34.4.6 Earthing:

**34.4.6.1** **General:** The object of an earthing system is- to provide as nearly as possible a system of conductors at a uniform potential and as nearly zero or absolute earth potential as possible. The purpose of this is to ensure that in general all parts of apparatus other than live parts shall be at earth potential as well as to ensure ~at persons coming in contact with it shall be at earth potential at all times.

**System earthing:** Earthing associated with current carrying conductor is normally essential to the security of the system and is generally known as system earthing.

**Equipment earthing:** Earthing of non - current carrying metal work and conductor is essential to the safety of human life, of animals and of property and is generally known as equipment earthing.

As far as possible all earth connections shall be visible for inspection and shall be carefully made; if they are poorly made or inadequate the purpose for which they are intended, loss of life and property or serious personal injury may result. Earthing shall conform to the follow specifications. For other details not covered in this specification IS: 3043 - 1987 shall be referred to.

#### Type of Earth Electrodes:

- (a) Pipe Earth electrode.
- (b) Plate earth Electrode.
- (c) Strip or conductor earth electrode.

#### 34.4.6.2 Selection of earth electrode:

**34.4.6.2.1** G.I. pipe or G.I. plate earth Electrode shall be used except where it is unavoidable to use copper plate earth electrode due to corrosive soil conditions for direct current system or for large capacity substations.

**34.4.6.2.2** Strip or conductor electrode is recommended for hard and rocky soils and in locations where .there are limitations to the use of pipe or plate earth electrode.

34.4.6.2.3 Where the soil is highly corrosive, the earth electrode shall be of copper. Where soil contains sulphur, copper electrode shall be adequately tinned.

**34.4.6.3 Arrangement for earth electrode :**

**34.4.6.3.1** Pipe earth electrode : G.I. pipe shall be of medium class, 38/40 mm dia and 2.50 metres in length. Galvanizing of pipe shall conform to relevant Indian Standards. G.I. pipe electrodes shall be cut tapered at the bottom and provided with holes of 12 mm. Dia drilled not less than 7.5 cm from each other up to 2m of length from bottom. The electrode shall be buried in the ground vertically with its top not less than 20 cm. Below ground level (details shown in fig.1)

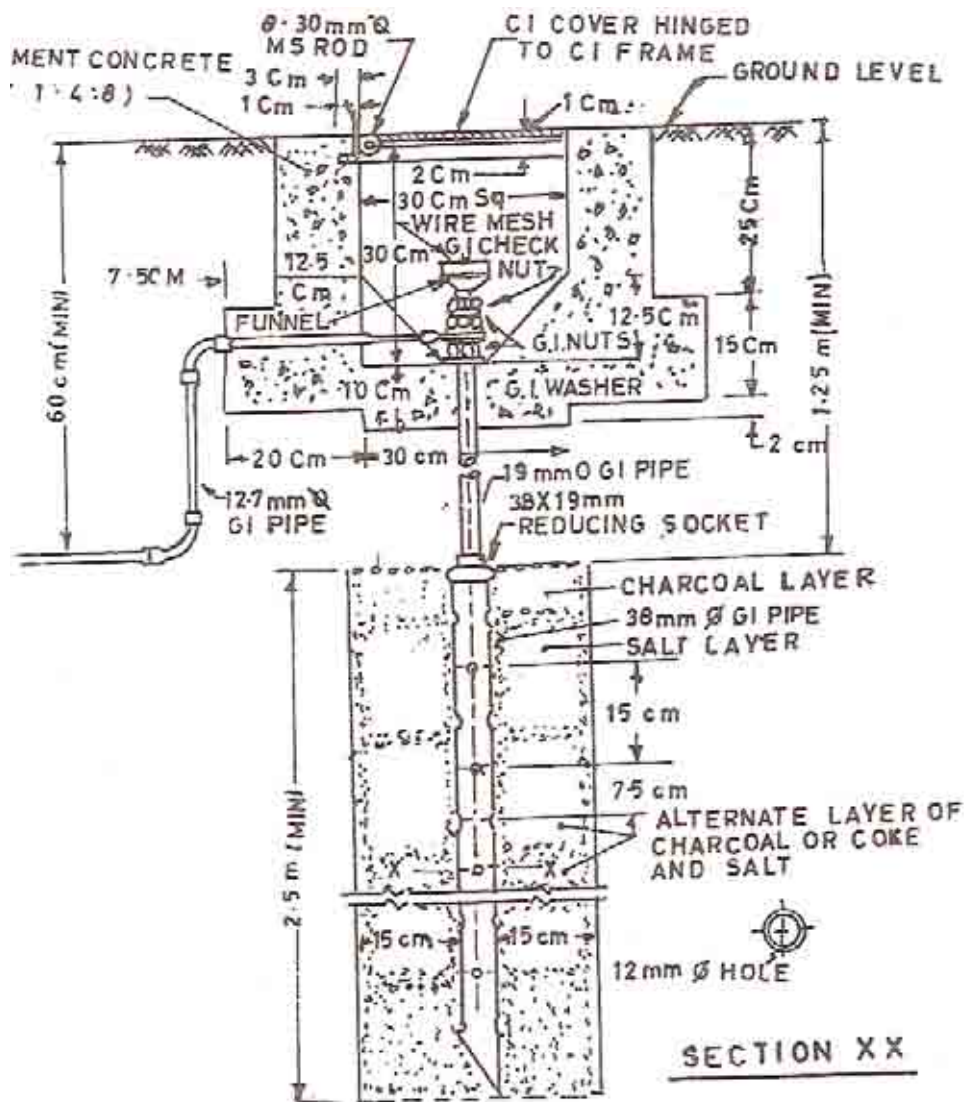

NOTE – THREE OR FOUR BUCKETS OF WATER TO BE POURED IN TO SUMP EVERY FEW DAYS TO KEEP THE SOIL SURROUNDING THE EARTH PIPE PERMANENTLY MOIST

**Fig. 1 TYPICAL ILLUSTRATION OF PIPE EARTH ELECTRODE**

**34.4.6.3.2** *Plate Earth Electrode:* For plate electrodes minimum dimensions of the electrode shall be as under :

- (a) G.I. plate Electrode - 60 cm. x 60 cm. x 6.3 mm. thick.
- (b) Copper plate Electrode - 60 cm. x 60 cm. x 3.15 mm. thick.

The electrode shall be buried in ground with its faces vertical and top not less than 1.5m. below ground level (details shown in the figure 2).

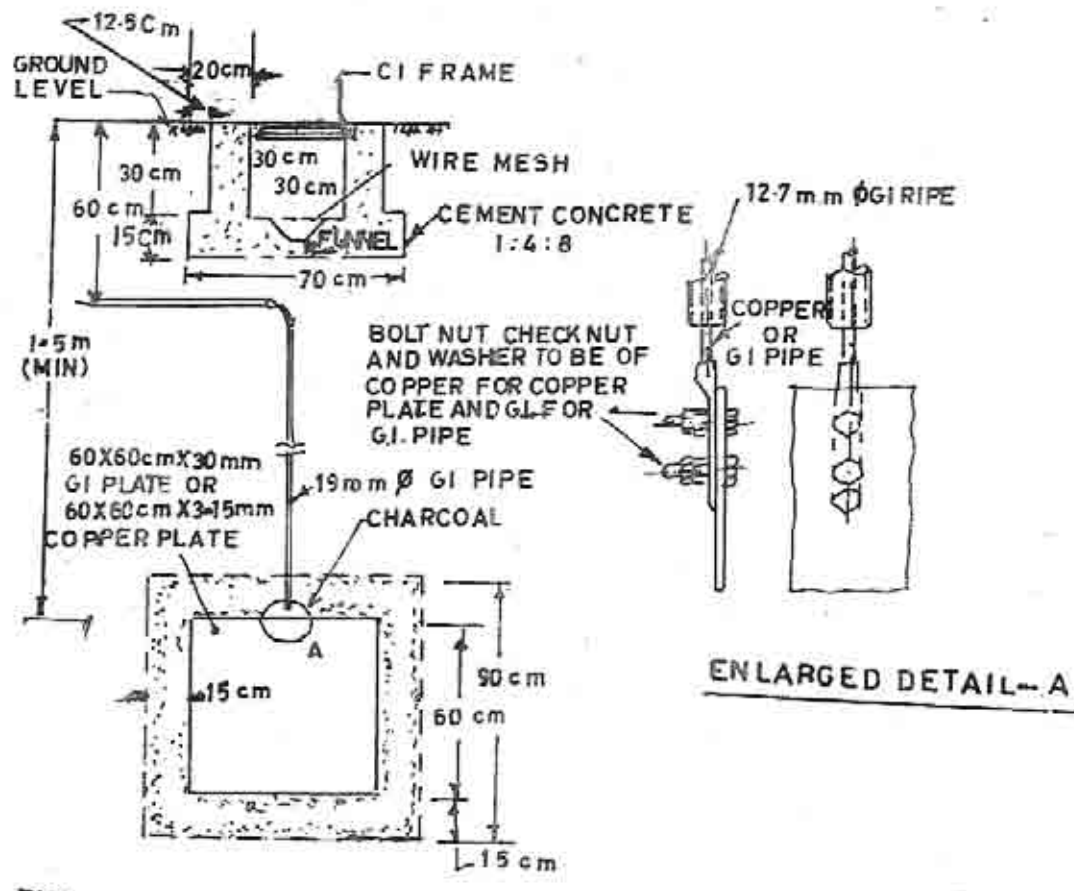

NOTE – THREE OR FOUR BUCKETS OF WATER TO BE POURED IN TO SUMP EVERY FEW DAYS TO KEEP THE SOIL SURROUNDING THE EARTH PIPE PERMANENTLY MOIST

Fig. 2 TYPICAL ILLUSTRATION OF PIPE EARTH ELECTRODE

**34.4.6.3.3 Strip or conductor electrode:**

(a) Strip electrodes shall not be less than 25 mm X 4 mm. of galvanised iron and 25 mm. X 1.6 mm. of copper. For conductor electrode the size of round conductor shall be not less than 6 SWG of G.I. and 8 SWG of copper.

(b) The length of buried strip or conductor earth electrode shall be not less than 1.5m. This conductor length shall be increased if necessary on the basis of the information available about soil resistance, so that required earth resistance is obtained.

(c) The electrode shall be buried not less than 0.5m deep, in a trench either single straight or in a number of trenches radiating from single point.

(d) If conditions necessitate use of more than one strip or conductor electrode, they shall be laid either in parallel trenches or in radial trenches.

**34.4.6.4 Method of installing watering arrangement:**

**34.4.6.4.1** In the case of plate earth electrodes a watering pipe of 50 mm. dia of medium class G.I. pipe may be provided and attached to the electrode. A funnel with mesh shall be provided on the top of this pipe for watering the earth. In case of pipe electrode a 40 mm. x 20 mm reducer shall be used for fixing the funnel. The watering funnel attachment shall be housed in masonry enclosure of not less than 30 cm x 30 cm. x 30 cm.

**34.4.6.4.2** A cast iron M. S. frame with cover having locking arrangement shall be suitably embedded in the masonry enclosure, or a cover of R.C.C. slab of size 33.8 cm x 33.8 cm and thickness 38 to 40 mm. be provided.

**34.4.6.5 Location of earth electrode:**

**34.4.6.5.1** Normally an earth electrode shall not be situated less than 1.5 m. from any building. Care shall be taken that excavations for earth electrode may not affect the column footings or foundation of the building; in such cases electrode may be further away from the building.

**34.4.6.5.2** The location of the earth electrode will be such where the soil has reasonable chance of remaining moist, as far as possible. Entrances, pavements and road ways, are definitely avoided for locating the earth electrode.

**34.4.6.6 Artificial treatment of soil:**

In case there is no option of site and earth electrode resistance is high, the earth electrode resistance shall be reduced by artificial chemical treatment of the soil. For this purpose, the most commonly used substances are sodium chloride (common salt), calcium chloride, sodium carbonate, copper sulphate and salt mixed with soft coke or charcoal in suitable proportion. But before any chemical treatment is applied possible corrosive effect on the electrode material and connections must be taken into consideration. When this treatment is resorted to, the electrode shall be surrounded by charcoal/ coke and salt as indicated in fig. 1 & 2. This treatment of soil shall be specified in the schedule of work and in such cases, excavation for earth electrode shall be as per dimensions indicated in fig. 1 & 2.

**34.4.6.7 Size of earthing lead:**

**34.4.6.7.1 Main earthing lead:** The main earthing lead shall be of G.I. wire or G.I. strip in the case of G.I. pipe earth electrode and G.I. plate earth electrode and copper wire or copper strip in the case of copper earth electrode. For all electrical installations except sub stations and generating station, the earthing lead shall be not less than one half of the sectional area of that of the largest conductor to be protected but that a conductor larger than 100 sq. mm. nominal cross sectional area in case of copper conductor and 150 sq. mm. in case of G.I. conductor need not be used. The minimum size of main earthing lead shall not be less than 8 SWG of copper or G.I. wire and 20 mm. x 2 mm. in case of copper strip or 25mm. x 3 mm. in case of G.I. strip.

**34.4.6.7.2 Size of earth continuity conductor:** The nominal minimum cross sectional area of an earth continuity conductor not contained within a cable or flexible cord shall be 14 SWG copper or 12 SWG of G.I.

**34.4.6.8 Method of connecting earthing lead to earth electrode:**

**34.4.6.8.1** The earthing lead should be connected to the earth electrode by means of lugs soldered or crimped.

**34.4.6.8.2** In the case of plate earth electrode the earthing lead shall be securely bolted to the plate with two bolts, nuts, checknuts and washers. In the case of pipe earth electrode, it shall be connected by means of a through bolt, nuts and washers. Alternatively the G.I. strip may be clamped near the top end of the G.I. pipe electrode the strip being dished suitably at the end portion coming in contact with the G.I. pipe and earth lead lug shall be securely bolted to this strip with two bolts, nuts, checknuts and washers.

**34.4.6.8.3** The materials used for connecting the earth lead with electrode shall be of G.I. in case of G.I. pipes and G.I. plate earth electrodes and of tinned brass in case of copper plate electrode.

**34.4.6.8.4** The earthing lead shall be securely connected at the other end to the earth studs provided on the main board / SDBS by means of soldering and lugs.

**34.4.6.8.5** Loop earthing shall be provided for all mountings of main board and other metal plate switches and distribution fuse boards with not less than 14 SWG copper or 12 SWG G.I. or 4 sq.mm. aluminum wire.

**34.4.6.9** *Protection of earthing Lead :*

~

The earthing lead from electrode onwards shall be suitably protected from mechanical injury by a 15 mm. dia. G.I pipe in case of wire and by 40 mm. dia. medium class G.I. pipe in case of strip. Portion of this protection pipe within ground shall be buried at least 30 cm. deep (to be increased to 60 cm. in case of road crossing and pavements). The portion shall be recessed in walls and floors' to adequate depth.

**34.4.6.10** *Number of earth electrodes in Medium voltage Installations :*

In medium voltage installations, where there are a number of motors or other equipments to be earthed, at least a minimum of 2 number earth electrodes (interconnected with an earth bus) should be provided for earthing of equipment. See also below. The number of electrodes has to be increased if lower earth circuit impedance is required. The distance between two electrodes shall not be less than twice the length of the electrodes. The earth resistance of any single earth electrode should not normally exceed 5 ohms. The earth resistances of a number of rods or pipes connected together in parallel is practically proportional to the reciprocal to the number of electrodes used.

**34.4.6.11** *Equipment and portions of installations which shall be earthed:*

**34.4.6.11.1** Except for equipment provided with double insulation, all the non-current carrying metal parts of the installation are to be earthed properly. All metal conduits trunking cable sheaths, switchgears, distribution fuse boards, lighting fittings and other parts made of metal shall be bonded together and connected by means of two separate and distinct conductors to an efficient earth electrode.

**34.4.6.11.2** Earthing of metallic parts shall not be affected through any structural metal work which houses the installation. Where metallic parts of the installation are not required to be earthed and liable to become alive should the insulation of the conductors become defective, such metallic parts shall be separated by durable non-conducting material from any structural work.

**34.4.6.11.3** The relevant portions of the Indian Electricity Rules i.e. Rules 32, 51, 61, 62, 67, 69, 88(2) and 90 shall apply (see Appendix A).

### 34.4.6.12. **Earth circuit Impedance:**

In installations where the apparatus is protected by fuses the total earth circuit impedance shall not be more than that obtained by the following graph given in fig. 3

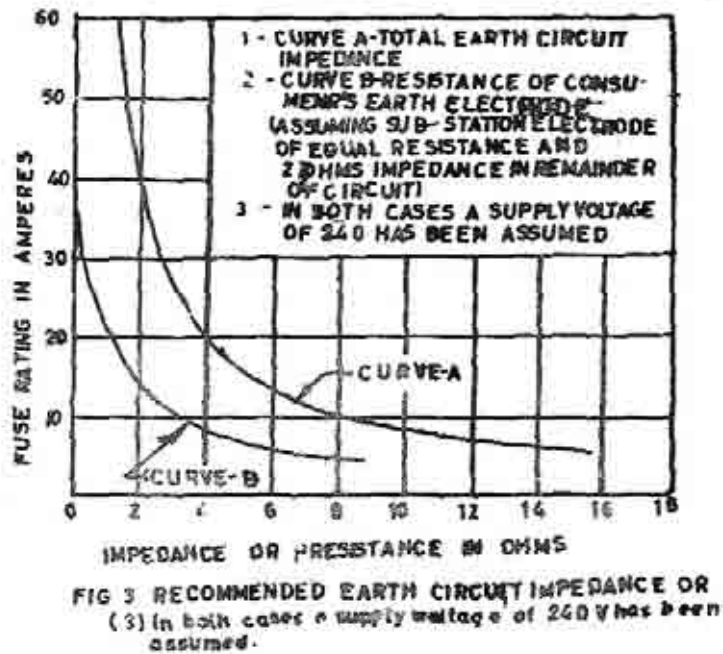

Fig. 3 Recommended Earth Circuit Impedance

### 34.4.7 **Painting:**

#### 34.4.7.1 **Painting work in general:**

34.4.7.1.1 **Paints:** Paints, oils, varnishes, .etc., of approved make in original tin to the satisfaction of the Engineer-in-Charge shall only be used.

34.4.7.1.2 **Preparation of the surface:** The surface shall be thoroughly cleaned and dusted, before painting is started. The proposed surface shall be inspected by the Engineer-in-Charge or his authorised agent and shall have received the approval before painting is commenced.

."

34.4.7.1.3 **Application:** Paint shall be applied with the brush. The paint shall be spread as smooth and even as possible. Particular care should be paid to rivets, nuts, bolts & every lapping. Before drying out, it shall be continuously stirred in the smaller containers with a smooth stick while it is being applied.

Each coat shall be allowed to dry out sufficiently before a subsequent coat is applied.



**34.4.7.1.4** *Scope:* Painting on old surface in indoor situations will not include primer coat except where specially mentioned in the schedule of work or special specification. However, where rust has formed on iron and steel surfaces, the spots shall be painted with one anti-rust primer coat.

**34.4.7.1.5** *Precautions:* All furniture, fixtures, glazing, floors, etc., shall be protected by covering. All stains, smears, splashing, dropping of every kind shall be removed. While painting of wiring, etc., it shall be ensured that painting of wall and ceiling, etc., is not spoiled in any way.

**34.4.7.2** *Painting of wiring on wood bawen :* The wiring shall after erection be neatly painted with two coats of oil less non-cracking paint of suitable colour to match the surroundings to the satisfaction of the Engineer-in-Charge.

**34.4.7.3** *Painting of conduit and accessories:* After installation, all accessible surface of conduit pipes, fittings, switch and regulator boxes, etc., shall be painted with two coats of approved enamel paint or aluminum paint as required to match the finish of surrounding wall, trusses, etc.

#### **34.4.8 Testing Of Installations:**

**34.4.8.1** *General: carried out :* On completion of installations the following tests shall be carried out

1. Insulation Resistance Test.
2. Polarity Test of Switch.
3. Earth Continuity Test.
4. Earth Electrode Resistance Test.

#### **34.4.8.2** *Insulation resistance:*

insulation resistance shall be measured by applying between earth and the whole system of conductors or any section thereof with all fuses in place and all switches closed, and except in earthed concentric wiring all lamps in position 01: both poles of the installation otherwise electrically connected together, a direct current pressure of not less than twice the working pressure provided that it need not exceed 500 Volts for medium voltage circuits. Where the supply is derived from a poly phase A.C. system, the neutral pole of which is connected to earth either direct or through added resistance, the working pressure shall be deemed to be that which is maintained between the phase conductor and the neutral.

**34.4.&2.2** The insulation resistance shall also be measured between all conductors connected to one pole or phase conductor of the supply and all the conductors connected to the neutral or to the other pole or phase conductor of the

supply with all lamps in position and switches in " off" position .and its value shall be not less than that specified Hi para 34.5.2.4.

**34.4.8.2.3** The insulation resistance in Megaohms measured as above shall not be less than  $S.Q$  megaohms. divided by the number of outlets or when PVC insulated cables are used for wiring 12.5 megaohms divided by the number of outlets.

**34.4.8.2.4** Where a whole installation is being tested, lower value than that given by the formula, subject to a minimum of 1 megaohm is acceptable.

**34.4.8.2.5** A preliminary and similar test may be made. before lamps etc., are installed and in this event the insulation resistance to earth should be not less than 100 megaohms divided by the number of outlets or PVC insulated-cables are used for wiring 25 megaohms divided by number of outlets.

**34.4.8.2.6** The term "outlet" includes every point along with every switch except that a switch combined with a Socket outlet, appliance or light fitting is regarded as one outlet.

**34.4.8.2.7** Control rheostats, heating and power appliances and electric signs may, if required, be disconnected from circuit during the test" but in that event the insulation resistance between the case or frame work, and all live parts of each rheostat, appliance and sign, shall be not less. than that specified in the relevant Indian Standard Specification or, where there is no specification shall be not less than half a megaohm.

### **34.4.8.3 Polarity Test of Switch:**

**34.4.8.3.1** In a two wire installation test shall be made to verify that all switches in every circuit have been fitted in the same conductor throughout and such conductor shall be labelled or marked for connection to the phase conductor or to the non-earthed conductor of the supply.

**34.4.8.3.2** In a three wire or a four wire installation a test shall be made to verify that every non-linked single pole switch is fitted in a conductor which is labelled or marked for connection to one of the phase conductor of the supply.

**34.4.8.3.3** The installation shall be connected to the supply for testing. The terminals of all the switches shall be tested by a test lamp", one lead of which is connected to the earth. Glowing of the test lamp of its full brilliance~ when the switch is " on " position irrespective of appliance in position or not, ~ indicate that the switch is connected to the right polarity,

#### 34.4.8.4 Testing of earth continuity path :

The earth continuity conductor including metal conduits and metal conduits envelopes of cables in all cases shall be tested for electric continuity and the electrical resistance of the same along with the earthing lead but excluding any added re- or earth leakage circuit breaker measured from the connection with the earth electrode to any point in the earth continuity conductor in the completed installation shall not exceed one ohm.

#### 34.4.5 Measurement of earth electrode resistance :

34.4.8.5.1 The auxiliary earth electrodes, besides the test electrode, are placed at suitable distance from test electrode (see figA). A measured current is passed between the electrode to be tested and an auxiliary current electrode "C" and potential difference between the electrode "A" and auxiliary potential electrode "B" is measured. The resistance of the test electrode "A" is then given by

$$R = \frac{V}{I}$$

Where,

- R - Resistance of the test electrode in ohms.
- V - Reading of the voltmeter in volts.
- I - Reading of the ammeter in amps.

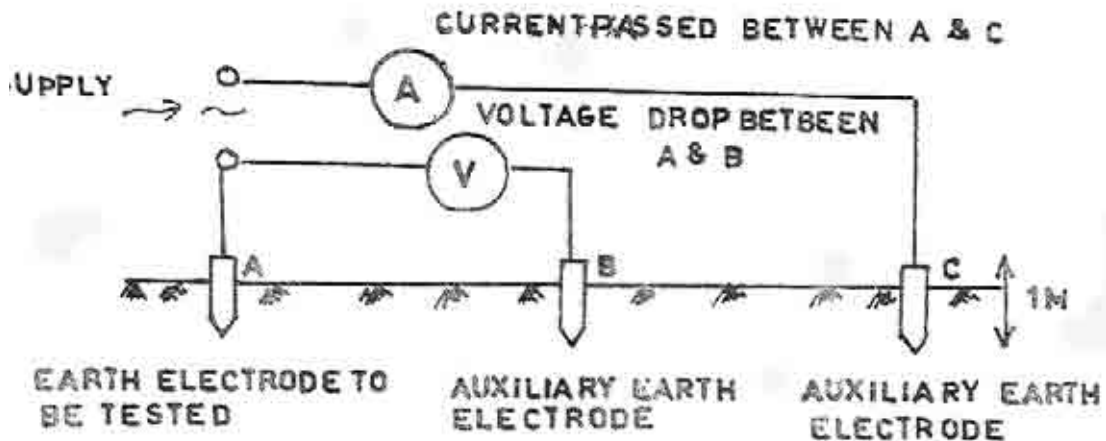

Fig. 4 Method of measurement of earth Electrode Resistance

- 34.4.8.5.2** (a) Stray current flowing in the soil may produce serious errors in the measurement of earth resistance. To eliminate this, hand driven generator is used.
- (b) If the frequency of the supply of hand driven generator coincides with the frequency of stray current there will be wandering of instrument pointer. An increase or decrease of generator Speed will cause this to disappear.

**34.4.8.5.3** At the time of test, the test electrode shall be separated from the earthing system.

**34.4.8.5.4** The auxiliary electrode shall be of 13 mm. diameter mild steel rod driven up to 1 meter into the ground.

**34.4.8.5.5** All the three electrode shall be so placed that they will be independent of the resistance area of each other. If the test electrode is in the form of rod, pipe or plate, the auxiliary current electrode "C" shall be placed at least 30 meter away from it and the auxiliary potential electrode "B" shall be placed midway between them.

**34.4.8.5.6** Unless three consecutive readings of test electrode resistance agree the test shall be repeated by increasing the distance between electrodes A and C up to 50 metres and each time placing the electrode B midway between them.

**34.4.8.5.7** On these principles "Megger Earth Tester" containing a direct reading ohm-meter, a hand driven generator and auxiliary electrodes are manufactured for direct reading of earth resistance of electrodes.

**34.4.8.6** ***Furnishing of certificate:*** On completion of an electric installation (or an extension to an installation) a certificate shall be furnished by the agency executing the work countersigned by the Engineer-in Charge under whose direct supervision the installation was carried out. This certificate shall be in the prescribed form as given in appendix D in addition to the test certificate required by the M.P.E.B.

## **34.5 OVERLOAD LINE WORK :**

**34.5.1** Scope: This specification covers the requirement for the installation testing and commissioning of overhead distribution lines up to and including 11 K V. service connection and street lighting work and the materials used therein.

**34.5.2 Materials:****34.5.2.1 Supports:**

Supports for overhead lines and for street light shall be any of the following types or as specified by Engineer- In-Charge and shall be of adequate strength conforming in all respect to Rule 76 of Indian Electricity Rules.

(a) *Steel tubular poles:* This shall conform to I.S. 2713-1964. This shall be of seamless! swaged and welded type as specified and shall be in three stepped sections. Unless otherwise specified 1/6th of the length of the pole plus 15 cms. from its base shall be coated with black bituminous paint both internally and externally. The remaining portion of the pole shall be painted with one coat of red oxide on its external surface. The pole shall be complete with a cap and base plate.

(b) *Steel-rail poles:* This shall conform to standard specification of Indian Railway. Since the 22, 25 and 45 kg.( 40, 50 and 60 LBS.) rails do not have adequate strength in the longitudinal direction, longitudinal guys should be provided at every tenth pole in a straight run.

(c) *Cement concrete poles:* Reinforced cement concrete (RCC) and prestressed cement concrete (PCC) pole shall conform to-1.S. 785 - 1964 and I.S. 1678 1960 respectively and shall carry an earth bond in-accordance with Rule 90 of I.E. Rules. The dimensions shall be as per design conforming to the load requirement. Particulars of four typical designs of RCC poles are given in table-5.to this part. Concrete poles shall be treated with suitable chemicals like silicon for the portion to be buried in ground where the sub-soil water is high and acidic as in coastal areas.

(d) *Wood poles:* This shall conform to I.S. 876-" 1970 This shall be of teak ,sal or any other hard wood. The dimension shall be as per design conforming to load requirements. It shall be straight with a deviation tolerance of 5 cm. on the entire length of pole. The pole if tapered shall taper uniformly from bottom to top. The surface of the pole shall be smooth all knots being trimmed close. The pole shall be free from the saps or hollows, cross breaks, dead streaks and reasonably the from decay, split or checks hollow heart, rot ring sake, insect damage, knots, scars etc. The butt end of the pole shall be trimmed flat perpendicularly to its length. All wooden poles shall be properly treated with ASCU wood preservative or creosote. The standard pole can be made out of 18 SWG GI Sheet may be provided where so specified as a precaution against adverse weather.

(e) Galvanised Iron (G.I.) pipes mild steel pipes (both seamless or ERW) fabricated poles of structural steel and another special type of poles for garden light / low height street light may also be used.

**34.5.2.2 Line Materials:**

**34.5.2.2.1 Cross-Arms:** The following sizes of cross arms shall be used

(a) For 11 K.V. lines: V cross-arms of width 920 mm.(3 feet) between the V arms made of channel iron 75mm X 40 mm. (3 inches X 1.5 inches) 'X 5.7 kg. / meter.

(b) For low tension lines:

(i) For 3 phase 4 wire lines for aluminum conductors of size 3 of 7/3.4 mm. and I of 7/2. 79 mm.

Two numbers 75mm X 75mm 6mm.(3 inches X 3 inches X 1/4 inches) 610 mm. (2 feet) long angle iron single phase cross arms arranged one below the other for the dead ends and 65mm X 65mm X 6 mm.(2.5 inches X 2.5 inches X 1/4 inch) F220 mm.(4 feet) long angle iron cross-arm for pin points.

(ii) For single phase line for aluminum conductors of size up to 7/2.44 mm.:

75mm X 75mm. X 6mm.(3 inches X 3 inches X 1/4 inches) 610 mm.(2 feet) long angle iron for dead ends and 65mm X 65mm X 6 mm.(2.5 inches X 2.5 inches X 1/4 inch) 610 mm.(2 feet) long angle iron for pin points.

A Minimum distance of 8 cms for LV / MV lines and 10 cms. for HT lines shall be left from the centre of the extreme insulator pin holes to the end of cross—arm. The spacing of the pin holes shall be as per clearances specified in para 34.3.3.3. The cross-arm shall be complete with pole clamps made of M.S, flats of size not less than 50 nun. X 6mm. with necessary bolts, nuts and washers. The cross-arm shall have pin holes as required. Length of cross-arms for carrying guard wires shall be such that the guard wire shall always be not less than 30 mm. beyond the outer most conductor of same configuration.

**34..5.2.2..2 "D" Iron Clamp:** Where so specified in the contract, conduction, shall be spaced vertically supported on shackle insulators which are attached to the pole by means Of 'D" shaped clamps made of M. S. Bats of size not less than 50 mm. X 6 mm. and galvanised.The dimension of "D" iron clamp shall be such as to hold a 75 mm. high and 90 mm. dia. (minimum size) shackle insulator. The "D" iron clamp shall be complete with pole clamp with Necessary bolts, nuts and washers and insulator bolt pins.

**34.5.1.2.3** G.I. *Strap*: Where "D" iron clamps are not specified a pair of strap plates of galvanised iron of size 40 mm X 3 mm and length 23 cm. shall be used with shackle insulators.

**34-5..1.2.4.** The cross-arm and the pole clamp shall be treated with one coat of red oxide primer before erection and finished with two coats of approved paint after erection along with other hardware.

**34.5.1.3** *Stay: I Strut:*

**34.5.1.3.1** *Stay*: A Stay set shall consist of stay rod anchor plate, bow tightener or turned buckle thimbles, stay wire and strain insulator. The stay rod shall be with stay grip in case turn buckle is used instead of bow tightener. The entire stay assembly shall be galvanised. The stay wire shall be 7 / 3.15 mm. G.I generally conforming to LS. 2141-1968 grade 2 [specification for galvanised steel strand (fast revision) (with Amendments No, 1 and 2).] The anchor plate shall be of M.S. galvanized and not less than 30 cm. x 30 cm. x 6.4 mm. thick and the size of stay rod shall be not less than 1.8 m.(6, feet) long and 19 mm. dia.

**34.5..1.3.2** *STRUT*: A strut shall generally consist of a pole of the same section which it supports or slightly lighter.

**34.5.2.4** *Insulator*

**34.5.1.4.1** The porcelain insulator shall conform to IS.1445-1966[specification for porcelain insulators for over head power lines below 1000 Volts) (revised) (with amendment No.1)] Suitable for over head power line (below 1000 Volts)and I.S. 731-1971 [specification for porcelain insulators for over head power lines with a normal voltage greater than 1000 V. (second revision)] for over head power lines with a nominal voltage greater than 1000 V. This shall be vitreous through out and non, absorbant. The exposed surface shall be glazed. Insulator shall have adequate mechanical strength degree of resistance to electrical puncture and resistance to climatic and atmospheric attack.

**34.5.2.4.2** The insulator shall be of the following types.

- (a) Pin and shackle insulator LT. and M.V. lines. The neutral wire should be attached to G.I aluminum knobs.
- (b) Pin and disc type for H.V. lines.

**34.5.2.4.3**      The minimum size of shackle insulator shall be 90 mm. dia. by 75 mm.high

**34.5.2.4.4**                      The minimum size of pin insulator shall be 65 mm. dia. by 100 mm. high. The pin insulator shall be suitable for 12 mm cordean thread and shall be complete with G.I .pin, nuts and washers.

**34.5.2.5**                      **Conductors:**

**34.5.2.5.1**                      Conductors shall be any of the following types or as specified by the Engineer - in - Charge.

(a)      - All aluminum stranded: This shall comply with the requirements of I.S. 398 - 1961

(b)      Aluminum conductors steel reinforced: This shall comply with the requirements of IS. 398 - 1961

**34.5.2.5.2**                      **Choice of conductors:**      The physical and electrical properties of different conductors shall be in accordance with relevant Indian Standards. All conductors shall have a breaking strength of not less than 350 KG. Size of conductor in respect of current capacity may be access from table 6&7.

**34.5.2.5.3**                      No conductor of smaller cross - section than the following shall be used for distribution lines.

All aluminum stranded	A.C.S.R
7/1.96 mm.	6/ 2. 11 mm. plus 1/ 2.11 mm.

**34.5.2.6**                      **Binding material:**

**34.5.2.6.1**                      Binding of conductors with insulators shall be done with 12 SWG soft aluminum conductor.

**34.5.2.7**                      **Guard wire' :**

**34.5.2.7.1**                      **Guard wire shall be of G.I**

**34.5.2.7.2**                      It shall have minimum breaking strength of 635 kg. in accordance with Rule 88 of Indian Electricity Rule.

**34.5.2.7.3**                      It shall also be of sufficient current carrying capacity to ensure rendering the line dead without risk of fusing of guard line.



**34.5.2.8 Lightning Arresters:**

**34.5.2.8.1** These shall conform to I.S. 3070-1965 Part-I and I.S. 3070-1966 Part-II as applicable.

**34.5.2.8.2** *Horn gap type."*

This type of lightning arrester shall be used for L.T/M.V. lines wherever specified.

**34.5.2.8.3** *Surge Diverters:* Single pole unit enclosed in a G.I. case for outdoor mounting shall be used for system not exceeding 650 volts.

**34.5.2.8.4 Pellet Thyritie type surge Diverters."**

These types of surge diverters with standard rating of ]] KV shall be used for H. T. lines.

34.5.2.8.5 The lightning arrester system shall conform to Rule 92 of I.E. rules - See Appendix A.

**34.5.2.9 Paint:**

**34.5.2.9.1** Paints of approved quality and shade conforming to relevant Indian Standards shall be used.]

**34.5.2.9.2** Primer coats shall be with red oxide ready mixed and of approved manufacture.

**34.5.3. Routing:**

**34.5.3.1** **Route:** The route shall be adopted based on the following:

~

**34.5.3.1.1** As far as possible the route. of distribution line as well as the location of stay sets shall be decided taking into consideration the present and future requirements.

**34.5.3.1.2** The route of distribution lines shall generally follow the route of roads.

**34.5.3.1.3** Poles for distribution lines may be located along the side of the road, on the road bend a little away from road edge and drain.

**34.5.3.1.4** Normally there shall be ,a pole located at road junction.

**34.5.3.1.5** The route shall be chosen to avoid use of struts and continuous curve as far as possible.

**34.5.3.1.6** Junction of main road and service lane shall be preferred for location of pole so that the street light will benefit the service lane as well.

**34.5.3.1.7** Front of entrance to building shall be avoided for locating poles.

**34.5.3.2 Spacing of poles:**

**34.5.3.2.1 Rules.**

This shall be in accordance with Rule 85 of Indian Electricity

**34.5.3.2.2** When a LV /MY line runs close to a row of buildings the neutral conductor shall be situated at end nearest to the building of the cross arm.

**34.5.3.2.3** Where distribution line and street light fixtures are erected all the same support, the span shall normally exceed 45m.

**34.5.3.2.4** Span 'chosen shall be such that in a residential area adequate street lighting can be provided.

**34.5.3.3 Clearances:**

**34.5.3.3.1** The spacing of conductor shall comply with the requirements given below :

**Minimum clearance between conductors on the same support.**

(a) **L.T. Lines:**

(i) Vertical configuration of conductors:

Minimum clearance between earth and live Conductors. 30cm.

Minimum clearance between live conductors 20 cm.

(ii) Horizontal configuration of conductors:

Minimum clearance between live wires` 45 cm.

on either side of support

Minimum clearance between live wires 30 cm.

on the same side of support

**Minimum distance between the centre of insulator pin hole and end of cross-arm** 8 cm.

(b) **H.T. Lines (11 K V) :**

**Triangular configuration :**

**Minimum distance between the centre of insulator pin hole and end of cross - arm** 10cm

The conductors are erected in such a way that they form an equilateral pattern of side of 0.92 m. minimum the vertical clearance between top and bottom conductors being 76.25 cm. (2 feet and 6 inches).

**34.5.3.3.2** The minimum clearance of the lowest conductor above ground levels across a street, along a street and else where for different voltage systems shall be in accordance with Rule 77 of Indian Electricity Rules - see Appendix A.

**34.5.3.3.3** The minimum clearance of over- head lines and service lines for different voltage system from building shall be in accordance with Rules 79 & 80 of Indian Electricity Rules - see Appendix A.

**34.5.3.3.4** When conductors of different voltages are erected on the support, Rule 81 of Indian Electricity Rules shall be adhered to. The clearance between L T / MY and 11 KV lines shall be not less than 1m.

**34.5.3.3.5** A clearance of not less than the height of the tallest support may be maintained between the parallel over-head lines on different supports.

**34.5.3.3.6** When two over-head lines cross the crossing shall be made at right angles as far as possible. The vertical clearance between LV/MV lines and 11 KV lines shall not be less than 1. 25m.

**34.5.3.3.7** The minimum clearance between guard wires and LV/MV line shall be 10 cm. and between guard wire and 11 KV line shall be 30 cm.

**34.5.3.3.8** Rule 86 and 87 of Indian Electricity Rules shall be followed for clearance between power and telecommunication lines and shall not be less than 1.5 ill. for lines up to 11 KV.

#### **34.5.4 Excavation for Foundation**

##### **34.5.4.1 General:**

**34.5.4.1.1** After the location of supports / stays are pegged accurately, the excavation work shall be taken up.

**34.5.4.1.2** Every care shall be taken to see that the pits are not oversized while digging.

**34.5.4.1.3** Care shall be taken to see that the minimum amount of soil is distributed to take advantage of bearing value of virgin ground.

**34.5.4.1.4** The pit for support/stay strut shall be filled up or concreted only in presence of Engineer-in-charge.

**34.5.4.1.5** Suitable caution signs red lights and other protective measures as directed by the Engineer-in Charge, should be provided near the pit warning the pedestrians! vehicular traffic till such time the pit is back filled and surface leveled.

##### **34.5.4.2 Excavation for supports:**

**34.5.4.2.1** The depth of pit shall be such that normally 1/6 th of the length of pole is buried in the ground. The size of the pit shall be suitable for the foundation of the support as per clause 34.5.5.1

**34.5.4.2.2** The foundation pit shall be generally excavated in the direction of the lines.

**34.5.4.2.3** The position of pit shall normally be such that the stay makes as large as an angle as possible with the support. A good angle for the stay will be Within the range of 40 degrees to 60 degrees.

**34.5.4.2.3.1** The depth of the pit shall be such that normally a length of 45 mm. of stay rod shall project above the ground level. The size of the pit shall be suitable for the foundation of stay a~ per clause 345.5.2.

##### **34.5.4.4 Excavation for struts:**

**34.5.4.4.1** . The pit for strut shall be located at a distance not less than 1. 8m nom the pole.

**34.5.4.4.2** The depth of the pit shall be such that at least 1.2 m of the strut buried in the ground and the size of the pit shall be suitable for the foundation of the strut as per clause 34.5.5.2.11 .

**34.5.5 Erection:****34.5.5.1 Erection of supports:**

**34.5.5.1.1** All supports shall be correctly aligned before concreting or the bed filling of the pit with excavated earth.

'''

**34.5.5.1.2** All supports including RCC and PCC shall be erected over the cement concrete 1:3:6 (1 cement:3 coarse sand:6 graded stone aggregate of 40 mm. nominal size) bed of 15 cm. thick either cast *in situ* or precast and laid in excavated pit irrespective of the use of base plate. The area of this cement concrete bed shall be of 0.35 sq.m for steel tubular /steel rail and other steel poles or 0.5sq. m for RCC / PCC / Wood Poles.

**34.5.5.1.3** The support shall be erected in anyone of the following ways:

(a) Steel tubular / steel rail / other steel pole shall be fixed in cement concrete 1:3:6 (1 cement: 3 coarse sand:6 graded stone aggregate of 40 m nominal size) foundation with not less then 20 cm thick layer of cement concrete all around the support the foundation being continued up to 15 cm above ground level and tapered suitably in to a collar.

(b) RCC / PCC poles shall be erected using brick or stone ballast with excavated earth as binder which is well consolidated. The ramming shall be done in layers of 20cm Water as necessary shall be used during this operation. The sectional area of the consolidated ballast foundation shall be not less then 0.5 sq.m including the area occupied by support itself and shall be maintained up to the ground level.

RCC and PCC poles except where specified otherwise, do not require any setting in concrete. No cement concrete collar is also necessary for such type of poles.

( c ) *Wood poles*: - Wood poles shall be erected in any of the above methods as specified in the contract.

'''

**34.5.5.1.4** After concreting the excavated earth shall be back filled and well consolidated in layers of 20 cm

**34.5.5.1.5** Watering of concreted foundation above ground level and curing for at least two weeks shall be done by using moist gunny bags, etc., before loading the pole.

**34.5.5.2      *Erection of stay:***

**34.5.5.2.1**      A stay shall be provided at all angle or terminal pole.

**34.5.5.2.2**              The stay rod will be set in position in the excavated pit as shown in drawing No.1 0, figures 1,2 and 3.

**34.5.5.2.3**              Correct positioning and setting of stay set is essential. The stay rod with anchor plate shall be embedded in cement concrete 1:3:6 (1 cement :3 coarse sand:6 graded stone aggregate of 40 from. nominal size) not less than 0.28 cu.m in content in such a way that the top of the concrete block is well below the ground level to prevent uprooting of the stay rod as shown in plate 34-P/1 fig. 1. Alternatively the stay rod shall be embedded vertically in cement concrete 1:3:6 (1 cement :3, coarse sand:6 graded stone aggregate of 40 nun. nominal size) foundation 42 cm in section the anchor plate lying over 15 cm. thick cement concrete. The stay rod shall bent at unthreaded portion such that the stay wire at the bent portion of stay rod are in correct alignment. Care must be taken to avoid sharp bend or damage to galvanisation as shown in plate 34-P/2 fig. 2 & 3.

**34.5.5.2.4**              After concrete has set, back filling shall be done with excavated earth and ramming in layers of 20 cm. adding water as required.

**34.5.5.2.5**              The top surface of the concrete around the stay shall be cured by means of moist gunny bags, etc. for at least two weeks before loading the stay.

**34.5.5.2.6**              The stay clamps shall be located near about the center of gravity of the pull of the overhead conductors. The stay clamps shall be galvanised.

**34.5.5.2.7**              One end of the stay wire shall be fixed to the bow tightner or the stay grip of the stay rod and the other end to the stay clamp fixed to the pole by means of well spliced nuts using G.I. thimbles. A strain insulator shall be provided approximately at the middle of the stay wire. Turn buckle when used, shall be installed at the top of the stay wire.

**34.5.5.2.8**      The stay shall also be connected and bonded properly to earth.

**34.5.5.2.9**              Double stays shall be provided at all dead ends or at any other place as required by Engineer-In-Charge. In such cases these shall as far as possible, be set parallel to each other.

**34.5.5.2.10**              The stay rod where so specified in the contract shall be protected with G.I. pipe which shall not be less than 5 cm. diameter and 1. 5 meter long placed so as to be 0.6 meter below ground. The length of stay rod shall accordingly be increased.

**34.5.5.2.11** If the stay rod can not be erected in accordance with the above clauses due to roadways or obstructions, building etc. bow stay, fly stay or strut which ever is suitable to the location shall be used.

(a) Bow stay: Bow stay shall consist of a brace within pulley on the outer end to allow for free motion of stay wire in addition to other accessories required for the set as mentioned in 14.5.2.3.1. The stay Wire shall be clamped with the top of pole of the other end to a stay rod passing over the pulley of brace. The brace shall be clamped at 2/3rd height of the pole from the ground level. The stay rod shall be embedded in cement concrete foundation in the usual manner as near as possible to the pole.

(b) Fly stay: The fly stay shall consist of a fly pole wire running over the obstruction and usual stay alignment for the fly pole.

The stay wire crossing the obstruction shall be clamped at the one end to the top of the pole carrying conductors and on the other end to the top of the fly pole with a turn buckle. The fly stay shall be provided with a stay in the usual manner. The fly stay shall be taken at such a height as may be directed by the Engineer-In-Charge. When the fly stay is taken across a road it shall conform to traffic regulations.

(c) Strut: The strut shall be buried in the ground as mentioned in 34.5.4.4 and erected in the same manner as the support. It shall rest on the pole squarely and shall be firmly secured.

**34.5.5.3      *Erection of line material:***

**34.5.5.3.1**      Cross-arms: Cross-arms shall be clamped to the support properly taking into consideration the orientation of the lines.

**34.5.5.3.2      *"D" Iron Clamps:***

- (a) "D" iron clamps shall be used where vertical configuration of conductors is adopted.
- (b) "D" iron clamps shall be fixed to the support either by a through bolt and nut arrangement or by suitable pole clamp with bolt and nut.
- (c) These shall be installed vertically on the support complying with the vertical clearance required between the conductors indicated in 34.5.3.3.1.

**34.5.5.4 Erection of insulators :**

**34.5.5.4.1** Pin insulators / shackle insulators / disc insulators shall be created on the cross arms and "D" iron clamp as specified in the contract or as directed by the Engineer- In-Charge.

**34.5.5.4.2** Shackle insulators. shall be used in conjunction with "D" iron clamp when the configuration of conductors is vertical. These shall also be erected on cross arms at intermediate support in case of long lines; deviation from, straight line more than 30° terminal position, junction poles etc. (See also 34.5.2.4.3)

**34.5.5.4.3** Care shall be taken that insulators are not damaged during erection and damaged insulators are not used.

**34.5.5.5 *Stringing of conductors:***

**34.5.5.5.1 *Handling:***

- (a) The general precautions during storage and handling shall be taken in accordance with 34.6.5.1.
- (b) More attention is necessary during handling aluminum conductors because of their relative softness.
- (c) While paying off, the conductors shall be taken from the top of the drum and drum rotated in the direction of the arrow on it.
- (d) Care shall be taken during paying off to avoid contact with steel works, fence, etc. by giving soft wood protection using wooden rollers etc.

**34.5.5.5.2** Proper tools shall be used for stringing work.

**34.5.5.5.3** During stringing operation, standard sag tables or charts shall be followed.

**34.5.5.5.4** Care shall be taken to see that there are no kinks in the conductors.

**34.5.5.5.5** Joints in conductors shall be staggered. Mid span joints in conductors shall be generally avoided.



**34.5.5.5.6** After stringing the conductors it shall be clamped permanently with shackle or strain clamps. Angle or section points shall be selected while pulling up conductors. All strands of the conductors must be gripped securely when pulling the conductors.

**34.5.5.5.7** When the work is carried out adjacent to and for connecting to an existing system in operation or long parallelism to an existing line is involved adequate safety precautions for isolation, discharging, earthing etc., shall be taken to ensure that the lines do not inadvertently get charged from live supply. Where "Permit to work" system is in vogue, regular safety procedure prescribed should be complied with.

**34.5.5.6** ***Jumpers:***

**34.5.5.6.1** While stringing conductors of sufficient length be kept at shackle termination or making jumpers.

**34.5.5.6.2** Jumpers shall be neat and as far as possible symmetrical to the run of conductors. These shall be so made to prevent occurrence of fault due to wind or birds.

**34.5.5.6.3** When necessary jumpers shall be insulated conductors or insulated as directed by Engineer-In-Charge.

**34.5.5.6.4** Parallel groove(PG) clamp may be preferred to binding of conductors at jumper location or service taps.

**34.5.5.6.5** Jumpers used shall normally be of the same material as the line conductor and be of adequate current carrying capacity. If the material of the jumper wire is different from that of the conductor, suitable bimetallic clamps should be used. If copper to aluminum bimetallic clamps are to be used, it should be ensured that the aluminum conductor is situated above the copper conductor so that no copper contaminated water comes in contact with aluminum

'''

**34.5.5.6.6** For high voltage lines the jumper should be so arranged that there is a minimum clearance of 30 cm under maximum deflection condition due to wind between the live jumper and other metallic parts. This may involve erection of pin insulators specially for fixing the jumpers.

**34.5.5.7** ***Binding of conductors:***

**34.5.5.7.1** The binding of the conductor to the insulator shall be sufficiently Firm and tight to ensure that no intermittent contacts develop.

**34.5.5.7.2** The ends of binding wire shall be tightly twisted in a closely spaced spiral around the conductor to ensure good electrical contact and to strengthen the conductor.

**34.5.5.8** *Erection of guard:*

**34.5.5.8.1** At all road crossings, crossing of overhead lines, crossing with other line and between HV and LV / MY line carried on the same support, guard shall be provided(See plate 34-P/2 for guarding arrangement)

**34.5.5.8.2** The guard wires shall be bonded to earth.

**34.5.5.8.3** The guard wire shall run so as to have minimum clearance as indicated in clause 34.5.3.3.7.

**34.5.5.8.4** Cage guard shall be provided for distribution lines of vertical configuration.

**34.5.5.8.5** Cradle guard shall be used for distribution lines of horizontal configuration.

**34.5.5.8.6** In case of cradle / cage guards, at least 9 laces shall be provided for each span.

**34.5.5.9** *Cutting of trees etc.:*

**34.5.5.9.1** Construction of over head line may include cutting branches of trees or clearing of other obstructions that may come in the way of overhead lines but this must be done with the approval of Engineer- In-Charge.

**34.5.5.10** *Earthing:*

**34.5.5.10.1** Earthing installation shall conform to various 'clauses under . para 34.4.6

**34.5.5.10.2** All metal supports and all reinforced and prestressed cement concrete supports of overhead lines and metallic fittings attached there to shall be permanently and efficiently earthed. In the case of wood JRCC/PCC poles, all insulator pins, cross-arms, stays street light brackets and other metallic fittings shall be bonded to the earth lead.

**34.5.5.10.3** Junctions end terminal locations and all special structures may be selected for connecting to earth.

**34.5.5.10.4** The lead from earth electrode shall be suitably protected by a 15 mm. dia G.I. pipe up to a height of 3 m. from ground level.

**34.5.5.10.5** The protection pipe and the earth lead shall be suitably clamped to the support.

**34.5.5.11 Safety and protective device :**

**34.5.5.11.1** *Danger Board* - All supports carrying HV lines shall be fitted with danger plates conforming to I.S. 2551-1963 at height of 3m. from the ground indicating the voltage of the line.

**34.5.5.11.2** *Anti climbing device,"*- Necessary arrangement for preventing unauthorized persons from ascending any of the supports carrying HV lines, without the aid of a ladder or special appliances, shall be made as directed by the Engineer-In-Charge. Unless where otherwise specified, barbed wire conforming to IS 2784-1969 having four point barbs spaced  $75 \pm 12$ mm.apart and weighing 108/125 gm. /m. shall be wrapped helically with a pitch of 75 cm. around the limb of the support and tied firmly commencing from height of 3.5 m. and up to a height 5 or 6 m. as directed by Engineer- In-Charge.

**34.5.5.11.3 Lightning arresters:**

- (a) Horn gap type lighting arrestors for LV/MV and surge diverter suitable for MV lines shall be employed with each phase at terminal and other places where specified depending upon local climatic condition and mounted on poles or a cross-arms as directed by Engineer-In-Charge.
- (b) In the case of Horn gap type arrester, a short and definite air gap must be maintained between the horns. This gap shall not exceed 2 cm.
- (c) Pellet or Thyrite type lighting arrester suitable for H. T lines shall be installed one unit per phase at the terminations, transformers' stations, etc. as directed by Engineer-In-Charge.
- (d) These devices shall be conducted ahead of fuses if any, provided.
- (e) Independent earth electrode shall be provided for lightning arresters.

- (f) The earth lead from the earth electrode to the lightning arrester shall be continuous and if desired insulated throughout above earth surface by alkathene pipe.

**34.5.6 Service entry and service fuses:**

**34.5.6.1** No service connection shall be taken on an over- head line except at a point of support.

**34.5.6.2** The service line shall be guarded wherever required in accordance with I.E. Rules 1956.

**34.5.6.3** Service connection shall be either through an overhead service or underground cable as specified. In case of overhead service the same should be provided either with :

- (a) Bare conductor or
- (b) Insulated conductor

**34.5.6.3.1** Service connection with bare conductor: Any of the following methods shall be adopted as specified:

(a) The bare conductors shall be strung with shackle insulators fixed to cross-arms on both ends. The feeding end cross-arms shall be fixed to the support and the one of the receiving end, shall be mounted on G.I. pipe of minimum dia. 5cm. The bare conductors shall be kept at a height of at least 2. Sm. on the top of the structure in accordance with Rule 79 of I.E. Rules.

(b) The G.I. pipe shall be provided with double bends at the top. The pipe shall be secured by at least 2 clamps mad~ of 50mm X 6mm. M.S. flats fixed firmly to the wall in the vertical position. It shall in addition be provided with a G. I. stay wire of 7/3.15 mm. size anchored to the building with one eye bolt. Service connection given with weather proof / PVC insulated bushes shall be provided at both ends of this G. I. pipe.

The bare conductors shall be strung with shackle insulators as above except at the receiving end where the insulator shall be fixed to a square or a rectangular wall bracket made of angle iron of size not less than 50 mm. X 50mm. X 6mm. The ends of the bracket shall bend and split and embedded in the wall with cement mortar. The bare conductor shall be kept atleast 1.2 m.

away from the edge of the structure, in accordance with Rule 79 I.E. Rules. The service connection shall be given with weather proof / PVC insulated cable to G.I. pipe of minimum dia. 4 cm fixed to the wall. The G.I. pipe shall be bend downward near the service entry. Well fitted wooden / PVC bushes shall be provided at the both ends of the G.I. pipes.

**34.5.6.3.2** Service connection with insulated conductors: Service connection may be given by weather proof / PVC insulated cables on G.I. bearer wire. The bearer wire should be stranded 7/20 G.I. or near above size. The bearer wires and weather proof cables should be bunched together by porcelain reel insulators or alkathene clips at intervals of 10 cm One end of the G.I. bearer wire shall be attached to a clamp which is fastened to the nearest pole carrying distribution lines from where the service connection is intended to be given. The other end of the G I. bearer wire shall be fastened to 5 cm dia. G.I. pipe(for a span up to 4.5m.) which is fixed to the wall with guy etc. The G.I. pipe shall be fixed to an angle iron of size 38 mm. X 38mm X 6.4 mm with suitable guy for high support and for span exceeding 4.5m Alternatively, when the height of the structure permits minimum ground clearance the other end of this G.I. bearer wire may be fixed to a hook eye-bolt or bracket embedded with cement mortar in the wall. The weather proof / PVC insulated cable shall pass through G.I. pipe of minimum dia. 5 cm which is bent downwards. Wall fitting wooden / PVC bushes shall be provided at both ends of the G.I. pipe. The bearer wire should not be used as earth lead. The bearer wire should be earthed at both pole ends and at the building end to the building earth.

".

**34.5.6.3.3** Service connection by under ground cable: The service cable from an overhead distribution line shall be fixed to the support with 2 Nos. of clamp of M. S flat of size 50 mm X 6 mm This shall be protected up to a height of 3 mm from he ground level by a G.I. pipe of adequate strength clamped to the support of 2 Nos. of M. S. flat of size 50 mm X 6 mm The cable shall be laid through pipe while crossing the roads, pavements, masonry etc. The cable work shall be done in accordance with 34.6. The cable entry into building shall be in accordance with clause 34.6.6.6.6 and 34.6.6.6.7. The service cable shall be terminated to an outdoor cable termination box fixed to the support. The connection shall be given either by the core of the service cable directly or through separate insulated leads.

**34.5.6.4** **Service fuse:** Service fuses carriers shall be of approved make and of ample size to permit entry of ends of service lines connected to them They shall be fixed at the distribution line support from which the service line is tapped. Approximate size off use elements should be 'as per table-3\*\*'.

**34.5.7 Numbering Supports:**

**34.5.7.1** All supports shall be numbered as directed by the Engineer-in-Charge

**34.7.2** Separate number plates may be used if so specified.

**34.5.8** Painting and repainting of-supports, cross-arms etc.:

**34.5.8.1** Treatment of all supports and line materials before or at the time of erection shall be done in accordance with the relevant sub para 34.5.2.

**34.5.8.2** After erection, the external surface of main support above ground level and all pipe fittings shall be painted as directed by the Engineer-In-Charge.

...

**34.5.8.3** The following procedure for painting / repainting shall be adopted.

**34.5.8.3.1** Preparation of the surface: All rust and scales shall be removed by scrapping or by brushing with steel wire brushes. All dust and dirt shall be carefully and thoroughly wiped away. Painting shall not be done when the surface is wet.

**34.5.8.3.2** Primer coat shall be applied with red oxide paint.

**34.5.8.3.3** When the primer coat has dried up and before any moisture, dirt, dust etc. settle down on the surface, the paint of desired shade shall be applied. Application shall be done with brushes and the paint shall be spread as evenly and smooth as possible. The surface shall be given two or more coats as directed and shall finally present a uniform appearance and glassy texture.

**34.5.9 Testing Of Overhead Line:**

**34.5.9.1** Before connecting the services to the transformer, equipment etc., a pressure test of appropriate standard shall be carried out on the line, as directed by Engineer- In-Charge.

~

**34.5.9.2** Before charging the M.V. lines, the same shall be tested with a 500 V. megger for insulation.

**34.5.9.3** Where pressure test is not done on H V. lines it shall be tested With a 2500 V / 5000 V megger for insulation before charging.

**34.5.10 Commissioning:**

**34.5.10.1** The distribution lines shall be charged only if the pressure / megger test is satisfactory.

**34.5.10.2 .** The lines shall be commissioned in the presence of Engineer-In-Charge

**34.5.11.1** For all works costing more than Rs. 10,000 completion certificate after completion of work as given in the Appendix-E shall be submitted to the Engineer-In-Charge. Completion plan drawn to a suitable scale in tracing cloth with ink indicating the following along with three blue print copies of the same shall also be submitted.

- (a) Central layout of overhead lines.
- (b) Location of each support, stay, strut length of each span, number of spans provided with cradle guard, guard earth, number and size of each line conductor, joints in conductors, size of earth continuity wire, lightning protective devices, service bracket / entry, fuses etc.
- (c) For the cable work done, if any, layout of power cable, size and number of cores, type and length.
- (d) Details of voltage and system of supply, height of support, configuration, spacing of conductors, average sag, total route length, scale of drawing etc. in a tabular form
- (e) Name of work, job number, accepted tender reference, date of completion, names of division / sub-division, names of contractors with their signatures.

**34.5.11.2** In the case of works costing less than Rs. 10,000.00 the completion plan shall be prepared by the department and signed by the contractor before final payment is made.

**34.5.11.3** Whenever additions and alterations into existing installations are carried out, the plans showing the layout of distribution system shall be modified and brought up to date.

**34.6 CABLE WORK :**

**34.6.1** This specification covers the requirement for the selection and installation of Power cables for low, medium and high voltage applications.

**34.6.2 Types Of Cables:**

**34.6.2.1** The cables for application for low and medium supply shall be PVC insulated and PVC sheathed conforming to I.S. 1554 part-I 1964.

**34.6.2.2** The cables for applications above 1.1 KV but up to and including 11 KV supply shall be either PVC insulated and PVC sheathed, conforming to I.S. 1554 part-II 1970 or paper insulated sheathed conforming to I.S. 692-1973.

**34.6.2.3.** The cables shall have solid / stranded aluminum conductors.

**34.6.2.4** Where paper insulated cables are used, in predominantly vertical situation, these shall be of non-drawing type.

**34.6.3 Armouring And Servicing:**

**34.6.3.1** Short runs of cables laid in pipe, closed masonry trenches and similar protected / secured enclosures need not be armoured PVC cables, when armoured, shall have galvanised steel wire (flat or round) for armouring. Paper insulated cables shall have for armouring, double layer of steel tape for normal applications. Steel wire armouring is preferred, where the cable is liable for tensile stresses in applications such as vertical runs suspended on brackets or land in fail i.e. likely to subside.

**34.6.3.2** Serving over armouring in paper insulated cables shall consist of a complete layer or layers of suitable compounded Hessian materials.

**34.6.4 Section Of Cables:**

**34.6.4.1** Cable sizes shall be selected considering the current carrying capacity, voltage drop, maximum short circuit duty and the period of short circuit to meet the present and future anticipated loads.

**34.6.4.2** Guidance for the selection of cables shall be derived from the relevant Indian standards such as I.S. 3961 (Part-I) 1967.

**34.6.4.3** While deciding cable sizes, derating factor for type and depth of laying, grouping, ambient temperature, ground temperature and soil resistivity shall be taken into account. In this connection, See table G. 7 to G. 14 of Appendix-G.

**34.6.5. Storage And Handling:**

**34.6.5.1** Cable drums shall be stored on a well drained, hard surface, preferably of concrete, so that the drums do not sink in the ground causing rot and damage to the cable drums.

...



**34.6.5.2** During storage periodical rolling of drums once in three months through 90 degree shall be done especially in the case of paper insulated cables. Rolling shall be done in the direction of the arrow marked on the drum.

**34.6.5.3** It should be ensured that both ends of the cables are properly sealed to prevent ingress / absorption of moisture by the insulation.

**34.6.5.4** Protection from rain and sun is preferable. Sufficient ventilation between cable drums should be ensured during storage.

**34.6.5.5** The drums shall always be rested on the flanged end not on the flat

**34.6.5.6** Damaged battens of drums, should be replaced if necessary.

**34.6.5.7** When cable drums have to be moved over short distances, they should be rolled in the direction of the arrows marked on the drums.

**34.6.5.8** For transportation over long distances, the drum should be mounted on the cable drum wheels strong enough to carry the weight of the drum and pulled by means of ropes. Alternatively, they may be mounted on a trailer or on a suitable mechanical transport.

**34.6.5.9** While unloading cable drums from vehicles, a crane shall preferably be used. Otherwise the drum shall be rolled down carefully on a suitable ramp or rails, where necessary.

**34.6.5.10** While removing cables the drums shall be properly mounted on **jacks or on a cable wheel or any other suitable means making sure the spindle jack etc. strong enough to take the weight of the drum.**

**34.6.5.11** While transferring cable from one drum to another, the barrel of the new drum shall have a diameter not less than that of the original drum.

**34.6.5.12** The cable shall not be bent sharp to a small radius. The minimum safe bending radius for all types of PVC cables shall be taken as 12 times the overall diameter of the cable. The minimum safe bending radius for paper-insulated cables shall be as follows. Wherever practicable, large radius should be adopted. At joints and terminations, the bending radius of individual cores of a multi core cable shall not be less than 15 times its overall diameter.

TABLE .. I (34.6.5.12)

**Minimum Bending Radius -Paper Insulated Cables**

System Voltage	Minimum bending radius		
	Single core	Unarmoured	Multi core Armoured
Up to & including 11 KV	20 D	15 D	12 D

Where "D" is the over all diameter or the cable .

**34.6.5.13** Cables with kinks and straightened kinks Of with similar apparent defects like defective armoring, etc, shall not be installed.

**34.6.6 Installation :**

**34.6.6.1** *General:* The cable installation including necessary joints shall be carried out in accordance with the specifications given btfeln, For details not covered in these, specifications I. S. 1255-1967 shall be followed.

**34.6.6.2 Route:**

34.6.6.2.1 Before the cable laying work is under taken the route of the cable shall be decided by the Engineer-In-Charge.

**34.6.6.2.2** While shortest practicable route should be preferred, cable runs shall generally follow fixed developments such as roads, foot-paths etc. with proper offsets so that the future maintenance identification etc. are rendered easy. Cross country run to shorten the route length is not desirable as it would be set with route identification and maintenance problems besides posing difficulties during later development of open areas etc.

**34.6.6.2.3** While selecting cable routes, corrosive soils, ground surrounding sewage effluent etc., shall be avoided; where this is not feasible, special precaution as decided by the Engineer-In-Charge, particularly for HV cable installation shall be taken.

**34.6.6.2.4** As far as possible, the alignment of the cable route should be decided taking into consideration the present and future requirements of other agencies and utility services affected by it the existence of any cable in the vicinity as may be

indicated by cable markers or cable schedule or drawings maintained for that area~ possibilities of widening of roads / lanes, storm water drains etc. Cable route shall be planned away from the drains and near the property, especially in the case of MV / LV cables subject to any special local requirements that may have to be necessarily complied with.

**34.6.6.2.5** Whenever cables are laid along well demarcated or established roads, the L VIMV cables shall be laid further from the kerb line than HV cables.

**34.6.6.2.6** Cables of different voltages and also power and control cables should be kept in different trenches with adequate separation. Where available space is restricted, LV /MV cables shall be laid above HV cables.

Where cables cross one another, the cable of higher voltage shall be laid at a lower level than the cable of lower voltage.

**34.6.6.3** *Proximity to communication cable:*

**34.6.6.3.1** Power and communication cables shall as far as possible cross at right angles. Where power cables are laid in proximity to communication cables the horizontal and vertical clearances shall not normally be less than 60 cms

**34.6.6.4** *Laying methods:*

**34.6.6.4.1** Cables shall be laid direct in ground in pipes, dosed ducts, in open ducts or on surface depending on environmental conditions.

**34.6.6.4.2** During the preliminary stages of laying the cable consideration should be given to proper location of the joint position so that when the cable is actually laid the joints are made in the most suitable places. As far as possible water logged locations, carnage ways, pavements, proximity places, ducts, pipes, racks etc., shall be avoided for joint position.

**34.6.6.5** *Laying direct in ground :*

**34.6.6.5.1** *General:* This method shall be adopted where no frequent excavations are encountered the cable route is through open country, along roads/lanes and where re-excavation is easily possible without affecting other services.

**34.6.6.5.2 Trenching:**

(a) Width of trench: The width of trench shall first be determined on the following basis :

(i) The minimum width of trench for laying single cable shall be 35 cm

(ii) Where more than one cable is to be laid in the same trench in horizontal formation, the width of trench shall be increased such that the inter-axial spacing between the cables, except where otherwise specified shall be at least 30 cm

(iii) There shall be a clearance of at least 15 cm. between axis of the end cables and the sides of the trench.

(b) *Depth of trench* : The depth of trench shall be determined on the following basis.

(i) Where cables are laid in single tier formation the total depth of trench shall not be less than 46 cm for cables up to 11 KV and 1.0 m. for cables above 11 KV.

(ii) When more than one tier of cables is unavoidable and vertical formation of laying is adopted, depth of trench in b(ii) above shall be increased by 30 cm. for each additional tier to be formed.

(c) *Excavation of trenches:* (i) The trenches shall be excavated in reasonably straight lines. Wherever there is a change in direction, suitable curvature shall be provided complying with the requirements of 34.6.5.12.

(iii) Where gradients and changes in depth are unavoidable these shall be gradual.

Excavation should be done by any suitable means-manual or mechanical. The excavated soil shall be stacked firmly by the side of the trench such that it may not fall back into the trench.

(iv) Adequate precautions should be taken not to damage any existing cable(s) pipes or other such installations in the proposed route during excavation. Wherever brick tiles or protective covers of bare cables are encountered, further excavation shall not be carried out without the approval of the Engineer-In-Charge.

"

(v) Existing property exposed during trenching shall be temporarily supported or propped adequately as directed by the Engineer-In-Charge. The trenching in such cases shall be done in short length, necessary pipes laid for passing cables therein and the trench refilled in accordance with 34.6.6.5.4.

(vi) If there is any danger of a trench collapsing or endangering adjacent structures the sides should be well shored up with timbering and / or sheeting as the excavation proceeds. Where necessary these may even be left in place when back filling the trench.

(vii) Excavation through lawns shall be done in consultation with the staff of the department/owner concerned.

(viii) The bottom of the trench shall be in level and need not be stone brick bats etc. The trench shall then be provided with a layer of clean dry sand cushion of not less than 8 cm. in depth.

**34.6.6.5.3                      *Laying of cable in trench:***

(a) At the time of issue of cable for laying the cores shall be tested for continuity and insulation resistance (refer para 34.6.8.)

(b) The cable drum shall be properly mounted on jacks or on a cable wheel at a suitable location making sure that the spindle jack etc are strong enough to carry the weight of the drum without failure and that the spindle is horizontal in the bearings so as to prevent the drum creeping to one side while rotating.

(c) The cable shall be pulled over rollers in the trench steadily and uniformly without jerks and strains. The entire cable length shall as far as possible be laid off in one stretch. However where this is not possible the remainder of the cable may be removed by 'Flaking' i. e. by making one long loop in the reverse direction.

(d) (i) After the cable has been uncoiled and laid in to the trench over the rollers the cable shall be lifted slightly over the rollers beginning from one end by helpers standing about 10m apart and drawn straight. The cable should then be taken off the rollers by additional helpers lifting the cable and then laid in a reasonable straight line.

(ii) For short runs and sizes up to 50 Sq. meter of cables up to 1.1 KV grade any other suitable method of direct handling and laying can be adopted with the prior approval of the Engineer-In- Charge.

(e) When the cable has been properly straightened the cores are tested for continuity and insulation resistance (Refer 34.6.8) and the cable is then measured. The ends of all lead sheathed cables' shall be sealed with solder immediately. In case of PVC cables suitable moisture tape shall be used for this purpose.

(f) (i) Cable laid in trenches in a single tier formation shall have a covering of clean dry sand of not less than 17 cms. above the basic cushion of sand before the protective cover is laid.

(ii) In the case of vertical multi-tier formation after the first cable has been laid a sand cushion of 30 cms. shall be provided over the initial bed before the second tier is laid. If additional tiers are formed each of the subsequent tiers also shall have a sand cushion of 30 cms. as stated above. The top most cable shall have a final sand covering not less than 17 cms. before the protective cover is laid.

(g) At the time of original installation approximately 3m. of surplus cable shall be left on each end of the cable and on each side of underground joints (straight through/Tee/Termination) and at entries and places as may be decided by the Engineer-in-Charge. The surplus cables shall be left in the form of a loop. Where there are long runs of cable lengths, loose cable may be left at suitable intervals as specified by the Engineer-in-Charge.

(h) A final protection to cables shall be laid as described below to provide warning to future excavators of the presence of the cable and also to protect the cable against accidental mechanical damage by pick-axe blows, etc.

"  
...

The cables shall be protected by second class bricks of not less than 20 cm. by 10 cm. (nominal size)(bricks to be laid breadth wise) or protection covers of RCC slabs placed on top of the sand for the full length of the cable to the satisfaction of the Engineer-in-Charge. Where more than one cable is to be laid in the same trench this protective covering shall cover all the cables and project at least 5cm. over the side of the end cables.

**34.6.6.5.4. Backfilling:**

(a) The trenches shall be then back-filled with excavated earth free from stones or other sharp edged debris and shall be rammed and watered if necessary in successive layers not exceeding 30 cm. Unless otherwise specified, a crown of earth not less than 5cm. in the centre and tapering towards the sides of the trench shall be left to allow for subsidence. The crown of earth however should not exceed 10 cms. so as not to be a hazard to vehicular traffic. The temporary re-instatements of roadways should be inspected at regular intervals particularly during the wet weather and any settlement should be made good by further filling as may be required. After the subsidence has ceased trenches not through roadways or other paved areas shall be restored to the same density and material as the surrounding area and repaved to the satisfaction of the Engineer-In-Charge.

(b) Where road berms or lawns have been cut or kerb stones displaced the same shall be repaired and made good except turfing/asphalting to the satisfaction of the Engineer-In-Charge and surplus earth or rock removed to places as specified.

**Route makers:** (a) Route makers shall be provided along straight runs of the cables at locations approved by the Engineer-In-Charge and generally at intervals not exceeding 100 m. Markers shall also be provided to identify change in the direction of the cable route and also for location of every underground joint.

(b) Route makers shall be made out of 100 mm. x 100 mm. x 5 mm. G.I. aluminum plate welded or bolted on to 35 mm. by 35 mm. by 6 mm. angle iron 60 cm. long. Such plate makers shall be mounted parallel to and 0.5 m. or so, away from the edge of the trench.

Alternatively cement concrete 1:2:4 (1 cement: 2 coarse sand: 4 graded stone aggregate of 20 mm. nominal size) 60 cm. x 60 cm. x 10 cm in size shall be laid flat and centered over the cable. The concrete markers unless otherwise instructed by the Engineer-In-Charge shall project over the surrounding surface so as to make the cable route easily identifiable.

(c) The word 'cable' and other details such as voltage grading size etc., as furnished by the Engineer-In-Charge shall be inscribed on the marker.

34.6.6.6 *Laying in pipes / closed ducts:*

- 34.6.6.6.1 In location such as road crossing entry to building on poles in paved areas etc. cables shall be laid in pipes or closed ducts.
- 34.6.6.6.2 Stone ware pipes, G.I., or spun reinforced concrete pipes shall be used for such purposes. In the case of new construction pipes as required shall be laid along with the Civil works and jointed according to the instructions of the Engineer-In-Charge. The size of the pipe shall be decided by the Engineer-In-Charge and shall not be less than 10 cm in diameter for single cable and not less than 15. cm. for more than one cable. These pipes shall be laid directly in ground without any special bed except for stone ware pipe which shall be laid over 10 cm thick cement aggregate 1: 5: 10 (1 cement: 5 coarse sand: 10 graded stones aggregate of 40 ,mm normal size) bed. No. sand cushioning or tiles need be used in such situations. Unless otherwise specified, the top surface of pipes shall be at a minimum depth of 1 m from the ground level when laid under roads, pavements etc.
- 34.6.6.6.3 The pipes on road crossing shall preferably be on the skew to reduce the angle of bend as the cable enters and levels the crossing. This is particularly important for high voltage cables.
- 34.6.6.6.4 Manholes of adequate size as decided by the Engineer-In-Charge shall be provided to ,facilitate feeding/drawing in of cables and to provide working space for persons. They shall be covered by suitable manhole covers with frame of proper design.
- 34.6.6.6.5 Pipes shall be continuous and clear of debris or concrete before cable is drawn. Sharp edges at ends shall be smoothed to prevent injury to cable insulation or sheathing.
- 34.6.6.6.6 Pipes for cable entries to the building shall slope downwards from the building and suitably sealed to prevent entry of water inside the building. Further the mouth of the pipe at the building shall be suitably sealed to avoid entry of water.
- 34.6.6.6.7 All chases and passages necessary for the laying of service cable connection to building shall be cut as required and made good to the original finish and to the satisfaction of the Engineer-In-Charge.
- 34.6.6.6.8 Cable grips / draw wires and winches etc. may be employed for drawing cables through pipes / closed ducts etc.



34.6.6.7 *Laying in open ducts:*

34.6.6.7.1 Open ducts with suitable removable covers shall be preferred in sub-stations, switch rooms, plant rooms, work-shop etc.

34.6.6.7.2 The cable ducts should be of suitable dimensions so that the cable can be conveniently laid. If necessary cables may be fixed with clamps on the walls of the duct or taken in troughs in duct. The duct should be covered with removable slabs or chequered plates.

34.6.6.7.3 Ducts may be filled with dry sand after the cable is laid and covered as above or finished with cement plaster specially in high voltage applications.

34.6.6.7.4 Slices or joints of any type shall not be permitted inside the ducts.

34.6.6.7.5 As far as possible laying of cables with different voltage ratings in the same duct shall be avoided.

34.6.6.7.6 Where considered necessary, hooks or racks shall be provided for supporting the cables in masonry / concrete cable ducts, cable troughs. Otherwise cable shall be laid direct in the trench or trough etc. While deciding the layout of cables in such ducts care should be exercised to ensure that unnecessary crossing of cable is avoided.

34.6.6.8 *laying on surface:*

34.6.6.8.1 This method may be adopted in places like switching stations, factories, tunnels, rising mains in buildings through special packages etc. The materials used shall be as approved by Engineer-In-Charge.

"

34.6.6.8.2 The cables may be laid in troughs or brackets at regular intervals or directly cleated to wall / ceiling. When laid over bracket supports, the cables shall be clamped to prevent undue sag.

34.6.6.8.3 Cable clamps shall be made from materials such as mild steel, porcelain, wood, aluminum, etc. In case of single core cables the clamps shall be of non-magnetic material. A suitable non-corrosive packing shall be used for clamping unarmoured cables to prevent damage to the cable sheaths.

34.6.6.9 *Cable identification tags:* Wherever more than one cable is laid / run side by side marker tags as approved inscribed with cable identification details shall be permanently attached to all the cables in the manholes / pull pits / joint pits / entry points in buildings / open ducts, etc. These shall also be attached to various cables

""

laid direct in ground at suitable intervals as decided by the Engineer-In-Charge before the trenches are filled up.

- 34.6.7 Jointing:
- 34.6.7.1 Jointing work shall be carried out only by a licensed experienced cable jointer.
- 34.6.7.2 At the preliminary stages of laying a cable at proper jointing position should be selected in accordance with 34.6.6.4.2.
- 34.6.7.3 Sufficient surplus cable shall be left on each side of joints as mentioned in 34.6.6.5.3.
- 34.6.7.4 Joints shall be staggered by 2 to 3 metre when two or more cables are laid together in the same trench.
- 34.6.7.5 A caution board indicating Caution - cable jointing work is in progress shall be displayed to warn the public and traffic where necessary.
- 34.6.7.6 Jointing pits shall be of sufficient dimensions as to allow easy and comfortable working. The sides of the pit shall be well protected from loose earth falling in to it. It shall also be covered by a tarpaulin to prevent dust and other foreign matter being blown on the exposed joint and jointing materials.
- 34.6.7.7 Sufficient ventilation shall be provided during jointing operation in order to disperse fumes given out by fluxing.
- 34.6.7.8 Jointing materials and accessories like conductor ferrules, solder, flux, insulating and protective tps filling compound jointing boxes, etc., of right quality and correct sizes conforming to relevant Indian Standards wherever they exist shall be used. The design of the joint box and the compositions of the filling compound shall be such as to provide as effective sealing against entry of moisture in addition to affording proper electrical characteristic to joints. Where special type of splicing connector lcits or epoxy resin spliced joints are specified materials approved for such application shall be used and instructions of the manufacturer / supplier of such material shall be strictly followed. .
- 34.6.7.9 Insulation resistance of cables to be jointed shall be measured with 500 V. megger up to 1.1 KV grade and with 2500 /5000 V. megger for cables of higher voltages. Unless the insulation resistance values are satisfactory jointing shall not be done.

- 34.6.7.10 Before jointing is commenced all safety precautions like isolation discharging earthing, etc., shall be taken to ensure that the cable would not be inadvertently charged from live supply. Metallic armour and external metallic bending shall be connected to earth. Where "permit to work" system is in vogue safety procedures prescribed in I.S. 5216-1969 shall be complied with- vide Appendix D.
- 34.6.7.11 Cores of the cables must be properly identified before jointing.
- 34.6.7.12 Whenever aluminium conductor is exposed to outside atmosphere a highly tenacious oxide film is formed which makes the soldering of aluminium conductor difficult. The oxide film should be removed using appropriate type of flux.
- 34.6.7.13 The clamps for the armour shall be cleaned and tight.
- 34.6.7.14 Where a cable is to be jointed with the existing cable the sequence should be so arranged as to avoid crossing of cores while jointing.
- 34.6.7.15 *Jointing procedure:*
- 34.6.7.15.1 While it would be best to follow strictly the instructions for jointing furnished by the manufacturers! suppliers of cable and joint boxes a brief on the jointing procedures for paper insulated and PVC cables is given for general guidance in Appendix H.
- 34.6.7.15.2 All indoor and outdoor jointing of paper insulated cable shall be done in accordance with the provision of section 11 of I.S. 1255-1967.
- 34.6.7.15.3 All outdoor jointing of PVC cable shall be done using best quality of compound and joining materials. For indoor termination of PVC cables joints with compression type glands shall be preferred.
- 34.6.8 Testing:
- 34.6.8.1 All cables before laying shall be tested with a 500 V. megger for 1.1 KV grade or with 2500/5000 V. megger for cables of higher voltages. The cable cores shall be tested for continuity or absence of cross phasing insulation resistance to earth / sheaths / armour and insulation resistance between conductors.
- 34.6.8.2 All cables shall be subjected to above mentioned tests during laying before covering the cables by protective covers and back filling and also before the jointing operations.

- 34.6.8.3 After laying and jointing, the cable shall be tested for one minute with 1000 V. megger for cables of 1.1 KV grade and with 2500 / 5000 V. megger for cables of higher voltages.
- 34.6.9 Completion Plan And Completion Certificate:
- 34.6.9.1 The work shall be carried out in accordance with the drawings enclosed with the tender and also in accordance with the modifications thereto from time to time approved by the Engineer-In-Charge.
- 34.6.9.2 For all works costing more than Rs.10,000, completion certificate after completion of work as given in Appendix E shall be submitted to the Engineer- In-Charge. Completion plan drawn to a suitable scale in tracing cloth with ink indicating the following along with three blue print copies of the same shall also be submitted. .
- (a) Layout of cable work.
  - (b) Length, size, type and grade of cables.
  - (c) Method of laying, i.e., direct in ground, in pipes, etc.
  - (d) Location of each joint with jointing method followed.
  - (e) Route marker and joint marker with respect to permanent land marks available at site.
  - (f) Name of work, job number, accepted tender reference, date of completion, names of division and sub division, names of contractor with their signature and scale of drawing.
- 34.6.9.3 In the case of work costing less than Rs.10,000, the completion plan shall be prepared by the department and signed by contractor before final payment is made.
- 34.6.9.4 Wherever the previously laid cable is cut and additional joints etc. are introduced, the cable records shall suitably be amended.

APPENDIX - A  
Extracts from Indian Electricity Rules 1956  
(As amended)

**CHAPTER IV • GENERAL SAFETY PRECAUTIONS.**

- Rule 29. *Construction, installation, protection, maintenance of Electric supply lines and apparatus :*
- (1) All electrical supply lines and apparatus shall be of sufficient ratings for power, insulation and estimated fault current and of sufficient mechanical strength, for the duty which they may be required to perform under the environmental conditions of installation, and shall be constructed, installed, protected, worked and maintained in such a manner as to ensure safety of personnel and property.
  - (2) Save as otherwise provided in these Rules, the relevant Code of Practice of the Indian Standards Institution if any, may be followed to carry out the purpose of this Rule and in the event of any inconsistency, the provision of these rules shall prevail.
- Rule 31.** *Cut-out on consumer's premises:*
- (1) The supplier shall provide suitable Cut-out in each conductor of every service line other than an earthed or earth neutral conductor or the earthed external conductor of concentric cable within a consumer's premises, in an accessible position. Such Cut-out shall be contained within an adequately enclosed fireproof receptacle.  
Where more than one consumer is supplied through a common service line, each such consumer shall be provided with an independent Cut-out at the point of junction to the common service.
  - (2) Every electric supply line, other than the earthed or earthed neutral conductor of any system, or the earthed external conductor of a concentric cable shall be protected by a suitable Cut-out by its owner.

- Rule 32.** *Identification of earthed and earthed neutral conductors and position of switches and Cut-outs therein:* Where the conductors include an earthed conductor or of a two wire system or an earthed neutral conductor of a multi - wire system or a conductor which is to be connected thereto, the following conditions shall be complied with:
- (1) An indication of a permanent nature shall be provided by the owner of the earthed or earthed neutral conductor or the conductor which is to be connected thereto to enable such conductor to be distinguished from any live conductor. Such indication shall be provided
    - (a) Where the earthed or earthed neutral conductor is the property of the supplier at or near the point of commencement of supply;
    - (b) Where a conductor forming part of a consumer's system is to be connected to the supplier's earthed or earthed neutral conductor at the point where connection is to be made;
    - (c) In all other cases at a point corresponding to the point of commencement of supply or at such other point as may be approved by an Inspector or any officer appointed to assist the Inspector and authorised under sub-rule (2) of Rule 4-A.
  - (2) No Cut-out link or switch other than a linked switch arranged to operate simultaneously on the earthed or earthed neutral conductor and live conductor shall be inserted or remain inserted in any earthed or earthed neutral conductor of a two wire system or in any earthed or earthed neutral conductor of a multi-wire system or in any conductor connected thereto with the following exception:
    - (a) A link for testing purposes: or
    - (b) A switch for use in controlling a generator: or transformer.

(Note :- for the purpose of this Rule the relevant Indian Standard relating to marking and arrangement for switch gear bus-bar main connections and auxiliary writing may be referred to).

**Rule 33. Earthed terminal on consumer's premises :**

- (1) The supplier shall provide and maintain on the consumer's premises for the consumer's use a suitable earthed terminal in an accessible position at or near the point of commencement of supply as defined under Rule 58:

Provided that in the case of medium, high or extra-high voltage installation, the consumer shall, in addition to the afore mentioned earthing arrangement, provide his own earthing system with an independent electrode.

Provided further that the supplier may not provide any earthed terminal in the case of installation already connected to his system on or before the 30th June 1966 if he is satisfied that the consumer's earthing arrangement is sufficient.

- (2) The consumer shall take all reasonable precautions to prevent mechanical damage to the earthed terminal and its lead belonging to the supplier.
- (3) The supplier may recover from the consumer the cost of installation on the basis of schedule of charges notified in advance and where such schedule of charges is not notified, the procedure prescribed in sub-rule(5)of rule 82 will apply.

**Rule 35.** *Danger notices:* The owner of every medium, high and extra high voltage installation shall affix permanently in a conspicuous position a danger notice in Hindi and English and local language of the District with a sign of skull and bones and of a type approved by the Inspector on

- (a) Every motor, generator, transformer and other electrical plant and equipment together with apparatus used for controlling or regulating the same:
- (b) All supports of high and extra-high voltage over- head lines which can be easily climbed upon without the aid of ladder or special appliances:
- (c) Luminous tube sign requiring high voltage supply X-Ray and similar high frequency installations:

Provided that where it is not possible to affix such notices on any generator, motor, transformer or other apparatus, they shall be affixed as near as possible thereto or the word "Danger" and the voltage of the apparatus concerned shall be permanently painted on it:

Provided further that where the generator, motor, transformer or other apparatus is within an enclosure one notice affixed to the said enclosure shall be sufficient for the purpose of this rule.

**Rule -36**      ***Handling of electric supply lines and "apparatus :***

(1) Before any conductor or apparatus is handled adequate precaution shall be taken by earthing or other suitable means or to discharge electrically such conductor or apparatus and any adjacent conductor or apparatus if there is danger there from, and to prevent any conductor or apparatus from being accidentally or inadvertently electrically charged when persons are working thereon.

Every person who is working on an electric supply line or apparatus or both shall be provided with tools and devices such as gloves, rubber shoes, safety belts, ladders, earthing devices, helmets, line testers, hand lines and the alike things for protecting him from mechanical or electrical injury. Such tools and devices shall always be maintained in sound and efficient working conditions:

(2) No person shall work on any live electric supply line or apparatus and no person shall assist such person on such work, unless is authorised in that behalf: and takes the safety measures approved by the Inspector.

(3) Every telecommunication line on supports carry a high or extra high voltage line for the purpose of working thereon be deemed to be a high voltage line.

**Rule 38.**      ***Cables for portable or transportable apparatus:***

(1) Flexible cable shall not be used for portable or transportable motors, generators, transformers, rectifiers, electric drills, electric sprayers, welding sets or any other portable or transportable apparatus unless they are heavily insulated and adequately protected from mechanical injury.



- (2) Where the protection is by means of metallic covering, the covering shall be in metallic connection with the frame of any such apparatus and earth.
- (3) The cables shall be three core type and four core type for portable and transportable apparatus working on single phase and three phase supply respectively and the wire meant to be used for ground connection shall be easily identifiable.

**Rule 41. *Distinction of circuits of different voltages:***

The owner of every generating station, sub-station, junction box or pillar in which there are any circuits or apparatus intended for operation at different voltage or at the same voltage shall ensure by whatever -means of indicating of a permanent nature that respective circuits are readily distinguishable from one another.

Rule 41A. Distinction of the installation having more than one feed by owner of every installation including sub-station, double pole structure, four pole structure or any other structure having more than one - feed, shall ensure by means of indication of a permanent nature that the installation is readily distinguishable from other installations.

Rule 42. *Accident charge:* The owner of all circuits and apparatus shall so arrange them that there shall be no danger of any part thereof becoming accidentally charged to any voltage beyond the limits of voltage for which they are intended.

Where AC. and D.C. circuits are installed on the same support they shall be so arranged and protected that they shall not come into contact with each other when live.

**Rule 43. *Provisions applicable to protective equipment:***

Fire buckets filled with clean dry sand and ready for immediate use for extinguishing fires in addition to fire extinguishers suitable for dealing with electric fires shall be conspicuously marked and kept in all generating stations( enclosed sub-stations and switch station) in convenient situations.

The fire extinguishers shall be tested for satisfactory operation at least once a year and record of such tests shall be maintained.

- (2) First-Aid Boxes or Cup-Boards conspicuously marked and equipped with such contents as the State Government may specify, shall be provided and maintained in every generating station, enclosed sub-station and enclosed switch-station so as to be readily accessible during all working hours. All such boxes and cup-boards shall except in the case of unattended sub-station and switch stations be kept in charge of responsible persons who are trained in first-aid treatment and one ,of such persons shall be available during working hours. .

*Rule 44. Instructions of restoration of persons suffering from electric shocks:*

- (1) Instructions (in English Hindi and the local language of the District and where Hindi is the local language in English. and Hindi) for the restoration of the persons suffering from electric shocks shall be affixed by the owner in a conspicuous place in every generating station, enclosed sub station, enclosed switch station, and in every factory as defined in clause(m) of section 2 of the factories Act-1948(LXIII of 1948) in which electricity used and in such other premises where electricity is used as the Inspector( or any officer appointed to assist the Inspector) may by notice in writing served on the owner, direct.
- (2) Copies of the instructions shall be supplied on demand by an officer or officers appointed by Central or State Government in this behalf at a price to be fixed by the Central or State Government. .
- (3) The owner of every generating Station, enclosed station, enclosed switch station and every factory or other premises to which this rule apply shall ensure that all authorised persons employed by him or acquainted with and are competent to apply the instructions referred to in sub-rule (1).
- (4) In every manned high voltage or extra-high voltage generation station or sub-station an artificial respirator shall be provided and kept in good working condition.

**Rule 44 A.** Intimation of accident' If any accident, occurs in connection with the generation, transmission? supply or use of energy in or in connection With, any part of the electric supply lines or other works of any person and the accident results in or is likely to have resulted in loss of human or animal life or in any injury to a human being or an animal, such person or any authorised persons of the State Electricity Board/supplier', not below the rank of Junior Engineer or equivalent shall send to the Inspector a telegraphic report within 24 hours of the knowledge of occurrence of the fatal accident and written report in the from set out in Annexure-XIII within 48 hours of the knowledge of occurrence of fatal and all other accidents. Where practicable a telephonic message should, also be given to the Inspector immediately the accident comes to the knowledge of the authorised officer of the State Electricity Board! Supplier or other person concerned.

Annexure - XIII

Form Of Reporting Electrical Accidents  
(See Rule 44-A)

1. Date and time of accident
2. Place of accident  
(village / town / Tehsil / Thana / District and State)
3. System and voltage of supply,  
consumer's installations / service lines / other installations)
4. Designation of the officer in charge of the supplier in whose jurisdiction the accident occurred.
5. Name of owner/user of energy in whose premises the accident occurred.
6. Details of victim (s)

(a) Human :

S. No.	Name	Fathers Name	Sex of Victim
1	2	3	4

Full Postal Address	Approximate age	Fatal / non-fatal
5	6	7

**(b) Animal :**

S. No.	Description of Animal (s)	Number (s)
1	2	3

Name(s) of owner (s)	Address (es) of owner (s)	Fatal / non-fatal
4	5	6

7. In case the victim (s) is / are employee (s) of Supplier :
- Designation of such person(s)
  - Brief description of the job undertaken, if any.
  - Whether such person / persons was / were allowed to work on the job.
8. In case the victim (s) is / are employee (s) of a licensed contractor:
- Did the victim (s) possess any electric workmen's permit (s) supervisor's certification of competency issued under rule 45 ?  
If yes, give number and date of issue and the name of issuing authority.
  - Name and designation of the person who assigned the duties of the victim (s).
9. In case of accident in the supplier's system, was the permit to work (PT\V) taken ?

- 10 (a) Describe fully the nature and extent of injuries, e.g. fatal/disablement (permanent or temporary) of any portion of the body or limbs or other injuries.
- (b) In case of fatal accident, was the post mortem performed ?
11. Detailed causes leading to the accident. (to be given in a separate sheet annexed to this form).
12. Action taken regarding first aid, medical attendance etc., immediately after the occurrence of the accident (give details).
13. Whether the District Magistrate and Police Station concerned have been notified of the accident (if so details).
14. Steps taken to preserve the evidence in connection with the accident to extent possible.
15. Name and Designation (s) of the person (8) assisting, supervising the person (s) killed or injured.
16. What safety equipments were given to and used by the person (8) who met with this accident e.g. rubber gloves, rubber mats, safety belts and ladders etc.) ?
17. Whether isolating switches and other sectionalising devices were employed to de-energise the sections for working on the same? Whether working section was certified at the site of work.
18. Whether the work on the live lines was undertaken by authorised person (s) ? If so, the name and the designation of such person (s) may be given.
19. Whether artificial resuscitation treatment was given to, the person (s) who met with electric accident? If yes, how long was it continued before its abandonment?
- ...
20. Names and designations of person(s) present at and witnessed the accident.
21. Any other information / remarks.

Place:  
Time:  
Date:

Signature  
Name  
Designation  
Address of person  
reporting.

Rule 45. Precautions to be adopted by consumers, owners, occupiers, suppliers, electrical contractors, electrical workmen and suppliers:

- (1) No electrical installation work including addition, alternation, repairs and adjustments to existing installation, except such replacement of lamps, fans, fuses, switches, low voltage domestic appliances and fittings as in no way alters its capacity or character shall be carried out upon the premises of or on behalf of any consumer owner or occupier by and electrical control licensed in this behalf by the State Government and Welder the direct supervision of a person. holding a certification of competency and by person holding a permit issued or recognized by the State Government.

Provided that in case of work executed for or on behalf of Central Government and in the case of installations in mines, oilfields and Railways the Central Government and in other cases State Government may by formation in the official Gazette exempt on such conditions as it may impose any such work described therein either generally or in the case of any specified class of consumers or owners from so much of this sub-rule as requires such works to be carried out by an electrical contractor licensed by the State Government in this behalf

- (2) No electrical installation work which has been carried out in contravention of sub-rule (1) shall either be energized or connected to the works of any suppliers.

#### CHAPTER V - GENERAL CONDITIONS RELATING TO SUPPLY AND USE OF ENERGY

Rule 50. Supply and use of energy: (I) The energy shall not be supplied,

transformed, converted or used or continued to be supplied, transformed converted or used unless provisions as set out below are observed :

- (a) The following controls of requisite capacity to carry and break the current are placed as near as possible to, but after the point of commencement of supply as defined in rule 58, so as to be readily accessible and capable of being easily operated to completely isolate the supply to the installation, such equipment being in addition to any equipment installed for controlling individual circuits or apparatus :
  - i) A linked switch with fuse( s) or a circuit breaker by low and medium. voltage consumers

- ii) A linked switch with fuse( s) or a circuit breaker by HV consumers having aggregate installed transformer/ apparatus capacity upto 1000 KVA to be supplied at voltage upto 11 KV and 2500 KV A at higher voltages ( above 11KV and not exceeding 33 KV).
- iii) A circuit breaker by HV consumers having an aggregate installed transformer/ apparatus capacity above 1000 KVA and supplied at 11 KV and 2500 KV A Supplied at higher voltages( above 11kv and not exceeding 33 KV).
- iv) A circuit breaker by EHV consumer;

Provided that where the point of commencement of supply and the consumer apparatus are near each other, one linked switch with fuse(s) or circuit breaker near the point of commencement of supply as required by this clause shall be considered sufficient for the purpose of this Rule.

- (b) In case of every transformer the following shall be provided:
  - (i) On primary side for transformers a linked switch with fuse(s) or circuit breaker of adequate capacity:

Provided that the linked switch on the primary side of the transformer may be of such capacity as to carry the full load current and to break only the magnetizing current of the transformer:

Provided further that for transformers of capacity 5000 KVA and above, a circuit breaker shall be provided;

Provided further that the provision of linked switch on the primary side of the transformer shall not apply to the unit auxiliary transformer of the generator.

- (ii) On the secondary side of transformers of the capacity 100 KV A and above transforming HV to MV or LV a linked switch with fuse( s) or circuit breaker of adequate capacity capable of carrying and breaking full load current and for transformers transforming HV to EHV as the case may be, a circuit breaker.

Provided that where the transformer capacity exceeds 630 KV A a circuit breaker of adequate capacity shall be installed on the secondary side.



- (c) Except in the case of composite control gear designed as a unit distinct circuit is protected against excess energy by means of suitable cut out or a circuit breaker of adequate breaking capacity suitably located and so constructed as to prevent danger from overheating, arcing or scattering of hot metal when it comes into operation and to permit for ready renewal of the fusible metal of the cut-out without danger;
  - (d) The supply of energy to each motor or group of motors or other apparatus meant for operating one particular machine is controlled by a suitable linked switch or a circuit breaker or an emergency tripping device with manual reset of requisite capacity placed in such a position as to be adjacent to the motor or a group of motors or other apparatus readily accessible to and easily operated by the person in charge and so connected in the circuit that by its means all supply of energy can be cut off from the motor or group of motors of apparatus from any regulating switch, resistance of other device associated therewith;
  - (e) All insulating materials are chosen with special regard to the circumstances of its proposed use and their mechanical strength is sufficient for its purpose and so far as is practicable of such a character or so protected as to maintain adequately its insulating property under all working conditions in respect of temperature and moisture; and
  - (f) Adequate precautions shall be taken to ensure that no live parts are so exposed as to cause danger.
- (2) Where energy is being supplied, transformed, converted or used, the consumer or the owner of the concerned installation shall be responsible for the continuous observance of the provisions of sub- rule (1) in respect of his installations.
- (3) Every consumer shall use all reasonable means to ensure that where energy is supplied by a supplier no person other than the -, supplier shall interfere with the service lines and apparatus placed by the supplier on the premises of the consumer.

**Note :-** The principal rules were published in the Gazette of India vide Government notification, Ministry of Irrigation and Power No. SRO 1455 Dated 26th June, 1956.

**50A.** Additional provisions for supply and use of energy in multistoried buildings (more than 15 meters in height) :

- (1) Before making an application for commencement of supply or recommencement of supply after an installation has been disconnected for a period of 6 months or more the owner / occupier of a multistoried building shall give not less than 30 days notice in writing to the Inspector together with particulars. The supply of energy shall not be commenced or recommended within this period, without the approval or to otherwise in writing of the Inspector;
- (2) The supplier / owner of the installation shall provide, at the point of commencement of supply a suitable isolating device with cutout or breaker to operate on all phases except neutral in the 3 phase 4 wire circuit and fixed in a conspicuous position at not more than 2.75 metres above the ground so as to completely isolate the supply to the building in case of emergency;
- (3) The owner / occupier of a multistoried building shall ensure that electrical installations / works inside the building carried out and maintained in such a manner as to prevent danger due to shock and fire hazards, and the installation is carried out in accordance with the relevant codes of practices.
- (4) No other service pipes shall be taken along with the ducts provided for laying power cables. All ducts provided for power cables and other services shall be provided with barrier at each floor crossing.

**Rule 51.** Provisions applicable to medium high or extra-high voltage installation:- The following provisions shall be observed where energy at medium high or extra-high voltage is supplied, converted, transformed or used:

- (1) (a) All conductors (other than those of over head lines) shall be completely enclosed in mechanically strong metal casing or metallic covering which is electrically and mechanically continuous and adequately protected against mechanical damage unless the said conductors are accessible only to an authorised person or are installed and protected to the satisfaction of the Inspector so as to prevent danger:

Provided that rigid non-metallic conduits conforming to Indian Standards Specification No.IS 2609-1963. Rigid non-metallic conduits for electrical installation may be used for medium voltage installation subject to conditions as the Inspector or such officer appointed to assist an Inspector may think fit to impose.

- (b) All metal works, enclosing, supporting or associated with the installation other than that designed to serve as a conductor shall be connected with an earthing system as per standards laid down in the Indian Standards in this regard and in also accordance to with Rule 61(4)."
- (c) Every switchboard shall comply with following provisions, namely:
  - (i) A clear space of not less than 1 metre (3 feet) in width shall be provided in front of the switchboard:
  - (ii) If there are any attachments or bare connections at the back on the switchboard the space (if any) behind the switch board shall be either less than 200 mm or more than 750 mm in width measured from the farthest outstanding part of any attachment or conductor;
  - (iii) If the space behind the switchboard exceeds 750 mm.(30 inches) in width there shall be a passage way from either end of the switchboard clear to a height of 1.8 metre( 6 feet).
- (d) In case of installations provided in premises where inflammable materials including gases and or chemicals are produced, handled or stored, the electrical installations, equipment and apparatus shall comply with the requirements of flame proof: dust tight, totally enclosed or any other suitable type of electrical fittings depending upon the hazardous zones as per the relevant Indian Standards Specifications."

**Rule 56. Sealing of meter and cut-outs:**

- (1) A supplier may affix one or more seals to any cut-out and any meter maximum demand indicator, or other apparatus placed upon consumer's premises in accordance with section 26, and no person other than the supplier shall break any such seal.
- (2) The consumer shall use all reasonable means in his power to ensure that no such seal is broken otherwise than by the supplier.

**Rule 58.** Point of commencement of supply:- The point of commencement of supply of energy to consumer shall be deemed to be the point at the out-going terminals of the cut-outs inserted by the supplier in each conductor of every service line other than an earthed or earthed neutral conductor or earthed external conductor of a concentric cable at the consumers premises.

**CHAPTER-VI- ELECTRIC SUPPLY LINE SYSTEMS AND APPARATUS FOR  
LOW AND MEDIUM VOLTAGES.**

**Rule 61. Connection with earth :**

- (1) The following provisions shall apply to the connection with earth of systems at low voltage in cases where the Voltage (Between phase or outers) normally exceeds 125 Volts and of system at .medium voltage:
  - "(a) Neutral conductor of a 3-phase, 4 wire system and the middle conductor of a 2-phase, 3-wire systems shall be earthed by not less than two separate and distinct connections with a minimum of two different earth electrodes or such large number as may be necessary to bring the earth resistance to a satisfactory value both at the generating station and at the sub-station. The earth electrodes so provided, may be inter-connected to reduce earth resistance. It may also be earthed at one or more points along the distortion system or service line in addition to any connection with earth which may be at the consumers premises.
  - (b) In the case of a system comprising electric supply line having concentric cables, the external conductor of such cables shall be earthed by two separate and distinct connection with earth;
  - (c) The connection with earth may include a link by means of which the connection may be temporarily interrupted for the purpose of testing or for locating a fault;
  - (e) In the case of an alternating current system, there shall not be inserted in the connection with earth any impedance (other than that required solely for the operation of switchgear or instrument), cut-out or circuit breaker and the result of any test made to ascertain whether the current (if any) passing through the connection with the earth is normal, shall be duly recorded by the supplier;

## 26-197

- (f) No person shall make the connection with earth by the side to: nor shall keep it in contact with water main not belonging to him except with the consent of the owner thereof and of the Inspector;
- (g) Alternating current system which are connected with earth as aforesaid may be electrically inter-connected.

Provided that each connection with earth is bounded to the metal sheathing and metallic armouring (if any) of the electric supply lines concerned.

- (2) The frame of every generator, stationary motor, portable motor and the metallic parts (not intended as conductors) of all transformers and any other apparatus used for regulating or controlling energy and all medium voltage energy consuming apparatus shall be earthed by the owner by two separate and distinct connections with earth.
- (3) All metal castings or metallic coverings containing or protecting any electric supply line or apparatus shall be connected with earth and shall be so joined and connected across all junction boxes and other opening as to make good mechanical and electrical connection through out their whole length:

Provided that where the supply is at low voltage this sub-rule shall not apply to isolated wall tubes or to brackets, electro tires, switches ceiling fans or other fittings (other than portable hand-lamp and portable and transportable apparatus) unless provided with earth terminal:

Provided further that where the supply is at low voltage and where the installation are either new or renovated all plug sockets shall be of three pin type, and the third pin shall be permanently and efficiently earthed.

The sub-rule shall come into force immediately in the case of new installations and in the case of existing installations the provisions of this sub-rule shall be complied with before the expiry of a period of two years from the commencement of this rule.

- (4) All earthing system shall ;
- (a) Consist of equipotential bonding conductors capable of carrying the perspective earth fault current and a group of pipe / rod / plate electrodes for dissipating the current to the general mass of earth without exceeding the allowable temperature limits as per relevant Indian Standards in order to maintain non-current carrying metal works reasonably of earth potential and to avoid dangerous contact potential being developed on such metal works.
  - (b) Limit earth resistance sufficiently low to permit adequate fault current for the operation of protective devices in time and to reduce neutral shifting;
  - (c) Be mechanically strong, withstand corrosion and retain electrical continuity during the life of the installation. All earthing systems shall be tested to ensure efficient earthing, before the electric supply lines or apparatus are energized. "
- (5) All earthing system belonging to the supplier shall in addition be tested for resistance on dry day during dry season not less than once in every two years.

**" 61-A.** The supply of energy to every electrical installation other than low / voltage installation below 5 KW and those low voltage installations which do not attract provisions of section 30 of the Indian Electricity Act, 1910 shall be controlled by an earth leakage protective device so as to disconnect the supply instantly on the occurrence of earth fault or leakage of current.

Provided that the above shall not apply, to over head supply line having protective devices which are effectively bonded to the neutral of supply transformers and confirming to rule-91 of I.E. Rules, 1956. "

**Rule 62-** *System at a medium voltage:-* Where a medium voltage supply system is employed, the voltage between earth and any conductor forming part of the same system shall not, under normal conditions, exceed low voltage.

**CHAPTER - VII - ELECTRIC SUPPLY LINE, SYSTEMS AND APPARATUS  
FOR HIGH AND EXTRA HIGH VOLTAGES.**

**" 64** Use of energy at high and extra high voltage.

- (1) The Inspector shall not authorise the supplier to commence supply or where the supply has been discontinued for a period of one year and above, to recommence the supply at high or extra high voltage to any consumer 'unless;
  - (a) All conductors and apparatus situated on the premises of the consumer are so placed as to be in accessible except to an authorised person and all operations in connection with the said conductors and apparatus are carried out by an authorised person;
  - (b) The consumer has provided and agrees to maintain separate building or a locked weather-proof and fire-proof enclosure of agreed design and location, to which the supplier at all times have access for the purpose of housing his apparatus and metering equipment, or where the provision for a separate building or enclosure is impracticable, the consumer has segregated the aforesaid apparatus of the supplier from any other part of his own apparatus;

Provided that such segregation shall be by the provision of fire proof walls, if the Inspector considers it to be necessary:

Provided further that in the case of an out-door installation consumer shall suitably segregate the aforesaid apparatus belonging to the supplier from his own to the satisfaction of the Inspector;

- (c) All pole type sub-stations are constructed and maintained in accordance with rule 69.
- (2) The following provision shall be observed where energy at high or extra high voltage is supplied, converted, transformed or used:
  - (a) Clearances as per Indian Standards Code shall be provided for electrical apparatus so that sufficient space is available for easy operation and maintenance without any hazard to the operating and maintenance personnel working near the equipment and for ensuring adequate ventilation.

## 26-200

- (ii) The following minimum clearances shall be maintained for bare conductor or live parts of any apparatus out-door sub-stations,

excluding over head lines, of HV and EHV installations :

Voltage Class	Ground clearance (metres)	Sectional Clearance (Metres)
Not exceeding 11KV	2.75	2.6
-D0- 33 KV	3.7	2.8
-D0- 66 KV	4.0	3.0
-D0- 132 KV	4.6	3.5
-D0- 220 KV	5.5	4.3
-D0- 400 KV	8.0	6.5

- (b) The winding of motors or other apparatus within reach from any position in which a person may require to be, shall be suitably protected so as to prevent danger.
- (c) Where transformer or transformers are used, suitable provision shall be made, either by connecting with earth a point of the circuit at the lower voltage or otherwise to guard against danger by reason of the said circuit becoming accidentally charged above its normal voltage by leakage from or contact with the circuit at the higher voltage;
- (d) A sub-station or switch station with apparatus having more than 2000 litres of oil shall not be located in the basement where proper oil draining arrangement cannot be provided;
- (e) Where a sub-station or a switch station with apparatus having more than 2000 litres of oil is installed, whether indoors or outdoors, the following measures shall be taken namely:
- (i) The baffle walls of 4 hour fire rating shall be provided between the apparatus in the following cases :
- (A) Single phase banks in the switch yards of generating stations and sub-stations;
- (B) On the consumer premises;
- (C) Where adequate clearance between the units is not available.



## 26-201

- (ii) Provisions shall be made for suitable oil soak pit and where use of more than 9000 litres of oil in anyone oil tank, receptacle or chamber is involved, provision shall be made for draining away or removal of any oil which may leak or escape from the tanks receptacles or chambers containing the same, special precautions shall be taken to prevent the spread of any fire resulting from the ignition of the oil from any cause and adequate provision shall be made for extinguishing any fire which may occur. Spare oil shall not be stored in any sub-station or switch station.
- "(f) (i) Without prejudice to the above measures, adequate fire protection arrangement shall be provided for quenching the fire in the apparatus;
- (ii) Where it is necessary to locate the sub-station / switch-station in the basement following measures shall be taken:
  - (a) The room shall necessarily be in the first basement at the periphery of the basement;
  - (b) The entrances to the room shall be provided with fire resisting doors oi2 hour fire rating. A curb (sill) of a suitable height shall be provided at the entrance in order to prevent the flow of oil from the matured transformer in to other parts of the basement. Direct access to the transformer room shall be provided from out-side;
  - (c) The transformer shall be protected by a automatic high velocity water spray system or by carbon dioxide or BCF (Bromocloro difluoromethane) or BTM (Bromo trifluoromethane) fixed installation system; and
  - (iii) Oil filled transformers installed indoors shall not be on any floor above the ground or below the first basement,
  - (g) Cable trenches inside the sub-stations and switch-Stations containing cables shall be filled with sand, pebbles or similar inflammable materials or completely covered with noninflammable slabs;
  - (h) Unless the conditions are such that all the conductors and apparatus may be made dead at the same time for the purpose of cleaning or for other work, the said conductors and apparatus

shall be so arranged that these may be made dead in sections, and that work on any such section may be carried on by an authorised person without danger.

- (i) Only persons authorised under sub-Rule(1) of Rule 3, shall carry out the work on live lines and apparatus.

" **64-A-** The following additional provision shall be observed where energy at high or extra high voltage is supplied, converted, transferred or used, namely:

- (1) **Inter-locks :** .Suitable inter-locks shall be provided in the following cases :-
  - (a) Isolators and the controlling circuit breakers shall be inter-locked so that the isolators can not be operated unless the corresponding breaker is in open position;
  - (b) Isolators and the corresponding earthing switches shall be interlocked so that no earthing switch can be closed unless and until the corresponding isolator is in open position;
  - (c) Where two or more supplies are not intended to be operated in parallel, the respective circuit breakers or linked switches controlling the supplies shall be inter-locked to prevent possibility of any inadvertent paralleling of feed back.
  - (d) When two or more transformers are operated in parallel, the system shall be so arranged as to trip the secondary breaker of a transformer in case the primary breaker of that transformer trips;
  - (e) All gates or all doors which give access to live parts of an installation shall be inter-locked in such a way that these can not be opened unless the live parts are made dead. Proper discharging and earthing of these parts should be ensured before any person comes in close proximity of such parts;
  - (f) Where two or more generators operate in parallel and neutral switching is adopted, inter-lock shall be provided to ensure that generator breaker can not be closed unless one of the neutrals is connected to the earthing system

(2) **Protection:-** All systems and circuits shall be so protected as to automatically disconnect the supply under abnormal condition. The following protection shall be provided, namely:

- (a) Over current protection to disconnect the supply automatically if the rated current of the equipment, cable or supply line is exceeded for a time which the equipment, cable or supply line is not designed to withstand;
- (b) Earth fault / earth leakage protection to disconnect supply automatically if the earth fault current exceeds the limit of current for keeping the contact potential within reasonable values;
- (c) Gas pressure type protection to give alarm and tripping shall be provided on all transformers of ratings 1000 KV A and above;
- (d) Transformers of capacity 10 MY A and above shall be protected against incipient faults by differential protection; and
- (e) All generators with rating 100 KV A and above shall be protected against earth fault / leakage. All generators of rating 1000 KV A and above shall be protected against faults within the generator winding using restricted earth fault protection or differential protection or both. "

**"65. Testing, Operation and Maintenance:**

- (1) - Before approval is accorded by the Inspector under rule-63 the manufacturer's test certificate shall, if required, be produced for all the routine tests as required under the relevant Indian Standards.
- (2) No new HV or EHV apparatus, cable or supply line shall be commissioned unless such apparatus, cable or supply line are subjected to site tests as per relevant code of practice of the Indian Standards Institution.
- (3) No HV or EHV apparatus, cable or supply line which has been kept disconnected, for a period of 6 months or more, from the system for alternations or repair shall be connected to the system until such apparatus cable or supply line subjected to the relevant tests as per code of practice of Indian Standards Institution.

- (4) Notwithstanding the provisions of sub-rule (1) to (3) (both inclusive) the Inspector may require certain additional tests to be carried Out before charging the installation or subsequently.
- (5) All apparatus, cable and supply lines shall be maintained in healthy conditions and tests shall be carried out periodically as per the relevant codes of practice to the Indian Standards Institutions.
- (6) Records of all tests, trappings, maintenance works and repairs of all equipment, cables and supply lines shall be duly kept in such a way that these records can be compared with earlier once; and
- (7) It shall be the responsibility of the owner of all HV and EHV installation to maintain and operate the .installations in a condition free from danger and as recommended by the manufacturer and / or by the relevant codes of practice of the Indian Standards Institution and / or by the Inspector."

**Rule. 66- Metal sheathed electric supply lines** - Precautions against excess leakage: The following provisions shall apply to electric supply lines (other than over head lines) of a supplier for use at high or extra high voltage:

- (a) The conductors shall be enclosed in a metal sheathing which shall be electrically continuous and connected with earth, and the conductivity of the metal sheathing shall be maintained and reasonable precaution taken where necessary to avoid corrosion of the sheathing:

Provided that in the case of thermo-plastic insulated and sheathed cables with metallic armour, the metallic wire or tape armour shall be considered as metal sheathing for the purpose of this rule,

Provided further that this rule shall not apply to cables with thermo-plastic insulation without any metallic screen or armour.

- " (b) The resistance of the earth connection with metallic sheath shall be kept tow enough to permit the controlling circuit breaker or cut-out to operate in the event of any failure of insulation between the metallic sheath and the conductor."

- (c) Where an electric supply line as aforesaid has concentric cables and the external conductor is insulated from an outer metal sheathing and connected with earth, the external conductor may be regarded as the metal sheathing for the purposes of the rule provided that the foregoing provisions as to conductivity are complied with :
- (d) Nothing in the provision of sub-rule ( 13) shall preclude the employment in generating stations, sub-stations and switch stations (including out-door sub-station, and out-door switch stations) of conductors for use at high or extra high voltage which are not enclosed in metal sheathing or preclude the use of electric supply line laid before the prescribed date to which the provisions of these rules apply.

**Rule 61**      ***Connection with earth:***

- (1) All non-current carrying metal parts associated with HV / EHV installations shall be effectively earthed to a grounding system or mat which will :
  - (a) Limit the touch and step potential to tolerable values;
  - (b) Limit the ground potential rise to tolerable values so as to prevent danger due to transfer of potential through ground, earth wires, cable sheath fences, pipe lines, etc.
  - (c) Maintain the resistance of earth connection to such a value as to make operation of the protective device effective.
- (IA) In the case of star - connected system with earthed neutrals or delta connected system with earthed artificial neutral point:
  - (a) The neutral point of every generator and transformer shall be earthed by connecting it to the earthing system as defined in rule 61 (4) and herein above by not less than two separate and distinct connections:

Provided that the neutral point of a generator may be connected to the earthing system through an impedance to limit the fault current to the earth :

Provided further that in case of multi-machine system neutral switching may be resorted to, for limiting the injurious effect of harmonic - current circulation in the system:

## 26-206

- (b) In the event of an appreciable harmonic current flowing in the neutral connection so as to cause interference with communication circuits, the generator or transformer neutral shall be earthed through a suitable impedance.
  - (c) In case of the delta connected system the neutral point shall be obtained by insertion of a grounding transformer and current limiting resistance or impedance wherever necessary at the commencement of such a system."
  - (d) Single - phase high or extra-high voltage systems shall be earthed in a manner approved by the Inspector.
  - (e) Where the earthing load and earth connections are used only in connection with earthing guards erected under high or extra-high voltage overhead lines where they cross a tele-communication line or a Railway line, and where such lines are equipped with earth leakage relays of a type and setting approved by the Inspector the resistance shall not exceed 25 ohms.
- (5) (b) Every earthing system belonging to either the supplier or the consumer shall be tested for its resistances to earth on a dry day season not less than once a year. Records of such tests shall be maintained and shall be produced, if required, before the Inspector or any officer appointed to assist him
- (6) In so far as the provisions of rule 61 or consistent with provisions of this rule, all connections with earth shall also comply with the provisions of that rule.

### **Rule 68 - General conditions as to transformation and control of energy :**

- (1) Where energy at high or extra-high voltage is transformed, converted, regulated or otherwise controlled in sub-stations or switches-stations (including out-door sub-stations and switch stations) or in street boxes contracted underground, the following provisions shall have effect

- "(a) Sub-stations and switch-stations shall preferably be erected above ground, but where necessarily constructed under ground, due provisions for ventilation and drainage shall be made and any space housing switch gear shall not be used for any materials especially inflammable and combustible materials or refuse."
- (b) Out-door sub-stations except pole type sub-stations and out-door switch-stations shall (unless the apparatus is completely enclosed in a metal covering connected with earth, the said apparatus also being connected with the system by armored cables) be efficiently protected by fencing not less than 1.8 metres in height or other means so as to prevent access to the electric supply lines and apparatus therein by an unauthorized person;
- (c) Underground street boxes (other than sub-stations) which contain transformers shall not contain switches or other apparatus and switches cut-outs or other apparatus required for controlling or other purposes shall be fixed in separate receptacles above ground wherever practicable.
- (2) Where energy is transformed, suitable provisions shall be made either by connecting with earth a point of the system at the lower voltage or otherwise to guard against danger by reason of the said system becoming accidentally charged above its normal voltage by leakage :Item a contact with the system at the high voltage.

**Rule 69 - Pole type sub-stations :-** Where platform type construction is used for a pole type sub-station and sufficient space for a person to stand on the platform is provided, substantial hand rail shall be built around the said platform and if hand rail is of metal, it shall be connected with earth:

Provided that in case of pole type sub-station on wooden support and wooden platform the metal hand rail shall not be connected with earth.

**Rule 71 sign installation:**

- (1) Additional provision for supply to high voltage luminous tube Any person who proposes to use or who is using energy for the purpose of operating a luminous tube-sign installation, or who proposes to transform or who is transforming energy, to a high voltage and such purpose shall comply with the following condition:

## 26-208

- (a) All live parts of the installation including all apparatus and live conductors in the secondary circuit; but excluding the tubes (except in the neighborhood of their terminals) shall be inaccessible to unauthorized persons and such part shall be effectively screened;
- (b) Irrespective of the method of obtaining the voltage of the circuit which feeds the luminous discharge-tube sign, no part of any conductor of such circuit shall be in metallic connection (except in respect of its connections with earth) with any conductor of the supply system or with the primary winding of the transformer
- (c) All live parts of an exterior installation shall be so disposed as to protect them against the effect of the weather, and such installation shall be so arranged and separated from its surroundings as to limit, as far as possible, the spreading of fire;
- (d) The secondary circuit shall be permanently earthed at the transformer and the core of every transformer shall be earthed;
- (e) Where the conductors of the primary circuits are not in metallic connection with the supply conductors( e.g., where a meter generator or a double wound convector is used), one phase of such primary circuit shall be permanently earthed at the motor generator or converter or at the transformer;
- (e) - An earth leakage circuit breaker of sufficient rating shall be provided on the low voltage side to detect the leakage in such luminous tube sign installations.
- (f) A final sub-circuit which forms the primary circuit of a fixed luminous discharge-tube sign installation shall be reserved solely for such purpose;
- (g) A separate primary final sub-circuit shall be provided for each transformer or each group of transformers having an aggregate input not exceeding 1000 Volt amperes of a fixed luminous discharge-tube sign installations :
- (h) An interior installation shall be provided with suitable adjacent means for disconnecting all phases of the supply except the "neutral" in a three-phase four-wire circuit;



- (i) For installation on the exterior of a building a suitable emergency fire proof linked switch to operate on all phases except the neutral in three-phase four-wire circuit shall be provided and fixed in a conspicuous position at not more than 2.743 metres (9 feet) above the ground;
- (k) A special "caution" notice shall be affixed in a conspicuous place on the door of every high voltage enclosure to the effect that the low voltage supply must be cut off before the enclosure is opened;
- (l) Where the static condensers are used, they shall be installed on the load side of the fuses and the primary (low voltage) side of the transformer;
- (m) Where static condensers are used on primary side, means shall be provided for automatically discharging the condensers when the supply is cut off:

Provided that static condensers or any circuit interrupting devices on the high or extra-high voltage side shall not be used, without the approval in writing of the Inspector.

The owner or user of any luminous discharge-tube sign or similar high voltage installment shall not bring the same into use without giving to the Inspector not less than 8 days notice in writing of his intention so to do.

## **CHAPTER VIII - OVERHEAD LINES.**

### **Rule 74 - Material and strength:**

(1) All conductors of overhead lines other than those specified in sub-rule (1) of rule 86 shall have a breaking strength of not less than 350 kg. (700 lb.)

(2) Where the voltage is low and the span is less than 15.24 meter (50 feet) and is in the owner or Consumer's premises, Conductor having an actual breaking strength of not less than 150 kg. (300 lb.) may be used.

**Rule 75. Joints:-** Joints between conductors of overhead lines shall be mechanically and electrically secured under the conditions of operations. The ultimate strength of the joint shall not be less than 95 percent of that of the conductor, and the electrical conductivity not less than that of the conductor.

**Rule 76 Maximum stresses factors of safety:**

- (1) (a) The owner of every overhead line shall ensure that it has the following minimum factors of safety.
- |       |   |     |
|-------|---|-----|
| (i)   | For metal supports                          | 1.5 |
| (ii)  | For mechanically processed concrete support | 2.0 |
| (iii) | For hand moulded concrete supports          | 2.5 |
| (iv)  | For wood supports                           | 3.0 |

The minimum factors of safety shall be based on such load as would cause failure of the supports to perform its functions assuming that the foundation and other components of the structure are intact.

The aforesaid load shall be

- (i) Equivalent to the yield point stress or the modulus of rupture, as the case may be, for supports subject to bending and vertical loads;
- (ii) The crippling load for supports used at struts. The said owner shall also ensure that the strength of the supports in the direction of the wire is not less than one-fourth of the strength required in the direction transverse to the line :

Provided that in the case of latticed steel or other compound structures factors of safety shall not be less than 1.5 under such broken wire conditions as may be specified by the State Government in this behalf.

- (b) The minimum factor of safety for stay wires, guard wires or bearer wires shall be 2.5 based on the ultimate strength of the wire.
- (c) The minimum factor of safety for conductors shall be 2, based on their ultimate tensile strength. In addition, the conductor's tension at (32°C) without external load, shall not, exceed the following percentages of the ultimate tensile strength of the conductor:

## 26-211

Initial unloaded tension	35 percent.
Final unloaded tension	25 percent.

Provided that in the case of conductor having the cross-section of a generally triangular shape such as conductors composed of 3 wires, the final unloaded tension at (32°C) shall not exceed 30 percent of the ultimate tensile strength of such conductors.

- (2) For the purpose of calculating the factors of safety described in sub - rule (1),
  - (a) The maximum wind pressure shall be such as the State Government may specify in each case;
  - (b) For cylindrical bodies the effective area shall be taken as two third of the projected area exposed to wind pressure;
  - (c) For latticed steel or other compound structure the wind pressure on the leeward side members shall be taken as one half of the wind pressure on the windward side members and the factors of safety shall be calculated on the crippling load of struts and upon the elastic limit of tension members.
  - (d) The maximum and minimum temperatures shall be such as the State Government may specify in each case.
- (3) Notwithstanding anything contained in sub-rules (1) and (2), in localities where overhead lines are liable to, accumulation of ice or snow, the State Government may, by order in writing specify the loading conditions for the purpose of calculating the factor of safety.

### **Rule 77 Clearance above ground of the lowest conductor:**

- (1) No conductor or an overhead line, including service line, erected across street shall at any part thereof be at a height less than
  - (a) For low and medium voltage line- 5.8 metres (19 feet).
  - (b) For high voltage lines- 6.1 metres (20 feet)
- (2) No conductor of an overhead line, including service line, erected along any street shall at any part thereof be at height less than

## 26-212

- (a) For low and medium voltage lines- 5.5 metres (18 feet).
- (b) For high voltage lines- 5.8 metres (19 feet).
- (3) No conductor of an overhead line including, service lines, erected elsewhere than along or across any street shall be at height less than
  - (a) For low, . medium and high voltage lines upto and including 11,000 Volts, if bare - 4.6 metres (15 feet).
  - (b) For low, medium and high voltage lines up to and including 11,000 Volts, if insulated.,4 metres (13 feet).
  - (c) For high voltage lines above 11,000 Volts, 5.2 metres (17 feet).

For extra-high voltage lines the clearance above ground shall not be less than 5.2 metres (17 feet) plus 0.3 metres (1 foot) for every 33,000 Volts or part thereof by which the voltage of the line exceeds 33,000 Volts:

Provided that the minimum clearance along or across any street shall not be less than 6.1 metres (20 feet).

### **Rule 78 - Clearance between conductors and trolley wires:**

No conductors of an overhead line crossing a tramway or trolley bus route using trolley wires shall have less than the following clearance, above any trolley wires:

- (a) Low and medium voltage line - 1.2 metres (4 feet).

Provided that where an insulated conductor suspended tom a bearer .Wire crosses over a trolley wire the minimum clearance for such insulated conductor shall be 0.6 metres (2 feet).

- (b) High voltage lines up to and including 11, 000 Volts - 1.8 metres (6 feet).
- (c) High voltage above 11,000 Volt- 2.5 metres(8 feet).
- (d) Extra-high voltage lines- 3 metres( 10 feet).

**Rule 79 Clearance from buildings of low and medium voltage lines:**

(1) Where a low or medium voltage overhead lines passes above or adjacent to or terminate on any building the following minimum clearances nom any accessible point on the basis of maximum sag, shall be observed.

- (a) For any flat roof: open balcony verandah roof and lean to roof
  - (i) When the line passes above the building a vertical clearance of 2.5 metres (8 feet) nom the highest point; and
  - (ii) When the line passes adjacent to the building a horizontal clearance of 1.2 metres (4 feet) nom the nearest point, and
- (b) For pitched roof
  - (i) When the line passes above the building a vertical clearance of 2.5 metres (8 feet) immediately under the lines; and
  - (ii) When the line passes adjacent to the building a horizontal clearance of 1.2 metres (4 feet).
- (2) Any conductor so situated as to have a clearance less than that specified in sub-rule (I) shall be adequately insulated and shall be attached at suitable intervals to a bare earthed bearer wire having a breaking strength of not less than 350 kg. (700 lb.).
- (3) - The horizontal clearance shall be measured when the line is at a maximum deflection nom the vertical due to wind pressure.

**Rule 80 - Clearance from buildings of high and extra-high voltage line:**

- (1) Where a high or extra. high voltage overhead line passes above or adjacent any building or part of a building it shall have on the basis of maximum sag a vertical clearance above the highest part of the building immediately under such line, of not less than
  - (a) For high voltage line up to and including 33,000 Volts - 3.7 metres (12 feet).
  - (b) For extra-high voltage line - 3.7 metres(12 feet) plus 0.3 metre (1 foot) for every additional 33,000 Volts or part thereof

- (2) The horizontal clearance between the nearest conductor and any part of such building shall, on the basis of maximum deflection due to wind pressure, be not less than
- (a) For high voltage lines up to and including 11,000 Volts - 1.2 metre (4' feet).
  - (b) For high voltage line above 11,000 Volts and up to and including 33,000 Volts - 2 metres (6 feet)
  - (c) For extra-high voltage lines 2 metres (6 feet) plus-0.3 metre (1 foot) for every additional 33,000 volts or part thereof.

**Rule 81 Conductors at different voltage on same supports;**

Where the conductors forming part of system at different voltages are erected on the same supports, the owner shall make adequate provision to guard against danger to lineman and others from the lower voltage system being charged above its normal working voltage by leakage from or contact with the higher voltage system, and the methods of constructions and the clearances between the conductors or the two systems shall be subject to the prior approval of the Inspector.

**Rule 82** Erection of or alteration to buildings, structures, flood banks and elevation of roads;

(1) If at any time subsequent to the erection of an overhead line (whether covered with insulating material or bare) any person proposes to erect a new building or structure or flood bank or to raise any road level or to carry out any other type of work whether permanent or temporary or to make in or upon any building or structure or flood bank or road any permanent or temporary addition or alteration, he and the contractor whom he employs to carry out the erection, addition or alteration, shall if such work, building, structure, flood bank, road or additions and alterations thereto would, during or after the construction result in contravention of any of the provision of rules 77,79 or 80, 'give notice in writing of his intention to the supplier and to the Inspector and shall furnish therewith a scale drawing showing the proposed building, structure, flood bank, road, any addition or alteration and scaffolding required during the constructions.

- (2) (a) On receipt of the notice referred to in sub-rule (1) or otherwise, the supplier shall examine whether the line under reference was lawfully laid and whether the person was liable to pay the cost of alteration and if so, send a notice without undue delay, to such

person together with an estimate of the cost of expenditure likely to be incurred to so alter the overhead line and require him to deposit within 30 days of the receipt of the notice with the supplier, the amount of the estimated cost.

- (b) If the person referred to in sub-rule (1) disputes the supplier's estimated cost of alteration of the overhead line or even the responsibility to pay such cost, the dispute may be referred to the Inspector by either of the parties whereupon the same shall be decided by the Inspector.

(3) No work upon such building, structure, flood bank, road and addition or alteration thereto shall be commenced or continued until the Inspector has certified that the provisions of the rules 77, 79, 80 are not likely to be contravened either during or after the aforesaid constructions:

Provided that the Inspector may, if he is satisfied that the overhead line has been so guarded as to secure the protection of persons property from injury, or risk of injury, permit the work to be executed prior to the alteration of the overhead line or, in the case of temporary addition or alteration, without alteration of the overhead line.

(4) On receipt of the deposit the supplier shall alter the overhead line within one month of the date of deposit or within such longer period as the Inspector may allow and ensure that it shall not contravene the provisions of the rule 77, 79 or 80 either during or after such construction.

(5) In the absence of an agreement to the contrary between the parties concerned, the cost of such alteration of the overhead line laid down shall be estimated on the following basis, namely :

- (a) The cost of additional material used on the alteration giving due credit for the depreciated cost of the material which would be available from the existing line;
- (b) The wages of labour employed in effecting the alteration ;
- (c) Supervision charges; to the extent of 15 percent of the wages mentioned in clause (b); and
- (d) Any charges incurred by the supplier in complying with the provisions of section 16 of the Act in respect of such alterations.

- (6) Where the estimated cost of the alteration of the overhead line is not deposited, the supplier shall be considered as an aggrieved party for the purpose of this rule.

**" 82 - A. Transporting and storing of material near overhead lines :**

- (1) No rods, pipes or similar materials shall be taken below or in the vicinity of any bare overhead conductor or lines if they are likely to infringe the provision for clearances under rules 79 and 80, unless such materials are transported under the direct supervision of a competent person authorised in this behalf by the owner of such overhead conductors or lines;
- (2) Under no circumstances rods, pipes or other similar materials shall be brought within the flash over distance of bare live conductors of lines ; and
- (3) No material or earth work or agricultural produce shall be dumped or stored .or trees grown below or fu the vicinity of bare overhead conductors lines so as to reduce the requisite safety clearance specified under rules 79 and 80."

**Rule 83 - Clearance General** - For the purpose of computing the vertical clearance of an overhead line, the maximum sag of any conductor shall be calculated on the basis of maximum sag in still an- and the maximum temperature as specified by the State Government under rule 76 (2) (d). Similarly, for the purpose of computing any horizontal clearance of an overhead line, the maximum deflection of any conductor shall be calculated on the basis of wind pressure specified by the State Government under Rule 75 (2) (a) or may be taken as 35 Degree, which ever is greater.

**Rule 84 - Routes:**" Proximity to aerodromes: Overhead lines shall not be created in the vicinity of aerodrome until the aerodrome authorities have approved in writing the route of the proposed lines.

**Rule 85 - Maximum intervals between supports:** All conductors shall be attached to supports at intervals not exceeding the safe limits based on the ultimate strength of the conductors and the factor of safety prescribed in rule 76:

Provided that in case of overhead lines clarifying low or medium voltage conductors, when erected in over, long or across any street, the interval shall not, without the consent in writing of the Inspector, exceed 67 metres (220 feet):



**Rule 86 - *Condition to apply where telecommunication lines and power lines are carried on same supports:***

- (1) Every overhead telecommunication line erected on supports carrying a power line shall consist of conductors each having a breaking strength of not less than 270 kg.(600 lb.)
- (2) Every telephone used on a telecommunication line erected on supports carrying a power line shall be suitably guarded against lightning and shall be protected by cut-outs.
- (3) Where a telecommunication line erected on supports, carrying a high or extra-high voltage power line, arrangement shall be made to safeguard any person using the telephone against injury resulting from contact, leakage or induction between such power and telecommunication lines.

**Rule 87 *Lines crossing or approaching each other :***

- (1) Where an overhead line crosses or is in proximity to any telecommunication line, either the owner of the overhead line or the telecommunication, whoever lays his line later, shall arrange to provide for protective devices or guarding arrangements in a manner laid down in the Code of Practice or the guideline prepared by the Power and Telecommunication Co-ordination Committee and subject to the provisions of the following sub rules.
- (2) When it is intended to erect a telecommunication line or an overhead line which will cross or be in proximity to an overhead line or a telecommunication line, as the case may be the person proposing to erect such line shall give one month's notice of his intention to do so along with the relevant details or protection and drawings to the owner of the existing line.
- (3) Where an overhead line crosses or is in proximity to another overhead line, guarding arrangement shall be provided so as to guard against the possibility of their coming into contact with each other.
- (4) A person erecting or proposing to erect a line which may cross or be in proximity with an existing line, may normally provide guarding arrangement on his own line or require the owner of the other overhead line to provide guarding arrangement as referred to in sub-rule (3).

- (5) In all cases referred in the preceding sub-rule the expenses of providing the guarding arrangements or protective devices shall be borne by the person whose line was last erected.
- (6) Where two lines cross, the crossing shall be made as nearly at right angles as the nature of the case admits.
- (7) The guarding arrangement shall ordinarily be carried out by the owner of supports on which it is made and he shall be responsible for its efficient maintenance.
- (8) All work require to be done by or under this rule shall be carried out to the satisfaction of the Inspector.

**Rule 88- Guarding :**

- (1) Where guarding is required under these rules the provisions of sub-rules (2) to (4) shall apply.
- (2) Every guard-wire shall be connected with earth at each point at which its electrical continuity is broken.
- (3) Every guard-wire shall have an actual breaking strength of not less than 635 kg. (1,400 lb.) and if made of iron or steel shall be galvanized.
- (4) Every guard-wire or cross-connected system of guard-wires shall have sufficient current carrying capacity to ensure the rendering dead, without risk of fusing of the guard-wire or wires till the contact of any live wire has been removed.

**Rule 89 - Service lines from overhead lines :-** No service lines or tapping shall be taken of and overhead line except at a point of support.

**Rule 90 Earthing:**

- (1) All metal supports of overhead lines and metallic fitting attached thereto, shall be permanently and efficiently earthed. For this purpose a continuous earth wire shall be provided and securely fastened to each pole and connected with earth ordinarily at three points in every Kilometer the spacing between the points being as nearly equidistant as possible. Alternatively, each support and metallic fittings attached thereto shall be efficiently earthed.

- (IA) Metallic bearer wire used for supporting immediate wire follow and medium voltage overhead / service line shall be efficiently earthed or insulated.
- (2) Each stay-wire shall be similarly earthed unless an insulator has been placed in it at height, not less than 3.0 metres ( 10 feet) from the ground.

**Rule 91 - Safety and protective devices:**

- (1) Every overhead line not being suspended from a dead bearer wire and not being covered with insulating material and not being trolley-wire erected over any part of street or other public place or in any factory or mine or on any consumer's premises shall be protected with devices approved by the Inspectors for rendering the line electrically harmless in case it breaks.
- (2) An Inspector may, by notice in writing require the owner of any such overhead line wherever it may be erected to protect it in the manner specified in sub-rule (1).
- (3) The owner of every high and extra-high voltage overhead line shall make adequate arrangements to the satisfaction of the Inspector to prevent unauthorized persons from ascending any of the supports of such overhead line without the aid of a ladder or special appliances.

**Rule 92 - Protection against lightning:**

- (1) The owner of every overhead line which is so exposed as to be liable to injury from lightning shall adopt efficient means for diverting to earth any electrical surges due to lightning.
- (2) The earthing lead for any lightning arrestor shall not pass through any iron or steel pipe, but shall be taken as directly as possible from the lightning arrestor to a separate earth electrode and / or junction of the earth mat already provided for the high and extra high voltage sub-station subject to the avoidance of bends wherever practicable.

Note:- A vertical ground electrode shall be connected to this junction of . the earth mat. "

**CHAPTER XI-MISCELLANEOUS:**

**Rule 137 - Mode of entry -** All persons entering in pursuance of the Act of these rules, any building which is used as a human dwelling place of worship shall in making such entry, have due regard, so far as may be compatible with the exigencies of the purpose for which such entry is made to the social and religious usages of the occupant of the building entered.

**Rule 138 - Penalty for breaking seal:** any seal referred to in that rule is broken Where in contravention of rule 56,

- (a) The person breaking the seal shall be punishable with fine which may extend to two hundred Rupees, and
- (b) The consumer when he has not himself broken the seal shall be punishable with fine which may extent fifty Rupees unless he proves that he used all reasonable means in his power to ensure that the seal should not be broken.

**Rule 138 - A - Penalty for breach of rule 44 - A:** Where in contravention of rule 44. - A, any person responsible for the generation, transformation, transmission, conversion, distribution, supply or use of energy fails to report to the Inspector and other authorities concerned the occurrence of accidents, such person shall be punishable with fine which may extend to three hundred Rupees.

"140 Penalty for breach of rule-82 (a) where no notice is given under rule 82(1) or the amount of estimate as demanded under rule 82 (2) is not deposited, both the persons proposing and the contractor engaged for erecting a new building or structure whether permanent or temporary or for making in or upon any building or structure any permanent or temporary addition or alterations, shall be deemed to have committed a breach of rule 82 (1) and shall be punishable with a fine which may extend to Three Hundred Rupees;

(b) If any person, commences or continues work in contravention of rule 82(3), in or upon any such building, structure, flood bank, road or carries out addition or alteration their to, the person contravening the same shall be punishable with a fine which may extend to Three Hundred Rupees.

In addition to this the supplier shall after obtaining the concurrence of the Inspector discontinue the supply, if any, to such building structure, flood bank, or road, etc., but only after giving forty-eight hours notice to the person concerned in writing of disconnection of supply and shall not commence the supply until he and the Inspector are satisfied that the cause has been removed. "

**Rule-140 - A** Penalty for breach of rule 77, 79 or 80- where a person irresponsible for any construction which is or which results in contraventions of the provisions of rule 77, 79 or 80, he and the contractor whom he employ s shall be punishable with a fine which may extend to Three Hundred Rupees, and in the case of continuing breach, with a further daily fine which may extend to Fifty Rupees.

**Rule 141- Penalty for breach or rule** - Any person other than an Inspector (or any officer appointed to assist the Inspector) who, being responsible for the observance of any of these rules commits a breach thereof: shall be punishable for every such breach with fine which may extend to Three Hundred Rupees, and in the case of a continuing breach with a further fine which may extend To fifty Rupees, for every day after first during which the breach has continued.

**Table - 1**  
**Current Ratings for Flexible cables other than flexible cords insulated with VIR or PVC (copper)**

Nominal area	Number of wires in conductor each of diameter.								Maximum allowable resistance at 20° C (68°F) for tinned wires		Current rating for vulcanized rubber insulated cables (subject to voltage drop)		Approximate voltage drop per 10 metre run with current in previous columns	
	Inch <sup>2</sup>	mm <sup>2</sup>	0.010 inch	0.01181 inch	0.012 inch	0.01772 inch	0.018 inch	0.029 inch	0.02953 inch	Ohm/1000 yards	Ohm/km	D.C. or Singlephase A.C. twin Core	Three Phase A.C. three core	Twin Core.
(1)	(2)	(3)	(4)	(5)	(6)	(7)	(8)	(9)	(10)	(11)	(12)	(13)	(14)	(15)
0.15	..	..	..	1,358	..	610	235*	..	0.1720	0.1880	151	132	0.61	0.47
..	120	..	..	..	755	..	..	272	0.1434	0.1568	174	152	0.59	0.44
0.02	..	..	..	..	..	810	312*	..	0.1290	0.1420	183	160	0.56	0.42
..	150	..	..	..	943	..	..	340	0.1148	0.1255	201	180	0.54	0.42
..	185	..	..	..	1,163	..	..	419	0.0931	0.1018	231	205	0.50	0.39
0.3	..	..	..	..	..	1,248	481*	..	0.0841	0.0919	238	..	0.47	..
..	240	..	..	..	1,509	..	..	544	0.0717	0.0784	271	..	0.46	..
0.4	..	..	..	..	..	1,677	646*	..	0.0625	0.0684	286	..	0.42	..
..	300	..	..	..	1,886	..	..	679	0.0574	0.0628	315	..	0.43	..
0.5	..	..	..	..	..	2,057	792*	..	0.0510	0.0558	330	..	0.40	..
..	400	..	..	..	2,515	..	..	906	0.0431	0.0471	365	..	0.30	..

\* Conductor sizes for trailing cables for mines and quarries (BSS 708 and BSS 1116).

Conductor data based on BSS 7/1953, ISS 344/1953

Ratings are based on Table 26 of the I.E.E. Regulation (13th Edition).

**Table - 2**  
**Estimated current ratings for copper and aluminum conductors vulcanised rubber, PVC or Polythene Insulated cables (single, Twin, Three and Four Core)**

Item	Standard Copper Conductor		Continuous Current rating (subject to voltage Drop)			One twin core DC or AC Amp.	One 3 core 4 cable balanced 3 phase Amp.	Standard Aluminium Conductor	
	Area (Sq. Inches)	Strand/ Inches	In conduit or casing (2 single core cables Amp.	Bunched in free air or open trench. 2 single core cables Amp.	3 or 4 single core cables Amp.			Area (Sq.mm.)	Strand/ mm.
(1)	(2)	(3)	(4)	(5)	(6)	(7)	(8)	(9)	(10)
1	0.0015	1/044	5	5	5	5	5		
2	0.002	3/029	10	10	10/9	10	8/7	1.5	1/1.40
3	0.003	3/036	15	15	13/12	15	10/11	2.5	1/1.80
4	0.0045	7/029	20	20	15	20	15	..	..
5	..	..	20	20	17	20	14	4	1/2.24
6	..	..	27	27	24	27	19	6	1/2.80
7	0.007	7/036	28	28	25	28	20	..	..
8	..	..	34	34	31	34	24	10	1/3.55
9	0.1000	7/044	36	36	32	36	25	..	..
10	0.0145	7/052	43	43	39/38	43	30	16	7/1.70
11	0.0225	7/064	53	53	48	53	37	..	..
12	..	..	59	59	54	59	42	25	7/2.24
13	0.0300	19/044	62	62	56	62	43	..	..
14	..	..	69	69	62	69	48	35	7/2.50
15	0.0400	19/052	74	74	67	64	52	..	..

Item	Standard Copper		Continuos Current rating (subject to voltage Drop)			One twin core DC or AC Amp.	One 3 core 4 cable balanced 3 phase Amp.	Standard Aluminium Conductor	
	Area (Sq. Inches)	Strand/ Inches	In conduit or casing (2 single core cables Amp.	Bunched in free air or open trench. 2 single core cables Amp.	3 or 4 single core cables Amp.			Area (Sq.mm.)	Strand/ mm
(1)	(2)	(3)	(4)	(5)	(6)	(7)	(8)	(9)	(10)
16	..	..	91	91	82	91	62	50	7/3.00
17	0.0600	19/064	..	97	88	97	68	..	19/1.80
18	0.0750	19/072	..	123	107	115	78	..	..
19	..	..	..	134	118	118	82	70	19/2.24
20	..	..	..	153	138	135	94	95	19/2.50
21	0.1000	19/083	..	160	140	140	98	..	..
22	0.1200	37/064	..	177	158	158	100	..	..
23	..	..	..	184	170	162	114	120	37/2.06
24	0.1500	37/072	..	205	185	180	126	..	..
25	..	..	..	210	185	181	127	150	37/2.24
26	..	..	..	246	216	209	146	185	37/2.50
27	0.2000	37/083	..	250	220	218	153	..	..
28	..	..	..	290	248	240	169	225	37/2.80
29	0.2500	37/093	..	293	260	252	178	..	..
30	0.3000	37/103	..	335	295	284	199	..	..
31	..	..	..	354	302	289	202	300	61/2.50
32	0.4000	61/093	..	425	360	342	240	..	..
33	..	..	..	435	372	..	..	400	61/3.00



**Table - 3**  
**Tinned Copper Fuse Wire Table**

The following table is based on information given in the I.E. S. Regulations 13th Edition 1950 Table-21  
Approximate sizes of fuse elements composed of tinned copper wires for use in semi enclosed fuses  
The figures are an approximate guide only and the current at which the fuse will blow will depend upon the  
construction of the holder in which the wire is used.

S.W.S. (1)	Diameter in inch. (2)	Current rating of fuse in amperes (3)	Approximate fusing current (4)
40	0.0048	1.5	3
39	0.0052	2.5	4
38	0.0060	3.00	5
37	0.0068	3.5	6
36	0.0076	4.5	7
35	0.0084	5	8
34	0.0092	5.5	9
33	0.0100	6	10
32	0.0108	7	11
31	0.0116	8	13
30	0.0124	8.5	13
29	0.0136	10	16
28	0.0148	12	18
27	0.0164	13	23
26	0.0180	14	28
25	0.0200	15	30
24	0.0220	17	33
23	0.0240	20	38
22	0.0280	24	48
21	0.0320	29	58
20	0.0360	34	70
19	0.0400	38	81
18	0.0440	43	98
17	0.0480	45	106
16	0.0560	65	135
15	0.0640	73	166
14	0.0720	78	197
13	0.0800	102	230
13	0.0920	130	295

**Table - 4**  
**Flexible Cords Current Ratings and Weight Supportable Sizes 0.4 Sq. mm.**

Size of conductor flexible cords.				Approx. overall diameter.		Maximum allowable resistance at 20° C (68°F) for tinned wires.		Current ratings twin 3 core 4 core (subject to voltage drop).		Approx. voltage drop per 10 metre run.	Maximum permissible weight supported by twin flexible.	
Nominal Area		Number and Diameter of wires.		Inch.	mm	ohm/1000 yards.	ohm/km	amp.	Volts.	lb.	kg	
(1)	(2)	(3)	(4)	(5)	(6)	(7)	(8)	(9)	(10)	(11)	(12)	
0.006	-	14/.0076	14/.193	0.034	0.86	42.03	45.95	2.00	2.00	3.00	1.360	
	0.5	16/.00787	16/.200	0.037	0.95	34.25	37.46	3.30	2.70	3.30	1.500	
0.001	-	23/.0076	23/.193	0.046	1.17	25.57	27.97	5.00	3.00	5.00	2.268	
	0.75	24/.00787	24/.200	0.049	1.24	22.83	24.97	6.20	3.30	5.50	2.500	
	1.00	32/.00787	32/.200	0.052	1.31	17.13	18.73	8.90	3.60	10.00	4.500	
0.0017	-	40/.0076	40/.193	0.057	1.45	14.71	16.08	10.00	3.50	10.00	4.536	
	1.50	48/.00787	48/.200	0.065	1.64	11.42	12.49	11.20	3.00	10.00	4.500	
0.003	-	70/0.0076	70/.193	0.076	1.93	8.41	9.19	15.00	3.00	10.00	4.536	
	2.50	80/.00787	80/.200	0.082	2.08	6.85	7.49	17.40	2.80	10.00	4.500	
0.0048	-	110/.0076	110/.193	0.092	2.34	5.35	5.85	20.00	2.50	10.00	4.536	
	4.00	128/.00787	127/.200	0.104	2.64	4.31	4.72	24.20	2.50	10.00	4.50	
0.007	-	162/.0076	162/.193	0.120	3.05	3.63	3.97	25.00	2.10	10.00	4.536	

The resistances given are for straight single cores. For twisted and multicore flexible cords, an allowance not exceeding 5 percent must be added for the extra due to the lay of the cores.

- (1) Conductor sizes and resistances are from ISS : 434 - 1953.
- (2) Ratings are based on table 27 of I.E.E. Regulation (13th Edition).

**Table - 5**  
**Typical Design or RCC Poles**

Serial Number	Length of pole in Metres	Section in mm		Reinforcements	Equivalent safe working load at 0.303 m (i.e. one foot) from top		Total weight of pole in kg.	Use
		At top	At bottom		Due to wind on conductor in kg	Due to wind on face of pole in kg		
(1)	(2)	(3)	(4)	(5)	(6)	(7)	(8)	(9)
1	9.14 (30 ft.) special	127x102 (5"x4")	293x153 (11.5"x6")	4 rods of 20mm dia. at bottom (two nos. of bottom 7.72m on diametrically opposite sides and the other two of bottom 7.4 m length) 4 rods of 12 mm dia at top (2 nos. of 2.15 M and 2 nos. of 2.45 M length).	210.46	45.81	618.2	32 KV lines of station structure
2	9.14 (30 ft.)	127x102 (5"x4")	229x153 (9"x6")	4 rods 20 mm dia. (Two nos. upto 7.1 M from bottom and two nos. upto 7.4 M from bottom. 4 rods of 12 mm dia. at top (2 nos. of 3.05 M and 2 nos. of 2.44M).	104.33	45.36	506	33 KV lines
3	8.23 (27 ft.)	115x115 (4.5"x4.5")	254x115 (10"x4.5")	4 rods of 16 mm dia. for the centre length of pole.	90.72	40.82	407	22 KV 11 KV and 400 volts lines.
4	7.32 (24 ft.)	148x112 (5.8"x4.4")	229x153 (9"x6")	4 rods of 12 mm dia one at each corner for the entire length. Two rods of 12 mm dia. one on each face for the bottom 3.34 M height only.	90.72	40.82	450	11 KV and 400 volts lines.

NOTE :- 1. Factor of safety of 2.5 for spun or vibrated concrete poles and 3.0 for other concrete pole crippling load are adopted.

2. The poles are designed such that they will not fail due to crushing of concrete on the compression side.

The cement concrete for the poles generally of proportion 1:1.5:3 using 12 to 16 mm size of well graded hard broken stone for the coarse aggregate.

3. Wind Pressure assumed 98 kg/m on pole surface and 73.5 Kg/m on 2/3 projected area for conductors.

**Table - 6**  
**Current Carrying Capacities of overhead conductors**  
**Solid Copper Conductors**

S.W.S. number of conductors (1)	Diameter of conductor (2)	Nominal sectional area of conductor (3)	Current rating for temperature rise of	
			27.8 <sup>0</sup> c (50 <sup>0</sup> F) (4)	55.5 <sup>0</sup> C (100 <sup>0</sup> F) (5)
	INCH	Sq. INCH	AMPS	AMPS
.. .. .	0.158	0.0129	37	50
.. .. .	0.144	0.0163	44	60
.. .. .	0.160	0.0201	52	70
.. .. .	0.176	0.0243	58	81
.. .. .	0.192	0.0290	68	92
.. .. .	0.212	0.0353	78	107
.. .. .	0.232	0.0423	91	122
.. .. .	0.252	0.0499	103	139
.. .. .	0.276	0.0598	117	158
.. .. .	0.300	0.0707	133	181
.. .. .	0.324	0.0825	150	203
.. .. .	0.348	0.0951	167	226
.. .. .	0.372	0.109	184	250
.. .. .	0.400	0.1257	205	278

This table refers to situation where the initial temperature of the air is 49<sup>0</sup>C (120<sup>0</sup>F)

In the case of braided serial conductors, the ratings given for a temperature rise of 27.88<sup>0</sup>c (50<sup>0</sup>F) should be taken. It is also usual to this temperature for bare conductors.









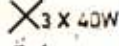















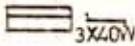

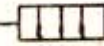



**Table - 7**  
**CURRENT RATINGS FOR ALL ALUMINUM AND A.C.S.R. BARS CONDUCTORS**

Conductor size	Maximum continuous current rating for temperature rise over an ambient of 40 <sup>0</sup> c in amps.			
	25 <sup>0</sup> c	For temperature rise of		
(1)	(2)	30 <sup>0</sup> c	50 <sup>0</sup> c	
(1)	(2)	(3)	(4)	
Aluminum conductors				
1, 7 / .0772 in - 7/1.96 mm	..	95	100	125
2, 7 / .0975 in - 7/2.44 mm	..	125	130	160
3, 7 / .1093 in - 7/2.79 mm	..	150	160	195
4, 7 / .138 in - 7/3.40 mm	..	200	210	270
A.C.S.R. conductors				
5, 7 / .083 in - 7/2.11 mm	..	100	110	137
6, 7 / .093 in - 7/2.36 mm	..	120	130	152
7, 7 / .102 in - 7/2.59 mm	..	130	140	170
8, 7 / .118 in - 7/3.00 mm	..	160	170	200
9, 7 / .144 in - 7/3.66 mm	..	188	210	260























97-53-134

**APPENDIX - B**  
**Architectural Symbols For Electrical Installations In Buildings**

<b>1. WIRING</b>		
1	GENERAL WIRING	—
2	WIRING ON THE SURFACE	M M
3	WIRING UNDER THE SURFACE	W W
<b>2. WIRING IN CONDUIT</b>		
4	CONDUIT ON SURFACE	M M
5	CONCEALED CONDUIT	W W
6	WIRING GOING UPWARDS	○
7	WIRING GOING DOWNWARDS	○
8	WIRING PASSING VERTICALLY THROUGH A ROOM	○
<b>3. FUSE BOARD</b>		
<u>Lighting Circuit Fuse-Boards</u>		
9	MAIN FUSE-BOARD WITHOUT SWITCHES	■
10	MAIN FUSE-BOARD WITH SWITCHES	■
11	DISTRIBUTION FUSE-BOARD WITHOUT SWITCHES	▨
12	DISTRIBUTION FUSE-BOARD WITH SWITCHES	▨
<u>Power Circuit Fuse-Boards</u>		
13	MAIN FUSE-BOARDS WITHOUT SWITCHES	■
14	MAIN FUSE-BOARDS WITH SWITCHES	■
15	DISTRIBUTION FUSE-BOARD WITHOUT SWITCHES	▨
16	DISTRIBUTION FUSE-BOARD WITH SWITCHES	▨
<b>4. SWITCHES AND SWITCH OUT LETS</b>		
<u>One Way Switch</u>		
17	SINGLE POLE	○
18	TWO POLE	○
19	THREE POLE	○
20	SINGLE POLE FULL SWITCH	○
21	MULTIPOSITION SWITCH [FOR DIFFERENT DEGREES OF LIGHTING]	○
22	TWO WAY SWITCH	○
23	INTERMEDIATE SWITCH	○
24	PERIOD LIMITING SWITCH	○
25	TIME SWITCH	○
26	PENDANT SWITCH	○
27	PUSH BUTTON	○

28 LUMINOUS PUSH BUTTON	
29 RESTRICTED ACCESS PUSH BUTTON	
<u>5. SOCKET OUTLETS</u>	
30 SOCKET - OUTLET. 5A	
31 SOCKET-OUTLET. 15A	
32 COMBINED SWITCH & SOCKET-OUTLET. 5A	
33 COMBINED SWITCH & SOCKET-OUTLET. 15A	
34 INTERLOCKING SWITCH & SOCKET-OUTLET. 15A	
35 INTERLOCKING SWITCH & SOCKET OUTLET. 5A	
<u>6. LAMPS AND LIGHTING APPARATUS</u>	
36 LAMP OR OUTLET FOR LAMP	
37 GROUP OF THREE 40W LAMPS	
38 LAMP MOUNTED ON A WALL	
39 LAMP MOUNTED ON A CEILING	
40 COUNTER WEIGHT LAMP FIXTURE	
41 CHAIN LAMP FIXTURE	
42 ROD LAMP FIXTURE	
43 LAMP FIXTURE WITH BUILT IN SWITCH	
44 LAMP FED FROM VARIABLE VOLTAGE SUPPLY	
45 EMERGENCY LAMP	
46 PANIC LAMP	
47 BULK HEAD LAMP	
48 WATER-TIGHT LIGHTING FITTING	
49 BATTEN LAMP HOLDER	
50 PROJECTOR	
51 SPOT LIGHT	
52 FLOOD LIGHT	
53 FLOURESCENT LAMP	
54 GROUP OF THREE 40W FLOURESCENT LAMPS	
<u>7 ELECTRICAL APPLIANCES</u>	
55 GENERAL	
Note:-If Necessary Use Designation To Spscify	
56 HEATER	
57 STORAGE TYPE ELECTRIC WATER HEATERS	
<u>8 BELLS BUZZERS AND SIRENS</u>	
58 BELL	
59 BUZZERS	

34-39-136

	60 SIREN	
	61 HORN OR HOOTER	
	62 INDICATOR (A)*N"INSERT NUMBER OF WAYS)	
FANS	63 CEILING FAN	
	64 BRACKET FAN	
	65 EXHAUST FAN	
	66 FAN REGULATOR	
	<u>9 TELE COMMUNICATION APPARATUS</u>	
	67 SOCKET-OUTLET FOR TELECOMMUNICATION	
	68 AERIAL	
	69 LOUP SPEAKER	
	70 RADIO RECEIVING SET	
	71 AMPLIFYING EQUIPMENT	
	72 TELEVISION RECEIVING SET	
	73 CONTROL BOARD ( FOR PUBLIC ADDRESS SYSTEM)	
	<u>10 CLOCKS</u>	
	74 SYNCHRONOUS CLOCK	
	75 IMPULSE CLOCK OUTLET	
	76 MASTER CLOCK OUTLET	
	<u>11 FIRE ALARMS</u>	
	77 MANUALLY OPERATED FIRE ALARM	
	78 AUTOMATIC FIRE DETECTOR SWITCH	
	79 BELL CONNECTED TO FIRE ALARM SWITCH	
	80 FIRE ALARM INDICATOR	
	<u>12 EARTHING</u>	
	81 EARTH POINT	



**26-233**

**SECTION – III**

**CHAPTER – 41**

**DRILLING OF TUBEWELLS**

APPEDIX - C

SAFETY PROCEDIJRE.

1. **General:**

1.1 While the Indian Electricity Rules, 1956 as amended up to date are to be followed in their entirety, particular attention is drawn to the various clauses indicated in Appendix "A". Any installation or portion of installation, which does not comply with these rules, should be got rectified immediately.

1.2 The detail instruction on safety procedures given in IS. 5216-1969 (with amendment No.1) "Code for safety procedures and Practices in Electrical Works" shall be strictly followed. Safety instruction for working on low and medium voltage mains and apparatus and on high voltage mains and apparatus are given in 2 and 3.

1.3 It shall be the responsibility of the Section Officer to see the control switches and distribution boards duly marked, the distribution diagrams of sub-stations prominently displayed, sub-stations premises, main switch room and Distribution Board enclosures are kept clean. Particular care should be taken to prevent the sub-stations to be used as store for inflammable materials, broken furniture, wastage materials, etc.

1.4 No inflammable materials shall be stored in places other than the rooms specially constructed for this purpose under the Indian Explosive Act.

If such storage is unavoidable, it should be allowed only for a short period and in addition special precaution such as cutting of the supply to such places at normal times, storing materials away from wiring and switch boards, giving electrical supply for a temporary period with the permission of section officer shall be taken.

1.5 Rubber or insulating mats should be provided in front of main switch board or any other control equipments of medium voltage and above.

1.6 Protective and safety equipments such as rubber gauntlets or gloves, earthing rods, linemen belts, portable articles respiration apparatus, etc., should be provided in each sub-station, enquiry office and important installations. Where electric welding or such other nature of work is undertaken, goggles shall also be provided.

1.7 Necessary number of caution boards such as If Man on line, Don't switch

on If should be readily available in such sub-stations, enquiry office and important installations. A list of persons authorized to work on live mains and apparatus and issue work permits shall be kept in the switch rooms and important installations.

## 26-235

1.8 Standard First Aid Boxes containing materials as prescribed by St. John Ambulance Brigade of Indian Red Cross should be provided in each sub-stations, enquiry office and important installations and should readily be available.

1.9 Periodical examination of the First Aid facilities and protective and safety equipments provided at various installations shall be -under taken for their adequacy and effectiveness and proper record maintained.

1.10 Charts (one in English and one in Regional Language) displaying methods of giving artificial respiration to a recipient of electric shock should be prominently displayed at appropriate places. Some important methods are described in 4.

1.11 A chart containing the names, addresses and telephone numbers of authorised medical practitioners, Hospitals, Fire Brigade. and also of the officers in executive charges shall be displayed prominently along with the First Aid Box.

1.12 Executive Engineers should take immediate steps to train supervisory and. authorised persons of the Engineering Staff VIZ., Assistant Engineers, Junior Engineers, Foreman, Electricians, Wireman in the First. Aid Practices including various methods of artificial respiration with the help of local authorities such as Fire Brigade, St. John Ambulance Brigade and Indian Red Cross or other recognised Institutions equipped to impart such training as prompt rendering of artificial respiration can save life at times of electric shock.

1.13 All new recruits should be given such First Aid Training immediately after appointment.

1.14 All supervisory and authorised persons of the Engineer Staff should be deputed for refresher course in First Aid Training after every two years.

1.15 Details of preventive maintenance to be undertaken shall be in accordance with the schedule given in Appendix 'P'. All preventive maintenance works shall be planned as for as possible and names of persons who are assigned to these works should be entered in a log-book..

1.16 Electric wiring and control switches should be periodically inspected and any defective wiring, broken parts of switches which will expose live parts should be replaced immediately to make the installation safe for the user.

1.17 Reports indicating details of preventive maintenance works done should be kept in a register by each Section Officer (Electrical) and should bear signatures of Assistant Engineer or Executive Engineer by way of checks.

## 26-236

1.18 No work shall be under taken on live Installations or on installations which could be energised unless one another person is present to immediately isolate the electric supply in the case of any accident and to render First Aid if necessary.

1.19 No work on live L.T. bus bar or pedestal switchboard in the sub-station should be handled by a person below the rank of wireman and such work should preferably be done in the presence of Section Officer (Electrical) in charge of the work.

1.20 When working on or near live installations suitably insulated tools should be used and special care should be taken to see that those tools accidentally do not drop on live terminals causing shock or dead short.

1.21 The electrical switchgears and distribution boards should be clearly marked to indicate the areas being controlled.

1.22 Before starting any work on the existing installation, it should be ensured that electric supply to that portion in which work is Undertaken is preferably cutoff: precautions taken like displaying "Men at work", caution boards on the controlling switches, removing fuse carrier from these switches, these fuse carriers being kept with the person working on the installation, etc., taken against accidental energisation and " Permit to Work" obtained from the Section Officer-in-Charge (No work on H. T. main should be undertaken unless it is made dead and discharged to earth with an earthing lead of appropriate size. The discharge operation shall be repeated several times and the installation connected to earth positively before any work is started.

1.23 Before energising 'on' an installation after the work is completed, it should be ensured that all tools have been removed and accounted, no person is present inside any enclosure of the switch board, etc., any earthing connection made for doing the work has been removed, "Permit to Work" received back duly signed by the person to whom it was issued in token of having completed the work and the installation being ready for re-energising and " Men at Work" caution boards removed.

1.24 In case of electrical accident and shock, the electrical installations on which accident occurred should be switched off immediately and the affected person should be immediately removed from the live installation by pulling with the help of his coat, shirt; wooden rod, broom handle or with any other dry cloth or paper. He should be removed from the place of accident to a nearby safe place and artificial respiration continuously given as contained in I.S.I. Code and standard prescribed by St. John Ambulance Brigade or Fire Brigade.

1.25 While artificial respiration on the affected person is started immediately, help of Fire Brigade and Medical Practitioner should be called for and artificial respiration continued uninterrupted until such help arrives.

1.26 These instructions should be explained in Hindi to those staff who do not understand English.

1.27 Executive Engineers should take particular care to ensure that these instructions are imparted to the existing staff as well as new entrants.

**2. Safety Instructions for Working on Low and Medium Voltage Mains and Apparatus.**

**2.1 *Work on Dead Low and Medium Voltage Mains and Apparatus:***

Unless a person is authorised to work on live low and medium voltage mains and apparatus, all mains and apparatus to be worked upon shall be isolated from all sources of supply before starting the work, proved dead, earthed and short-circuited. For earthing and short-circuiting, only recognised methods should be used. Measures shall be taken against the inadvertent energising of the mains and apparatus.

**2.2 *Work on live Low and Medium Voltage Mains and Apparatus:***

Only competent, experienced and authorised persons shall work on live mains and apparatus and such persons should take all safety measures as may be required under the Indian Electricity Rules, 1956.

2.2.1 Warning board shall be attached on or adjacent to the live apparatus and at the limits of the zone in which work may be carried out.

2.2.2 Immediately before starting work, rubber gauntlets, if used, shall be thoroughly examined to see whether they are in sound condition. Under no circumstances shall a person work with unsound gauntlets, mats, stools platforms or other accessories and safety devices.

2.2.3 No live part should be within safe distance of a person working on live low and medium voltage mains so that he does not come in contact with it unless he is properly protected.

2.3 ***Testing of Main and Apparatus with Low Voltage:*** No person shall apply test voltage to any mains unless he has received a permit - to - work and has warned all persons working on the mains of the proposed application of test voltage. If any part, which will thus become alive is exposed, the person - in - charge of the test shall take due precautions to ensure that the exposed live portion does not constitute danger to any person. It should also be ensured before the application of test voltage, that no other permit -to - work has been issued for working on this mains.

2.4 **Connecting Dead Mains to live Mains:** When dead mains are connected to live mains, all connections to the live parts shall be made last, and in all cases the phase sequence should be checked to ensure that only like phases are connected together. Before inserting fuses or links in a feeder or distribution pillar controlling the cable on which a fault has been cleared, each phase shall first be connected through a test switch fuse.

### 3. Safety Instructions for Working on High Voltage Mains and Apparatus.

3.1 **General:** All high voltage mains and apparatus shall be regarded as alive and a source of danger and treated accordingly unless it is positively known to be dead and earthed.

3.1.1 No person shall work on, test or earth high voltage main or apparatus unless covered by a permit-to-work and after providing the mains dead except for the purpose of connecting the testing apparatus, etc., when especially designed for connecting to the live parts.

3.1.2 The operations of proving dead, earthing and short-circuiting of any mains shall be carried out only by an authorised person under the instructions of the person in charge of maintenance.

3.1.3 While working on high voltage mains, the following precautions shall be taken :

(a) No person, after receiving a permit-to-work, shall work on, or in any way interfere with any high voltage main or conduits or trough containing a high voltage main except under the personal instructions and supervision on the site of work, of competent person;

(b) When any high voltage mains is to be earthed, the procedure prescribed in 3.4.6 shall be scrupulously followed; and

(c) The earths and short-circuits, specified on permit to work shall not be removed or interfered with except by authority from the person-in-charge of the work.

3.2 **Minimum Working Distance:** No person shall work within the minimum working distance from the exposed live high voltage mains and apparatus. The minimum working distance depends upon the actual voltage. It does not apply to operations carried out on mains and apparatus which are so constructed as to permit safe operation within these distances.

3.3. **Isolation of High Voltage Mains:** Isolation of high voltage main shall be effected by the following methods:-

- (a) The electrical circuit shall be broken only by authorised persons by disconnecting switches, isolating links, unbolting connections or switches which are racked out. Where possible, the isolation should be visibly checked and;
- (b) Where the means of isolation are provided with a device to prevent there reclosure by unauthorised persons, such a device shall be used.

3.4 **Devices for Proving High Voltage Mains and Apparatus Dead.**

3.4.1 High voltage neon lamp contact indicator rods are often used for proving exposed high voltage mains and apparatus dead. Each rod is fitted with indicating neon tube or other means which glows when the contact end of the rod comes in contact with exposed live high voltage parts. Each rod is clearly marked for the maximum voltage on which it may be safely used and shall not, under any circumstances, be used on higher voltages.

3.4.2 High voltage contact indicator and phasing rods are provided for phasing and proving exposed high voltage main and apparatus dead. A set consists of two rods connected in series by a length of insulated cables. Both rods are fitted with contact tips and' indicating tubes. When the contact tip of one rod is applied to exposed live high voltage parts and that of the other to earth or other exposed live high voltage parts provided there is sufficient voltage difference between the two, the indicating tubes should glow. Each set of rods is normally marked for the maximum voltage on which it may be used and shall not, under any circumstances, be used for higher voltages.

3.4.3 **Use of High Voltage Contact Indicator and Phasing Rods :** While using the high voltage contact' indicator and phasing rods for providing the high mains or apparatus dead following precautions should be taken :

- (a) Ensure that the rod is clean and dry;
- (b) Check the rod by applying it to known live parts of the correct voltage, the indicating tube shall glow;
- (c) Apply the rod to each phase required to be proved dead, the indicating tube shall not glow. Be very careful to be in position to see the glow, if any, appearing in the indicating tube; and

## 26-240

- (d) Again check the rod by applying it to live parts as in (b) above, again the indicating tubes shall glow.

**Note 1-** All the above operation shall be carried out at the same place and at the same time, if no live high voltage parts are available on the site; rods up to 11 KV may be tested by applying them to the top of spark plug in a running motor car engine. If the rod is in order, the indicating tube will glow each time the plug sparks. Therefore, the glow will be intermittent, but the indicating tube should glow on this test or the rod is useless as a means of proving the mains or apparatus dead.

**Note 2-** The rod should be tested both before and after the use.

3.4.4 *Testing and Marking of Devices of Proving High Voltage Mains and Apparatus Dead: -*  
It shall be ensured that all devices for proving high voltage mains and apparatus dead are marked clearly with the maximum voltage for which they are intended and should be tested periodically as recommended in 3.4.3.

3.4.5 *Identification of Cables to be Worked Upon:* A high voltage cable shall be identified as that having been proved dead prior to cutting or carrying out any operation which may involve work on or movement of the cable. A non-contact indicating rod, induction testing set or spiking device may be used for proving the cable dead.

3.4.6 *Earthing and Short-Circuiting High Voltage Mains :*

3.4.6.1 High voltage mains shall not be worked upon unless they are discharged to earthed after making them dead and earthed and short-circuited with earthing and short-circuiting equipment adequate to carry possible short-circuit currents and specially meant for the purpose. All earthing switches wherever installed should be locked up.

3.4.6.2 If a high voltage cable is required to be cut, a steel wedge shall be carefully driven through it at the point where it is to be cut of preferably by means of spiking gun of approved design.

3.4.6.3 After testing the high voltage cable with D.C. voltage, the cable shall be discharged through a 2 megohms. resistance and not directly, owing to dielectric absorption which is particularly permanent the D.C. voltage testing of high voltage cables. The cable shall be discharged for a sufficiently long period to prevent rebuilding up of voltage.



## 26-241

3.4.6.4 The earthing device when used shall be first connected to an effective earth. The other end of the device shall then be connected to the conductors to be earthed.

3.4.6.5 Except for the purpose of testing, phasing, etc., the earthing and short circuiting device shall remain connected for the duration of the work.

3.4.7 *Removing the Earth Connections:* On completion of the work, removal of the earthing and short-circuiting devices shall be carried out in the reverse order to that adopted for placing them (See 3.4.6), that is, end of the earthing device attached to the conductors of the earthed mains or apparatus shall be removed first and the other end connected to earth shall be removed last. The conductor shall not be touched after the earthing device has been removed from it.

3.4.8 *Safety Precautions for Earthing:* The precaution mentioned 3.4.8.1 to 3.4.8.5. should be adopted to the extent applicable and possible.

3.4.8.1 Examining earthing devices periodically and always prior to their use.

3.4.8.2. Use only earthing switches or any other special apparatus where provided for earthing.

3.4.8.3 Verify that the circuit is dead by means of discharging rod or potential indicator of approved type. The indicator itself should first be tested on a live circuit before and after the verification.

3.4.8.4 Earthing should be done in such a manner that the person doing the job are protected by earth connections on both sides of their working zones.

3.4.8.5 All the three phases should be effectively earthed and short-circuited though work may be proceeding on one phase only.

3.4.9 Working on mains where visible isolation can not be carried out, where the electrical circuit can not be broken visibly as set out in 3.3 the circuit may be broken by two circuit opening devices one on each side of the work zone, where duplicate feed available or one circuit opening device where duplicate feed is not available provided the following conditions are fulfilled:

- (a) The position of the contacts of the circuit opening device(s) - 'Open 'or 'closed '- is clearly indicated by the position of the opening handle or by signal lights or by other means.
- (b) The circuit opening device( s) can be locked mechanically in the open position.

- (c) The main and apparatus to be worked on are adequately earthed and short-circuited between the circuit opening device and the position of the work.
- (b) In cases, where duplicate feed is available, both the circuit opening devices are in series between the mains to be worked on and any source of supply.

3.4.9.1 The circuit opening devices mentioned in 3.4.9 shall be locked in the open position before the work on the mains and apparatus is commenced. The locking devices shall be removed only by competent person and not until the work has been completed, any short-circuiting and earthing removed and the permit-to-work form duly returned and cancelled.

3.4.10 *Work on High Voltage Mains With two or more Sections:* When the mains to be worked upon are to be divided into two or more sections, the provisions of 3.3,3.4.6 and 3.4.9 shall be observed with regard to each section.

4. **First-Aid in Case of Electric Shock:**

4.1 ***Helger Nielson Method of Artificial Respiration :***

- 1. Protect yourself with dry insulating material.
- 2. Break the circuit by opening the power switch and release the victim
- 3. Do not touch the victim with your bare hands until the circuit is broken.
- 4. Lay patient face downwards with forehead resting on the hands placed one above the other.
- 5. Remove the false teeth, tobacco or gum from patient's mouth; make sure the



tongue is free by firm blows between the shoulders with the flat of hand.

- 6. Kneel on one knee at the patient's head one foot by the patient's elbow..

## 26-243

7. Place palms of your hands on patient's shoulder blades (See-A).
8. Rock forward until arms are vertical the pressure should be light and without force (22.30 lbs. is sufficient); this should take 2.5 seconds (See-B).

9.



Release the pressure by allowing the hands to slide down the arms to the patient's elbows (Approx. 1 Second) then raise the patient's arms and shoulder slightly pulling at the same time by swinging backwards (Approx.-2.5 Seconds). (See-C). Lower the patient's arms. (See-D) and return your hands to the patient's shoulder blades.

10. Repeat the movements taking seven seconds for each complete respiration.
  11. While artificial respiration is continued have some one else :
    - (a) Loosen patient's clothing.
    - (b) Send for a Doctor.
    - (c) Keep patient warm.
  12. If patient stops breathing continue artificial respiration. Four hours or more may be required.
  13. Do not give liquids until patient is conscious.
- 4.2 ***Schafer's method of artificial respiration :***
- (1) Protect yourself with dry insulating material.
  - (2) Break the circuit by opening the power switch and release the victim.
  - (3) Don't touch victim with your bare hand until the circuit is broken.
  - (4) Lay patient on stomach one arm extended the other bent at elbow. Turn face outward resting on forearm.



- (5) Remove false teeth tobacco or gum from patient's mouth.
- (6) Kneel on one side of patient's thighs facing his head with knees and hips bent. (See-A).
- (7) Place palms of your hand on patient's back with little fingers just touching the elbow ribs.
- (8) With arms straight swing forward gradually bringing the weight of your body to bear upon the patient (approx. 3 seconds).
- (10) Repeat twelve times per minute taking 5 seconds for every complete double movement.
- (11) While artificial respiration is continued have some one else:
  - (a) Loosen patient's clothing.
  - (b) Send for Doctor.
  - (c) Keep patient Warm.
12. If patient stops breathing continue artificial respiration. Four hours or more may be required.
13. Do not give liquids until patient is conscious.

(These instructions given herein or approved by the Royal Life Saving Society who are of the opinion that the Holger Niclson Method of Artificial Respiration is much more effective then the Schafer Method of the Silverster Method.)

**4.3 Direct Artificial Respiration:**

- 4.3.1 Direct Artificial Respiration (mouth-to-mouth method).
  - (1) Place victim on back immediately.
  - (2) Clear throat of water, mucus, toys, coins or food.

## 26-245

- (3) Tilt head back as far as possible.
- (4) Lift jaw up to keep tongue out of air passage.
- (5) Pinch nostrils to prevent air leakage when you blow.
- (6) Blow until you see the chest rise.
- (7) Listen for snoring and gurgling-signs of throat obstruction.
- (8) Repeat blowing 10-20 times a minute.

In the case of infants and small children tilt the head fully back surround the mouth and nose completely with your mouth. Blow with only enough force to produce a visible rise in the victims chest and no more. Repeat every 2 seconds.

Continue direct artificial respiration until victim breathes for himself or until expert help is obtained.

**4.4 Treatment for Electric Burns :** If, as result of electric shock the patient is suffering from burns the following treatment should be given without hindrance to artificial respiration:

- (a) Remove clothing locally to enable the burn to be treated but do not break blisters.
- (b) Saturate burns with the warm solution of one dessert Spoonful of bicarbonate of soda to a pint of warm water or a teaspoonful of salt to pint of warm water.
- (c) Cover with lint soaked in a similar solution and the bandage (lightly if blisters have formed).
- (d) If the above solutions are not available cover with a sterile dressing.
- (e) Warm, weak, sweet tea may be given when the patient is able to swallow.

**Appendix-D**

**Form of completion certificate.**

I/We certify that the installation detailed below has been installed by me/us and tested and that to the best of my/our knowledge and belief: it complies with Indian Electricity Rules 1956 as well as P.W.D. General specifications for Electrical works.

Electrical Installation at.....

Voltage and system of supply.....

**I. Particulars of works:**

**(A) Internal Electrical Installation.**

	Number	Total load.	Type of System of Wiring.
(i)	Light point		
(ii)	Fan point.		
(iii)	Plug point.		
(a)	3 pin 5 Amp.		
(b)	3 pin 15 Amp.		

**(B) Others.**

	Description	H.P./K.W.	Type of starting.
(a)	Motors:		
(i)			
(ii)			
(iii)			
(b)	Other plants:		
(c)	If the work involves installation of overhead line and / or underground cable;		
(a)	(i) Type and description of overhead line.		
	(ii) Total length and number of spans.		
	(iii) Number of street lights and its description.		
(b)	(i) Total length of underground cable and its size.		
	(ii) Number of joints-End joint, Tee joint. Straight through joint.		

**II. Earthing :**

- (i) Description of earthing electrode.
- (ii) Number of earth electrodes.
- (iii) Size of main earth lead.

**III. Test results:**

- (a) Insulation resistance.
  - (i) Insulation resistance of the whole system of conductor to earth-Megohms.
  - (ii) Insulation resistance between the phase conductor and neutral.
    - Between phase R and neutral / Megohms.
    - Between phase Y and neutral / Megohms.
    - Between phase B and neutral / Megohms.
  - (iii) Insulation resistance between the phase conductors in case of poly phase supply-
    - Between phase R and Phase Y / Megohms.
    - Between phase Y and phase B / Megohms.
    - Between phase B and phase R / Megohms.
- (b) *Polarity test* :- Polarity of non-linked single pole branch switches.
- (c) *Earth continuity test*. - Maximum resistance between any point in the earth continuity conductor or including metal conduit and main earthing lead-Ohms.
- (d) *Earth electrode resistance* - Resistance of each earth electrode
  - (i)..... Ohms.
  - (ii)..... Ohms.
  - (iii)..... Ohms.
  - (iv)..... Ohms.

Signature of Section Officer:

Signature of contractor:

Name and address.

Name and address.

## SECTION – III

“ CHAPTER - 41 DRILLING OF TUBEWELLS



## CHAPTER – 41 DRILLING OF TUBEWELLS

### CONTENTS

	<b>Contents</b>	<b>Page Nos.</b>
41.1	References.	41- 1
41.2	Terminology	41-2
41.3	Materials, Equipments and the Accessories.	41- 9
41.4	Site Selection and Exploration.	41 – 14
41.5	Types of Tube wells and their Construction.	41 – 17
41.6	Drilling Methods.	41 – 18
41.7	Well Logging.	41 – 20
41.8	Design of well Assembly and Lowering of Pipe Assembly.	41 – 21
41.9	Gravel Packing.	41 – 21
41.10	Development of Tubewell.	41 – 21
41.11	Measurement of Tube well Depth.	41 - 22
41.12	Measurement of Water Level.	41 - 22
41.13	Verticality and Alignment.	41 - 23
41.14	Testing for Yield and Drawdown.	41 - 25
41.15	Quality of Water.	41 - 26
41.16	Record of Chemical Analysis of Water & Details of Development and Test Report.	41 - 27
41.17	Disinfection	41 - 27

41.18	GROUTING AND scaling.	41- 27
41.19	Pump Installation.	41.27
41.20	Handing over the Tubewells by the Drilling Agency.	41.27
	Appendix – I Selection of Slot size	41.30
	Appendix – II Methods of Development.	41.32
	Appendix – III Verticality Test Report.	41.35
	Appendix – IV Test Results.	41.36
	Plates 41 – P/1 to 41 – P/17	
	Sample Drawing of Pump House	

## CHAPTER-41

### DRILLING OF TUBEWELLS

#### 41.1

#### REFERENCES

- |                          |  |
|--------------------------|--|
| IS:1239(Pt.I)<br>-1979   | Specification for mild steel tubes, tubular and other wrought steel fittings part I<br>Mild Steels tubes (with amendments NO. 1 to5) (fourth revision). (Reaffirmed<br>1985) |
| IS:2800(Pt.I)<br>-1979   | Tubewell Construction (first revision) (Reaffirmed 1985)   |
| IS:2800 (Pt.II)<br>-1979 | Tubewell testing (first revision) (Reaffirmed 1990)  |
| IS:4097-1988             | Gravel for use as pack in tubewells ( Reaffirmed 1993)   |
| IS:4270-1983             | Steel tubes used for water wells (first revision)  |
| IS:4412-1981             | Copper wires for general engineering purpose (Reaffirmed 1991)   |
| IS:5120-1977             | Technical requirements for rotodynamic special purpose pumps. (Reaffirmed<br>1991)   |
| IS:5494-1969             | Leaded brass sheets and strips for use in the manufacture of tubewell stainers   |
| IS:8110-1985             | Well screens and slotted pipes (first revision) Reaffirmed 1990 )  |
| IS:9439-1980             | Glossary of terms used in water well drilling technology (Reaffirmed 1991)   |
- Unified Schedule of Rates for Irrigation works in M.P. inforce from 1-4-1991.
- Engineer -in-Chief, Water Resources Department, Publication No, 19-Tube  
wells in Madhya Pradesh.

## 41.2 TERMINOLOGY

**Acidizing** - The process of introducing acid in to the pore space of- an acid soluble formation for the purpose of enlarging the pore space by dissolving the Surrounding formation. Acidizing also refers to the removal of encrustation nom well screens and gravel pack and dissolving cementitious materials.

**Additive** - An auxiliary agent added for conditioning of drilling fluid to obtain desired physical properties.

**Air Drilling** - The drilling process in which air is used as a medium for removal of cuttings.

**Air Line** - The small diameter vertical pipe inserted in the tubewell with or without the deduction for cleaning and developing tubewell by airlift method.

**Air Line Lubricator (also, in Line Oiler)** - An apparatus that feeds a small controllable quantity of lubricating oil into the air stream to provide lubrication for pneumatic components accessories of machines.

**Air Rotary Drilling** - A process similar to direct circulation rotary drilling except that compressed air. is used as drilling fluid instead of drilling mud.

### **Annular Space**

The space between:

- (a) Casing and wall of the hole or
- (b) Casing and wall of the hole or
- (c) Drill pipe and casing.

**Annular Velocity** - **The up hole or return velocity of fluid or air in the annulus usually expressed in metres per minute.**

**Antifoam** - An agent added to acid to prevent or retard foaming during the acid reaction.

**API (American Petroleum Institute) - Designation** - The designation given to equipment or parts of equipment standardised by the American Petroleum Institute, such as drill pipe threads.

**Aquifer** - An aquifer is a formation, group of formations, or part of a formation that contain sufficient saturated permeable material to yield significant quantities of water to wells and springs.

**Acquifuse** - **An impermeable formation neither containing nor transmitting water (e.g. Solid granite).**

**Artesian** - **Artesian is synonymous with confined artisan water and artisan water body are equivalent respectively to confined ground water and confined water body. The water level in an artesian well stands above the top of the artesian water body it taps.**

**Artesian Well** - A Well tapping a confined or artesian aquifer in which the static water level stands above the water table. The term is sometimes used to include all wells tapping confined water, in which case those wells with water level above the water table are said to have positive artesian head (pressure) and those with water level below the water table, negative artesian head.

**Bailer** - A tube fitted with a valve at its base which is lowered into a bore hole to remove cutting and water.

**Barit** - Barium sulphate, the commercial product contains small amount of iron oxide, silica and other minerals. It is used to make mud heavier.

**Baryles** - Natural barium sulphate used as a basic material for weighing agents.

**Bentonite** - A highly plastic, colloidal clay composed largely of mineral montmorillonite.

**Breakout** - The act or process of initially loosening a threaded joint.

**Bridge** - An obstruction to circulation in the annular space of the well,

**Cable Tool Percussion Drilling** - A spudding process in which drilling is carried out by lifting and dropping a heavy string of drilling tools at regular intervals, resulting in crushing or loosening rock formations. The reciprocating action of the tools mixes the crushed or loosened particles with water to form a slurry or sludge. The necessary water is put into the bore hole if no water is present in the formation being penetrated. The slurry is removed at intervals from the bore hole by means of a sand pump or a bailer.

**Casing pipe** - Piping used to support the sides of bore hole.

**Casing Shoe** - A heavy-walled steel coupling or band at the lower extremity of the casing. It clears the way for casing.

**Cat head** - An auxiliary hoisting device used for handling light loads and for alternately lifting and dropping tools such as drive block or bumper. Its use requires a line of similar wire rope carried on a separate sheave at the top of the derrick. It is also used for making and breaking the joints.

**Cementing** - **The process of placing the cement slurry to provide a seal against subsurface water.**

**Cement Plug** - The hardened cement slurry left in the lower portion of the casing and later drilled out after the cement has set.

**Cement Slurry** - A pumpable mixture of cement and water.

**Circulation, Direct (Drilling)** - The drilling fluid movement from the mud pit, through the pump, standpipe, hose, drill pipe, annular space in the hole, and settling pit back to the mud pit.

**Circulation, Reverse (Drilling)** - The drilling fluid movement from the mud pit to the annular space in the hose, drill pipe, Kelly water swivel, suction hose, centrifugal or jet pump, settling pit and back to mud pit.

**Control console** - A horizontal or vertical panel on which are grouped one of the operator's various controls.

**Crown Block** - An assembly of wireline sheaves mounted on the upper most portion of the derrick.

**Derrick** - See "Mast".

**Die Overshot** - A long tapered die of heat-treated steel designed to fit over the top of the last drill pipe and cut thread when rotated. The tool is fluted to permit the escape of metal cuttings and fluids.

**Dilution** - The use of more water in the cement slurry than is necessary to produce a pumpable slurry.

**Direct Circulation Rotary Drilling** - This process consists of drilling a borehole by means of a rotating bit and removing the cuttings by continuous circulation of drilling fluid as the bit penetrates the formation materials. The drilling fluid flows from the mud pit, through the pump, stand pipe, hose drill pipe annular space in the hole, and settling pit back to the mud pit.

**Down-the-Hole Drilling** - A method of drilling using down-the-hole hammers.

**Down-the-Hole Hammer** - A percussive air operated tool attached to the end of the drill string used in down-the-hole drilling . Tungsten carbide tipped bits are normally used with down-the-hole hammers.

**Drag Bit** - A rotary bit which has two or more cutting blades or wings with hard . faced cutting edges.

**Draw Down** - Lowering of water level caused by pumping. It is measured for a given quantity of water pumped during a specified period, of after the pumping level has stabilized.

**Draw-works** - A power - driven winch or winches, usually equipped with clutch and brake for hoisting or lowering a drilling string.

**Drill Bit** - Drilling tools deployed in drilling operations and attached at the end of the drill string.

**Drill Collar** - A heavy drill pipe used immediately above the drill bits to put weight on the drill bit and minimize deviation of the hole.

**Drill Pipe** - Special pipe, with threaded tool joints at both ends used to transmit rotation from the rotating mechanism; thrust or weight to the bit and convey fluid which removes cuttings from the hole and cools the bit.

**Driller** - A person who operates the drilling machine or rig.

**Drill String** - Components including hubs, adaptors, drill pipe, drill collar, bit, etc. joined together to form a drill string depending upon the type of rig used for drilling the hole.

**Drive Head** - A casing fastened to the top of pipe or casing to take the blow of drive weight.

**Drive pipe** - A pipe or casing driven through over-burden.

**Drive weight** - Normally used in percussion drilling to give blows on top of casing to drive it. Also called drive hammer or drive block.

**Dry Hole or Duster** - A well drilled which produces neither oil nor gas nor water of significant quantity.

**Dust Collector** - Used to control the dust and/or collect the cuttings which are discharged from the hole being drilled by air drilling.

**Dust Diverter** - Collar and hose used to divert dust and cuttings away from the operator and the machinery.

**Expansion Reamer** - A device or tool having cutters that can be expanded or contracted by hydraulic or mechanical means and used to enlarge or ream bore hole below the casing or drive pipe. Also known as adjustable or under reamer.

**Feed** - The process of applying required pressure on the cutting tool to achieve the down ward movement.

**Fish** - Debris in the hole such as broken bits, drill pipe, casing tools, etc, which may have e broken off and lodged in the hole.

**Fishing** - The act of attempting to recover a fish.

**Fishing Magnet** - A special powerful magnet attached to a rope to fish out magnetic material.

**Fishing Tap** - **A tap of heat treated steel designed to fit to the top of the lost drill pipe and cuts thread when rotated. The tap is fluted to permit the escape of the metal cuttings and fluids.**

**Fishing Tools** - Special tools used to retrieve fish from the hole.

**Fluid Drilling** - The medium, liquid or gas for flushing cuttings from the hole being drilled, for cooling the bit and for lubricating the bit.

**Foam Flushing** - A liquid chemical added to the flushing water to stabilize the hole walls and to remove the drill cuttings effectively.

**Gel Strength** - A measure of the effect of the forces between the particles while the mud is at rest.

**Hoisting Line** - Wire rope used on the draw-works to hoist and lower the drill string.

**Hydraulic Percussion Drilling** - This is also known as hollow rod-drilling method. It employes a chisel shaped bit. A ball check valve is provided between the bit and lower end of the drill pipe string. Drilling is done by lifting and dropping the drill rods and the bit with quick short strokes. The drilling liquid is supplied at the surface in the annular space. It enters the ball check valve during downward stroke of drill pipe. When the bit is picked up, the ball check valve closes and traps the fluid inside the .drill pipe. Continuous reciprocating motion produces a pumping action to lift the fluid to the top of the string of drill pipe where it discharges in to a settling tank.



**Impression Block** - This block has many forms and designs and often used to obtain an impression. of the top of the fish before attempting fishing operations.

**Jet Percussion Drilling** - In this method, a chisel shaped bit is attached to the lower end of string of pipe. Holes on each side of the blades of the bit serve as nozzles that help in loosening the material being drilled and keep the bit clean. The drill rods are rotated by hand to make the drill cut a round hole. The drilling fluid flows from the mud pit through the pump, stand pipe, hose, drill pipe and comes out through nozzles in the bit. It then flows through the annular space to the settling pit and back to mud pit. With fluid circulation maintained, the drill rods are lifted and dropped in a manner similar to cable tool drilling but with shorter strokes. The bore hole is thus drilled by chopping action of the bit combined with washing action of water jets.

**Kelly** - A formed or machined section of hollow drill steel which is joined directly to the swivel at the top and to the drill pipe below. The flats or flutes of the kelly engaged the rotary table so that the rotation of the rotary table is transmitted to the kelly, which, in turn, transmits it to the drill pipe and consequently to the rotary bit.

**Loss of Circulation** - The loss of drilling fluid into formation pores or crevices.

**Mast( Derrick or/Tower)** - A structure on the rig used to support the crown block, top drive, pulldown chains, hoisting lines, etc. . It is also called Derrick or Tower.

**Pipe Handling Equipment-** The equipment for storing, adding and removing lengths of drill pipe.

**Piezometric Surface** - It is the elevation to which no water level rises in a well that taps artesian aquifer.

**Power Take Off - The means of transmitting power from the engine of the power package, or a truck or a tractor, to the other components of a drilling rig. This is usually accomplished by a separate shifting arrangement in the transmission pull down.**

**Pulldown (a) Thrust or weight applied to the bit through the drill String**

**(b) The mechanism which provides either the hoisting or pulling power.**

**Reamer** - Cutting tool used to enlarge a bore hole.

**Reverse Circulation Rotary Drilling** - In this drilling process, a string of drill pipes with a drill bit at the bottom is rotated by mechanical means. Plain water or a fluid of gelling quality, depending on the strata conditions is circulated to prevent the hole from caving in and for sucking up the drill cuttings through drill pipes. The flow of drilling fluid

takes place from the mud pit to the annular space then through the opening in the bit to drill pipe~ the centrifugal pump or the jet educator settling pit and back to mud pit.

**Rig** - A drilling machine used for drilling a bore hole.

**Rotary Drive** - Use of power shaft to transmit driving power to the rotating element.

**Rotary Hose** - The air or mud hose that leads from the stand pipe to the swivel. Known also the fluid (Air) or Swivel-Hose.

**Rotary Table** - Power Swivel and / or the Rotation Drive transmitting rotation to the drill string and bit.

**Safety Hook** - A hoisting hook with a spring loaded latch that prevents the load from accidental slipping off the hook.

**Sand Content** - The percentage bulk volume of sand in a drilling fluid.

**Slips** - Wedge or wedges used to prevent the drill pipe or casing pipe from tipping through the opening in the rotary table when the bit is off the bottom during trip or when adding or taking off a section of drill pipe. These may be hand or power acted.

**Stand pipe** - A vertical pipe or hose carrying either air or mud to approximately the middle of the mast where it is connected to the mud rotary or swivel hose.

**Strata** - Alluvium / Rocky

**Rocky** - Rocky area shall mean, area where the strata essentially comprises of the rock formation. Rocks may be with or without fissures and faults, joints and bedding planes, may have fractured and weathered zones. Rocks may be soft, medium or hard and comprise of shales, sand stones, lime stones, dolomites, quartzites, basalts, granites, schists, fillites, slates, gneisses and their intercalation intrusives and conglomerates of these, but shall exclude clays, sands, pebbles, cobbles and boulders morum and silt stones.

**Alluvium** - All alluvium areas shall mean areas where the strata comprises of loose, unconsolidated materials like clays, silts, sands, gravels, pebbles, cobbles and boulders.

**Sub** - A substitute, or adaptor, which is used to connect from one type or size of threaded connection to another.

**Swivel** - The mechanism which permits the passage of mud or air from a stationary hose into a rotating member, such as the kelly or drill pipe.

**Thinner** - A substance that reduces the apparent viscosity and gel development of mud without lowering the density. The addition of thinner affects the colloidal clay fraction of mud

**Tongs** - The tools used in making or breaking a joint of pipe during a drilling operation. Their action is much the same as that of a pipe wrench.

**Toll Joint** - Threaded portions of the drill string which may be either box or pin type.

**Transfer Case** - A transmission to distribute power from the engine to other rig components.

**Verticality of Tube Well** - It means verticality of casing pipe or housing pipe upto 200 mm dia and upto 30 metre depth in one direction and in one plane and upto 50 metre depth for casing pipes of more than 200 mm dia.

### **41.3 MATERIALS, EQUIPMENTS AND THE ACCESSORIES**

#### **41.3.1 Bail Plug or Bottom Plug**

It is a closed socket provided at the bottom most end of the pipe assembly. It is made of mild steel or cast iron or wrought iron. A simple mild steel plate welded at the bottom end of pipe is sometimes used. (See Plate 41-P/1).

#### **41.3.1 Bail Plug Hook**

It is inverted "f" hook made of mild steel, attached to the bottom plug or a bar of mild steel fitted across the blind pipe (See Plate 41-P/1). HDPF blank and perforated pipes can be considered for low cast tubewells in future.

#### **41.3.3 Blank Casing Pipe.**

It is placed against strata from which water is not to be tapped. It is provided against non-aquifer portion. It is made of mild steel, wrought iron, fibre glass, stainless steel or non-corrosive material It shall conform to IS: 1239 (Pt.1)-1985 for diameter upto 150 mm and IS:4270-1983 for diameter above 150 mm(See Plate 41-P/2).

#### **41.3.4 Screen and Slotted Pipe**

**41.3.4.1 Types and Material** -The Specification of Material of slotted pipe shall be confirming to above (The slot pattern of the slotted pipe shall be according field requirement and shall be decided by SE as laid down in 41.3.4.2.3.

#### 41.3.4.2 *Design Features*

**41.3.4.2.1** *Length of Slotted Pipe* - The length of slotted pipe shall be governed by the thickness of aquifer and shall be sufficient to obtain the designed specified yield from tubewell. However, the minimum total length shall be such that the entrance velocity is less than the permissible entrance velocity of 0.03 m/s to ensure longer life of the well. The lengths of individual pipes shall be such as to afford easy handling for transport and lowering into wells, and removal in the case of recovery, etc~ The lengths shall be such that there is minimum wastage in using combinations of various lengths inside the wells, and to ensure that the combinations from the nearest requirement to obtain the estimated specific yield of, the well. They may be in random lengths specified by the Engineer-in-Charge.

**41.3.4.2.2** *Diameter of the slotted pipe:* -The criteria for determining the diameter of the slotted pipe shall depend on the designed yield of the tubewell. It shall be ensured that the area of opening available in the slot for flow of water, after giving allowance for possible coverage of gravel, clogging, incrustation etc. shall produce a slot ~trance velocity of not more than 0.03 metre/second. The diameter of slotted pipe shall be so selected that the percentage of slot area to screen surface area is generally between 15 to 22 percent or as decided by the department.

Screen diameters for various discharge to be pumped from the well, are given below for general guidance.

The diameter of slotted pipe shall be 150 mm/200 mm according to discharge of the zone, however' large dia of the slotted pipe, if necessary can also be considered with .the advise of the field S.E.

Discharge in litres / Minute	Screen Dia in mm	
	Minimum	Recommended
up to 475	100	150
475 - 1125	150	200
1300 - 3000	200	250
3000 - 5200	250	300
5200 - 9500	300	350
9500 - 13300	350	400
13300 - 19000	400	450
19000 - 26500	450	500
26500 - 34000	500	550

**41.3.4.2.3** *Slot Size* - The shape and size of the slot shall be such that the gravel or aquifer material is not allowed to block the open space. Based on the sieve analysis of the aquifer material the size of the slot opening shall be determined in such a way that finer fractions of the formations are removed during the development stage of the well- and the coarser fractions remain outside the slots. The slots shall not be too wide to cause entry of the gravel and result in plugging. Sharp edges on the periphery of the pipe may offer resistance to flow and hence it is preferable to have smooth rounded edges.

The slot size for gravel pack shall be so selected as to retain atleast 90 percent of the pack material. However, in case where well is not provided with gravel pack, slot size (s) shall be such that it would allow 40 to 60 percent of the aquifer material to pass through. The normal slot sizes shall be 1.0, 1.6 and 3.2 mm. For fibre reinforced plastics (F R P) pipes, the slot width shall not be less than 1.6mm. The guidelines for selection of slot size is given in Appendix I.

**41.3.4.2.4** *Percentage Opening* -The percentage slot opening shall be such that the screen length provides sufficient inlet area to limit the entrance velocity as specified in 41.3.4.2.2.

**41.3.4.2.5** *Distribution of slots* - The slots be cut in a pattern designed to get even distribution of flow all over the periphery of the pipe. The slots shall be distributed in rows as closely and evenly as possible, staggering the slots between each row. The slot size, design and distribution should be such as to maintain sufficient collapse strength of the screen .

### **41.3.4.3** *Specific Design Feature*

#### **41.3.4.3.1** *Plain slotted Pipes*

**(a) Low carbon or mild steel slotted pipes-** The slots shall be cut by milling or by slitting saw. The recommended thickness of different diameters of slotted pipe for tubewell under normal conditions is given in 41.3.3 and later amendments from time to time by ISI.

.Typical slot pattern of well screen is shown at figures 1 and on 2 Plate 41 - P/3

The slots shall not be cut within 12 mm on either side of the longitudinal welded joints of the pipes. The plain space after thread cutting over the larger diameter pipes shall not be less than 150 mm so that wrenches could easily be used on plain space only.

#### **41.3.5 Centralizer or Centralizing Guides**

These are fitted *to* the well assembly except the housing pipe at suitable spacing to keep the assembly in the centre of the hole, so that an even thickness of gravel pack around it is ensured. It is made of mild steel and of the design specified by the Engineer -in -Charge a typical guide is shown at Plate 41 - P/6.

#### **41.3.6 Taper Reducer**

A taper reducer, made of mild steel, is intended *to* connect the housing pipe with assembly pipe. It also helps in reducing bridging in the gravel pack (See plates 41P/1 & 41-P/3).

#### **41.3.7 Housing Pipe**

It shall conform *to* IS:1239 (Pt.I)-1985 for diameter upto 150 mm and *to* IS:4270-1983 for diameter above 150mm. The pipes shall be of heavy duty and be provided at least 0.6mm above the ground level. The inside dia. of the pipe shall be 25mm and 50 mm more than the bowl dia of the pump with capacity upto 1300 litres / minute and upto 2200 litres/minute respectively. It is necessary for housing the pump or its suction pipe. Its length depends 'On the lowest static water level taking in *to* account the seasonal fluctuation factors (See plates 41-P/2, 41-P/8, 41-P/9) as draw down and other factors. .

It furnishes a direct connection between the surface and the aquifer; when permanent surface is not used it seals out undesirable surface or shallow groundwater and the side of the hole. In areas of thick unstable materials, housing pipe casing may have *to* be supported at the ground surface which can be done by welding I beams *to* the casing as shown on Plate 41-P/7.

#### **41.3.8 Clamp**

It is fixed at the top of the tubewell for supporting the well assembly. It is made of mild steel.

#### **41.3.9 Well Cap**

Made of mild steel, it is used *to* keep the tubewell closed after its completion until the pump set is installed. It is either threaded *to* be screwed to top of the housing or simply a plate is spot welded so as to be easily removed when required (See Plate 41-P/9).

#### 41.3.10 Pump Set And Accessories

Either vertical turbine or submersible pump comprising of the following shall be used. The selection of pump shall depend upon the pumping head and discharge.

- (i) Pump
- (ii) Motor
- (iii) Column pipe/ Delivery pipe with bend
- (iv) Air line
- (v) Sluice and Reflux valve where necessary
- (vi) Water level guard with signal cable and electrode (vii) Pressure gauge.
- (viii) Water level indicator
- (ix) Irrigation panel as per M.P.E.B. Rules

#### 41.3.11 Column pipe

It is G.I pipe directly connected with pump motor assembly. It acts as delivery pipe, provided with a 90° bend and a sluice valve for controlling discharges. Minimum length of column pipe is governed by SWL +fluctuations+draw down+0.6 m and it shall have 0.9 m horizontal length. Dia. of the column pipe shall be decided by the size and capacity of the pump.

#### 41.3.12 Valves

Gun metal sluice valve of delivery pipe size shall be used where necessary.

#### 41.3.13 Irrigation Panels

These duly connected with suitable capacitor as per M.P.E.B. recommendations with the following specifications shall be used.

- (i) Upto 5 HP. - Direct on line (D.O.L)
- (ii) Upto 15 HP. - Star Delta starter
- (iii) Above 15 HP. - Auto-transformer starter

#### 41.3.14 Pressure Gauge

It shall be of 100 mm size.

#### 41.3.15 Bentonite

It shall have swelling factor of 1200%

**41.3.16 Gravel**

It shall conform to IS:4097-1993 or as found in the rivers of M.P. but shall be 3 mm to 8 mm of suitable geological formation with lime kanker in permissible limits as laid in department's circular.

**41.4 SITE SELECTION AND EXPLORATION****41.4.1 Investigations**

**41.4.1.1 *Planning and Reconnaissance*** - Planning a ground water investigation or project requires a thorough appreciation of the purpose, the scope of the work required, geological complexity of the area involved and the limitations imposed by available financing and allotted time. Sufficient data are frequently available from previous investigations to solve a problem or develop a plan without additional field work. Geological survey reports on geology and hydrology if available for the connected area, often provide valuable information. After completion of the review, abstraction and summarization of available information a field reconnaissance of the area shall be made to determine field conditions, obstacles, limits and possible alternative methods for completing any additional work contemplated.

**41.4.1.2 *Sub-Surface Investigations*** - Of primary interest in most ground water investigations is the information on the stratigraphy, structure and hydraulic characteristics of the subsurface materials and on water table and piezometric surface levels and fluctuations. The information can be obtained from logs of wells previously drilled in the area, samples of material from wells, well pumps test, and records of levels of the water table or piezometric surface.

**41.4.1.3 *Geophysical Surveys*** - Geophysical surveys made in conjunction with reconnaissance, surface geologic investigations and exploratory drilling if necessary may permit a rapid and relatively low cost evaluation of the subsurface geology and possibly the general ground water conditions of an area. Four basic methods of geophysical surveying are available; seismic, electric resistivity, gravimetric and magnetic. Many variations of these four basic methods have been developed and prior to considering a survey, a qualified geophysicist shall be consulted about the type of survey best adopted to obtaining the data desired. The seismic methods using explosives as an energy source are particularly adopted to use in large areas where deep probing is required. Electric resistivity surveys are applicable to large or small areas and are extensively used in ground water investigation because they are responsive to moisture conditions, equipment is readily portable and the method is commonly more acceptable than the seismic methods. The resistivity method is however not usable in the vicinity of power plants, sub stations, high tension power lines and similar sources of extraneous earth currents. The magnetic survey is only suitable for determining a limited amount of sub surface geologic



Information and is therefore best suited for magnetic mineral exploration. The results of gravimetric surveys are less detailed than with seismic or resistivity methods. The resistivity test is thus extensively carried out for ground water investigations.

**41.4.1.4**      *The survey shall thus involve the following activities*

- (i) Preliminary reconnaissance survey
- (ii) Inventory of existing wells and tubewells.
- (iii) Preparing water table maps and studying its fluctuation based on observation of existing dug wells and tubewells.
- (iv) Collection and testing of water and aquifer samples.
- (v) Pumping tests of dugwells and tubewells.
- (vi) Geological mapping of the area.
- (vii) Exploratory drilling in the area if necessary.
- (viii) Geophysical surveys and correlation studies.
- (ix) Evaluation correlation of the data and marking of potential zones for dug wells and tubewells.
- (x) Assessing ground water potential of the area and preparation of ground water exploration report.

**41.4.1.5.1**      *Density and Spacing of Tubewells.*

**41.4.1.5.1**      While taking up construction of tube wells, it is essential to see that yield of existing wells or tube wells shall not be affected adversely. For this purpose, based on the recharge of ground water in the area and hydrological parameters of the aquifer, minimum spacing and maximum density criteria shall be observed. Provisionally it is recommended that shallow tube wells shall not tap the first unconfined aquifer and shall tap the second and third aquifers. The minimum spacing between two shallow tubewells or between a shallow tubewell and dug cum bore well of 45 m depth shall be 450 metres in alluvial aquifers and 300 metres in rocky aquifers respectively. or as modified by Government from time to time.

**41.4.1.5.2**      *Suggested Spacings -* It is provisionally recommended that a tube well shall be located at a distance as fixed by Government in Water Resource Department from time to time and 300 metres away from the existing unlined deep cutting canals. The state tubewell to be drilled shall be out of command of existing canals as well as the canals that

would come up in near future except in case of tube wells meant for antiwater logging purposes,. The minimum spacing between a shallow tube well and a deep tube well shall depend upon the following factors:

(a) Tapping of Aquifer by the Two Tube Wells - For example, if the shallow tubewell is tapping first two (second & third) confined aquifers and the deep tubewell tapping the fourth and subsequent confined aquifer then in this case there shall be no interference between the two tubewells and they can be spaced quite close to each other also. Distance between Dam wall and shallow tubewell shall be decided with the permission of concerned W.R.D. Authorities.

(b) The spacing shall depend upon the draw down created in aquifer vis-a-vis its effect on the cone of depression of tubewell in question.

(c) The spacing shall also depend upon the aquifer characteristics ie. storage, co-efficient, transmissibility, permissibility etc.

(d) The interference, also depends upon the number of hours pumped. If a well is pumped night and day, without any break, the interference distance goes on increasing, unless the aquifer is so vast and so under utilised that even heavy pumping does not cause any interference of the cone meets the recharge boundary.

**41.4.1.5.3** Norms for successful Tubewell "In M.P. a Tubewell" is said to be successful for irrigation purposes if it yields a discharge exceeding 2500 gallons/hour in hard rock areas and exceeding 5000 gallons/hour in alluvial areas.

#### **41.4.2 Selection of Site**

The site where the Engineer-in-Charge wants to sink the tubewell shall be examined by an expert keeping in view the requirements of para 41.4.1. Any previous data available regarding near by tubewells shall be made use of.

#### **41.4.3 Test Drilling**

In order to avoid infructuous expenditure it is desirable to drill test hole in the unexplored area first to collect preliminary data regarding static water level, nature of strata, quality of water, draw down and probable yield, aquifer parameters etc.

**41.4.3.1** If the test hole is located at a distance (see E-in-C-19, Page 81 under exploratory drilling) away from the site of the proposed tubewell (test hole) having similar strata conditions, it may be made use of during the construction of the tubewell to collect correct information on the underground water conditions etc. Where such test drilling is done, the following procedure shall be adopted.

(a) The test hole finished shall be at least 100 mm in diameter and in rocky area core drilling be preferred over D T H.

(b) A complete and accurate log of the bore hole when it is being drilled shall be kept. Samples of formation shall be collected at a maximum of 2 m intervals, or whenever there is any change in strata.

(c) The total depth drilled shall be sufficient to determine the depth and other characteristics of the 10\vest aquifers as anticipated from other local considerations etc.;

#### **41.5 TYPES OF TUBEWELLS AND THE CONSTRUCTION**

##### **41.5.1 Type 1 (Cavity Well)**

Cavity wells are generally shallow tubewells drilled in alluvium formations (see Plate 41-P/2). It is a well with casing resting in a thick hard impervious layer above the aquifer. It is a pre-requisite that the impervious layer which is generally of clay should not disintegrate when water is pumped out and with the passage of time. Such wells can be taken under exploration.

The cavity is developed by pumping out fine sand with bailor pumping unit or an air compressor. The area available for water flow into the well being limited, the yield for this type of well is comparatively less. Usually no pipe is lowered in side cavity. In a cavity well any type of pump could be fitted depending upon static level and the size of the pipe and the available discharge.

##### **41.5.2 Type 2 (Strainer well)**

This is a well constructed in alluvial formations (See Plate 41-P/1). The strainer used may be agriculture type, or of brass, or coir rope type which is placed against the granular zones. During development of such wells by plunger or over pumping unit the

fine sand is pumped out from the strainer allowing coarser material to rearrange itself around the strainer. This type of well is also called as natural gravel packed well. Such tubewells are generally constructed to a depth of about 150 m. But they are now not in use of practice.

##### **41.5.3 Type 3 (Slotted well)**

Wells with slotted pipes with openings between, 15 to 22 percent of surface area, to suit the aquifers are constructed where the aquifer consists of comparatively finer sands. The diameter of the bore is larger than the assembly pipe, to allow a gravel pack of desired thickness all around the pipe (see Plate 41-P/8).

**41.5.3.1** In the overburden at times, it is necessary to grout the housing pipe with

cement to ensure safe sanitary conditions, specially when the tubewell has been constructed for drinking purposes ( See plate 41-P/9) . Cement seal is also necessary in the saline zone.

**41.5.4 Type 4 (Artesian Well or Flowing Tubewell)**

Construction of this category of well is limited to places where artesian water formations are available. For constructing artesian well, the intial drilling shall be carried to at least 500 mm or as the case may be below the top of the first impervious layer and the housing pipes lowered to the required depth. The annular space between the housing pipe and the bore is cement grouted and allowed to set to ensure a perfect seal, so that the djscharge does not come out from outside the housing. Further drilling is carried out and the assembly is lowered and a sluice valve is fitted at the discharge pipe end. Gravel is poured into the annular space and the top of the housing pipe is closed with a M.S.plate welded to seal the annular space between the assembly and the housing pipe. The water with artesian pressure will flow out from the discharge pipe which is controlled by operating the sluice valve. (See plate 41-P/12A). These types of tube we list may also be constructed to suit the installatiqn of a horizontal centrifugal pumping set installed close to static water level in a masonry sump instead of a bore hole pump set. In that case, no pump housing pipe shall be necessary. For rocky artesian well See plate 41-P/12-B

..

**41.5.5 Type 5 (Tubewells in Hard Rock Formations with Fissures)**

The overburden in such a well is encased to eliminate the risk of caving in. Drilling is further carried out and the bore is left open to allow the water to flow from the crevices and fissures in to the bore ( See Plate 41-P/13).Suitable pump can be lowered depending upon the discharge and pumping water level.

**41.6 DRILING METHODS**

**41.6.1 Auger Drilling**

The drilling is done with a spiral or worm auger connected to square rods turned manually with rod tillers. The cuttings produced as a result of drilling are removed with a sand shael. Steel casing pipes with drive shoes at the bottom are lowered as the drilling progresses. This method is employed where very shallow drilling in alluvium formation is involved ( SeePlate 41-P/10) .

**41.6.2 Water Jet Boring.**

A drill bit with nozzles is attached to the drill pipes at its bottom and through which water is pumped at high pressure. The water on its return flow through the annular space between the bore and the drill pipe, brings out the cutting along with it to

the surface. Casing pipe is simultaneously used to avoid caving-in. The method is suitable for drilling shallow wells in loose sandy formations (See Plate 41-P/II)

#### **41.6.3 Calyx Drilling**

A bit made from hollow steel tube with two inclined slots called 'shot bit' is connected below another tube (core barrel) which is further connected to the drill rods. These are rotated mechanically. Chilled shots are fed to the bottom of the bit through the drill string along with water. These are ground by the shot bit to form abrasive material with sharp edges which cuts into the consolidated formation forming an annular ring to form a core inside the core barrel, which is then taken out from well by grouting the core with quartz chips etc. This method is successful for shallow tubewells drilling in consolidated formations with large diameter holes.

#### **41.6.4 Percussion Drilling**

A heavy bit attached with a drill stem, a drilling jar, and to a cable is given up and down spudding motion, either manually or by power. Water is added to dissolve the cuttings which are lifted out by means of a bailer. Steel casing pipes with drive shoes are used as the hole progresses. This method of drilling is only suitable for drilling in boulder formations. Large diameter holes can be drilled in alluvium formations as well as where for drilling is not easily available.

#### **41.6.5 Rotary Drilling.**

**41.6.5.1 Direct Circulation -** A drill bit is rotated mechanically by means of drill pipes, through which drilling mud ( usually bentonite mixed with other suitable material) is circulated under pressure. This process of circulation lubricates the bit, carries the cutting in suspension to the surface and also plasters the wall of the hole to prevent it from caving -in. Very deep well can be constructed in alluvium formations.

**41.6.5.2 Reverse Circulation Method -** A String of drill pipes with a drill bit at the bottom is rotated by mechanical means. Plain water or a fluid of gelling quality depending on the strata conditions, is allowed to flow in to the bore hole, when drill cuttings along with water are sucked through the drill pipes by centrifugal pump and thrown into the settling pit. The hole remains intact under the hydrostatic pressure of the drilling fluid, the level of which is maintained continuously. Very large diameter holes up to 1500 mm to a depth of 200 to 250 m can be drilled in alluvium formations.

#### **41.6.6. Down the Hole Hammer Drilling**

The method is used for fast and economical drilling of small bore (200 mm Max) in medium hard to hard formations in quarry, construction of water wells and

geophysical work. The method is very fast penetrating and is very suitable for drilling in hard formations where there is scarcity of water. Compressed air is fully utilised for the rapid impacting action given by the hammer and thus crushing the formation into small chips which are flushed out through the annular space between the bore and the drill pipes. The machine should be fitted with a compressor which should be capable of producing return velocity of 915 to 1220 m/min.

**41.7 WELL LOGGING (Geological data)**

**41.7.1** Sample of drill cutting from different strata shall be collected at suitable intervals, preferably at every 2 m depth drilled or at closer intervals, if a change in the strata is met with.

**41.7.2** After the drilling, has reached sufficient depth all the samples of strata collected shall be carefully examined and analysed.

**41.7.3** The samples shall be dried and stored properly, which shall be preserved carefully by the Engineer -in-Charge of the tubewell.

**41.7.4 Drilling Time Log** -It is recommended that as the drilling progresses an accurate drilling time log be kept indicating the time taken to drill every two metres depth or where there is change of strata this log will enable interpretation regarding the nature of the formations (hard, soft, unconsolidated etc.) which has a bearing on the water yielding capacity of the formation. Drilling log in the form given below shall be prepared in the following manner:

S.No.	Lithology	Depth Range (M)		Thickness (m)
		From	To	
(i)	Clay, top soil, brown, slightly hard and plastic	.....	.....	.....
(ii)	Clayee sand and gravel	.....	.....	.....
(iii)	Gravel mixed with clay and kankar	.....	.....	.....
(iv)	Clay, brown, yellowish, brown chocolate or grey, hard, plastic with a little angular to sub-angular gravel	.....	.....	.....
(v)	Water bearing sand	.....	.....	.....

## **41.8 DESIGN AND LOWERING OF PIPE ASSEMBLY**

### **41.8.1 Design of Pipe Sizes and Lengths**

The length and diameter of the housing pipe is selected on the basis of static water level, the draw do the discharge expected from the well and the size of pump to be installed. The size and length of blind pipes and slotted/strainer pipes are selected according to the actual requirement, according to the strata met with, the expected discharge and the depth of tube well.

### **41.8.2 Design of Screen Slots**

The size and distribution of the slots shall be as specified in para 41.3.4.2

## **41.9 GRAVEL PACKING**

**41.9.1** All gravel shall consist of hard well rounded particles reasonably uniform in diameter and shall be of a size, determined after analyzing the character of the water bearing formation tapped. The thickness of the gravel around the screen shall generally not be less than 7.5cm

**41.9.2** In percussion method of drilling, gravel is fed into the annular space between the casing pipe and the 2ssembly pipe upto 3 m above the bottom of the slotted pipe, The well is developed using compressed ail' or by bailers and as the water becomes clear, surging or backwashing is done to make the development more perfect. More gravel is fed, if necessary, and when the water become free from sand, the casing pipe is jacked up to some height, and the process is repeated until all the aquifers are gravel packed. Care shall be taken to ensure that the pack of gravel above the bottom of the casing pipe is never mere than] ill in leng1:h as otherwise the casing pipe is likely to be locked up with the well assembly due to friction of gravel pack in between.

**41.9.3** In rotary method, the pipe assembly is lowered into position and gravel packing may be done up to li suitable depth below the bottom of the housing pipe in the first mstance, Thereafter, the gravel packing up to the required depth is completed after keeping the housing pipe vertical within limits. To achieve uniform gravel packing around the pipe assembly inverted cones shall preferably be used.

## **41.10 DEVELOPMENT OF TUBEWELL**

Generally all type of well shall be developed either by surging and agitating or b) over pumping and backwashing with an an-lift and high velocity jetting, etc. Any other acceptable method may also be adopted. However in alluvial area this development

process shall be continued until the stabilization of sand and gravel pack has taken place and sand pumping in limits specified in 41.10.1 below.

**41.10.1** The development of the tubewell by over pumping shall be done at 15 percent to 25 percent higher discharge than the expected discharge from tube well. The final discharge shall be free from sand with a maximum tolerance of 20 parts of sand in one million parts of water by volume after 20 minutes of starting the pump.

#### **41.11 MEASUREMENT OF TUBEWELL DEPTH**

##### **41.11.1 Measurement by Means of Cables or Rods**

This method is suitable for measurement of depth of tubewells in a rocky formation. The bottom of tube well shall first be cleaned and the depth measured by; (a) twisted metallic cable strained by a pump -bob, and (b) means of rigid rods. With any of the above methods three distinct measurements shall be taken and effective one will be the average reading of the three. If the depth of tubewell does not exceed 100 m, the accuracy of measurement shall be decided by the Engineer-in-Charge.

##### **41.11.2 Measurement by Means of Casing.**

This method applies to alluvial unconsolidated formations and is used for any tube wells with well assembly. (i.e. bail plug to ground level). The depth of tube well shall generally be equal to length of the assembly lowered. Each pipe shall be measured to and accuracy of  $\pm 0.1$  percent. The accuracy of measurements is  $\pm 0.3$  percent.

#### **41.12 MEASUREMENT OF WATER LEVEL**

##### **41.12.1 Direct Measurement**

This is carried out by a steel tape or cable with a suitable sinker attached at the end. The steel tape or cable is wound round a rotating drum. Measurement shall be done by measuring the length of tape or cable. Depth of immersion of sinker shall be taken into account in the measurement. A set of three readings shall be taken and effective will be their average. Any measurement which deviates from the average by more than  $\pm 0.3$  percent shall be discarded and new measurement to be taken in place. Accuracy of measurement shall be decided by the Engineer -in -Chief.

##### **41.12.2 Electric Measurement (Double Pole Contact)**

Double Pole Contact (See plate 41-P/14), a sufficiently rated battery, a reel with a length of twin electric cable and an electrical indicating instrument as a high resistance voltmeter or a millimeter are required. The items shall be adjusted as shown in the, plate. One end of the enable shall be permanently connected to voltmeter/ammeter



and the other end to be connected through battery. As the cable is lowered into the tubewell the circuit is completed, as soon as the two electrodes strike the water and the instrument indicates. The depth of water level is obtained by measuring the twin cable from the electrodes to the top of tubewell.

**Wherever electric power is more easily available, battery may be replaced with the power supply mains. In this case, single pole method may be used. For single-pole contact, the apparatus is similar to as described for two-pole contact with the difference that the contact casing is fitted with one electrode and a single cable. The circuit is completed through the rising main as soon as the electrode touches the water. Measurement is similar to two-pole contact method. This method shall be employed only when the casing extends from the top of the bore hole to below the water surface to be measured.**

### 41.12.3 Air Pressure Lime Method

This consists of:

- (a) a tube positioned between casing and the outlet pipe and extending to below the depth of water,
- (b) a saturated pressure gauge graduated in metres of water or in MN/m<sup>2</sup>, and
- (c) an air pump and non-return air valve.

All above items shall be adjusted as shown in Plate 41-P/15. For example, if water level 'L' is to be determined, air is pumped into the air tube, until maximum reading is obtained on the pressure gauge. The complete air tube will be filled with air and the pressure reading corresponds to 'A'. At the time of setting, distance 'B' should be noted. The required 'c' will be the difference of 'B' and 'A' readings.

### 41.13 VERTICALITY AND ALIGNMENT

**41.13.1** If a turbine well pump is to be installed in a well, the well shall be true to line from its top to a point just below the maximum depth at which it is proposed to set a pump. A tubewell out of alignment and containing kinks and bends or cork-scrwes shall be rejected because such deviations cause severe wear on the pump shaft, bearings and discharge casing and in a severe case, might make it impossible to get a pump in or out. If an air-lift or a suction pump is used for pumping, alignment is not so important and the same is applicable to the submersible type of pump. .

**41.13.2** In case of gravel-shrouded tubewells if the pipe assembly is found inclined in a slant position before completing the gravel pack, the assembly shall be pulled in a desired direction by suitable methods with a view to rectify slantness and bringing -the pipe assembly within the permissible limits of verticality. The gravel pack shall be completed immediately after the verticality has been tested and rectified.

**41.13.3** The verticality of the tubewell shall be tested by using plumb or plunger E (see Plate 41-P/16) 6mm smaller in diameter within the inside diameter of the well casing. The plumb may be made from a piece of sheet steel or a short piece of pipe. Whichever is used, it shall be heavy enough to keep the plumb line tight. The hub of the ring shall not be solid as the water shall pass through it as it is lowered in the well. The hole F from which the plumb line A passes shall be in the exact centre of the ring. Knots or marks shall be made every 3 metre on the plumb line to indicate the depth to which the ring has been lowered in the well. The plumbing shall be suspended from the guide pulley where it shall be at least 3 m above the top of the well. The guide pulley is fixed on a tripod or frame B as shown in the figure. The vertical centre of the pulley shall be so located that the plumb line A comes off its outer edge exactly over the centre D of the well casing. The method of recording the results shall be as shown in Appendix - m.

**41.13.4** For tubewells encased with pipes upto 350 mm diameter the verticality of the tubewell shall be measured in terms of clear cylindrical space available within the housing pipe after the construction of the tubewell.

**41.13.4.1** Verticality of the tubewell shall have a deviation so as to provide clear cylindrical space not less than the clear cylindrical space available in a hypothetical tubewell of the same size but having deviation of 10 cm per 30 m in one direction and in one plane only.

**41.13.4.2** The verticality of the tubewell is to be tested as given in 41.13.3. After the necessary computation is made, cross sections of housing pipes at different depths are drawn on a graph and clear cylindrical space is determined. This cylindrical space of the actually constructed tubewell shall be referred as 'G' in the following paragraphs.

**41.13.4.3** Cross sections of hypothetical tubewell indential in dimensions to the actual tubewell but having deviation of 10 cm per 30 m in one direction and in one plane are drawn on the graph sheet and the minimum allowable cylindrical space 'H' is determined.

**41.13.4.4** If cylindrical space 'G' of the actually constructed tubewell is equal or more than the cylindrical space 'H' of the hypothetical tubewell, (having deviation 10 cm in 30 m in one direction or one plane) the tubewell actually constructed shall be considered within the permissible limits of verticality.

**41.13.4.5** As an example cross sections of two tubewellis G1 and G2 having 300 mm diameter of housing pipe have been drawn after computation of verticality results in figure

1 & 2 of Plate 41-P/17, while figure 3 of same plate shows the cylindrical space 'H' of / hypothetical tubewell having deviation of 10 cm per 30 m depth of the tubewell. It will be noticed that space G1 is more than space 'H', while space G2 is less than the space 'H'. Therefore, tubewell G 1 shall be considered within the limits of verticality while G2 is not within the limits of verticality.

#### **41.14 TESTING FOR YIELD AND DRAWDOWN**

**41.14.1** After the well has been completely constructed and cleaned out and the depth of the well accurately measured, this test shall be conducted by installing a test pump in the tubewell temporarily and pumping out water. At each rate of discharge, pumping is carried out at least for 30 minutes. The specific capacities of the well for various pumping rates is computed based on drawdown test data. Discharge may be measured by any method detailed in 13.7 of IS:5120-1991 or as specified in the technical circulars of the tubewell department.

**41.14.2** Since the yield is influenced by a number of factors such as geological formation, rainfall, neighbouring tubewells, etc, the pumping rate shall, in general not exceed 60 percent of the yield determined by test. It is recommended however, that geological advice should be obtained on the percentage to be adopted for each location. Minimum yield have been specified at respectively for alluvium and rocky areas. The tubewells which do not give the minimum yield shall have to be declared by the Engineer-in-Charge as unsuccessful wells. In such cases, the well assembly should be pulled out immediately. All assembly pulled out shall be immediately measured by the Engineer-in-Charge or his representative in the presence of the representative of the drilling agency, if necessary and the assembly so pulled out after the approval of Engineer-in-Charge may further be used. Statement of recovery and loss be maintained and should be submitted by the site in charge.

**41.14.3** A well shall be declared by the Engineer - in - Charge as an abandoned well in case of non-verticality caving in or any other defects attributable to the poor workmanship and also in case of unsuitability of equipment. In such cases, the well assembly if lowered, (at whatever stage it may be) shall have to be pulled out immediately as specified in 41.14.2

**41.14.4** Back Filling of Abandoned or Unsuccessful Wells Back filling with natural material- of the formations encountered shall be suitably carried out by the drill rig agency for all abandoned and unsuccessful wells after extracting the well assembly in the manner described at para 41.14.2 and 41.14.3 above. This back filling shall also be duly rammed at ground level with allowance for settlement. This whole operation shall be carried out by the drilling agency at his own cost without any claim on this account and in a manner so as not to cause injury or accidents to any people or cattle etc.

**41.14.5 Fishing Operation**

If during any of the operations carried out by the drilling agency any tools, pipes, accessories etc. fall down in the well being constructed, it shall be the wholesome responsibility of the drilling agency to carry out the necessary fishing operations with his equipments in a manner so as not to damage the fallen parts in any way and without any claim of any .such fishing operations.

**41.15 QUALITY OF WATER**

**41.15.1** In the construction of the well, due precautions shall be tak~ by the drilling agency to maintain the premises in a sanitary condition and to avoid as much as practical, the entrance of contaminated water into the safe water bearing formations. Any water or materials used shall be free of contamination and, if their nature permits, shall be adequately disinfected with chlorine before use. The slush pit shall be constructed so that no material therefrom will entre the well, except mud reused when the construction is by rotary method. In such cases the slush pit and mud return channels shall be protected against contamination from surface water or any other sources.

**41.15.2** Water shall be collected during aquifer performance test and analysed chemically as desired by the Engineer-in-Charge for different constituents depending on the ultimate use to which water will be put. The water shall be treated as bad quality water when the quality of water is such that a for anyone of the three parameters viz electrical conductivity, residual sodium carbonate or boron is of a higher value than indicated below:

S. No.	Soil Texture	Electrical Conductivity Micro mho/cm at 25° C	Residual Sodium Carbonate in ppm	Boron in ppm
(i)	Clay	2000	5	2
(ii)	Clay Loam	3000	5	2
(iii)	Loam	4000	5	2
(iv)	Sandy Loam	6000	5	2
(v)	Sandy	8000	5	2

**41.16 Record of Chemical analysis of Water And Details of Development and Test Report.**

The following information shall be furnished by the testing agency to the Engineer - in - Charge on completion of testing of the tubewell:

- (a) Results of the tubewell depth and water level measurements,
- (b) Report on the chemical analysis of water, and
- (c) Results of development and drawdown test as given in Appendix-IV.

**41.17 DISINFECTION**

**41.17.1** The well shall be disinfected as per requirement, after completion of test for yield. All the exterior parts of the pump coming in contact with the water shall be thoroughly cleaned and dusted with powdered chlorine compound. In fact it should be disinfected every time a new pump is installed or the one replaced after repairs.

**41.17.2** A stock solution of chlorine may be prepared by dissolving fresh chlorinated lime. For obtaining an applied standard concentration of 50 ppm, 1 litre of the stock solution shall be used to treat 300 litres of water.

**41.18 GROUTING AND SEALING**

Grouting and sealing of tubewell may be done, if required depending upon the quality of water in the saline zone.

**41.19 PUMP INSTALLATION**

Materials to be used shall be as per 41.3.10. Motor and pump should be installed as per manufacturer's recommendations. At the end of discharge pipe after bend the sluice valve and reflux (non return) valve should be fitted for regulation of discharge and providing safety of pump and motor from back thrust of water when stopped respectively. The motor cable is then connected properly with irrigation panel, which should have the specification as per para 41.3.13.

**41.20 HANDING OVER OF THE TUBEWELL BY THE DRILLING AGENCY**

**41.20.1** The housing pipe shall be closed by a well cap for the period between the completion of the tubewell and the installation of the pump set.

**41.20.2** The following information shall be maintained on completion of the tubewell.

- (a) Strata chart of the tubewell indicating the different types of soil / strata met with at different depths;
- (b) Samples of strata collected neatly packed and correctly marked in sample bags;
- (c) Chart of actual pipe assembly lowered indicating the size of pipes, depth ranges, where slotted/strainer pipes have been used, depth and diameter of housing pipe reduced level of the top of the housing pipe and the diameter and depth of the bore hole;**
- (d) Position of every joint in the well assembly;
- (e) Hours of development done by compressed air, pump sets or by other means; and
- (f) Pumping water level at the developed discharge.

**41.20.2.1** *A typical proforma is given below to furnish the details given in para 41.20.2*

**INFORMATION TO BE FURNISHED BY THE DRILLING AGENCY TO ENGINEER - IN - CHARGE ON COMPLETION OF TUBEWELL**

1. Agency drilling the tubewell.....
2. Location of the tube well.....
3. Method of drilling adopted.....
4. Date of starting.....
5. Date of completion.....
6. Pilot hole or test hole.....Bit size.....Bit type.....Hours .....
- From..... ..To
- .....
7. Coring done.....Bit size .....Bit type..... Hours.....Recovery.....
- From..... ..To .....
8. Reaming.....Bit size ..... Bit type.....
- .....Hours.....
- From..... ..To
- .....

9. Lithological data

From	To	Formation
.....	.....	.....
.....	.....	.....
.....	.....	.....

**Assembly of Production well .....Size.....Length.....Type**  
.....

Perforation per meter.....

Housing pipe.....

Blind pipe.....

Strainer.....

Bail plug.....

11. Top of tube well above / below ground level.....

12. Size of gravel.....Quantity used before development.....

Quantity used during development.....

13. Method used for development.....Total hours of testing.....

14. Further details appended:

(a) Samples of strata, neatly packed in sample bags.....

(b) Chart of pipe assembly lowered .....

(c) Results of mechanical analysis of.....

samples of unconsolidated strata.

15. Remarks:

Engineer - in - Charge

Driller

(On behalf of the Drilling Agency)

## APPENDIX-I SELECTION OF SLOT SIZE

**1. Determination of slot Size** - The size of slot openings suitable for different formations shall be based on sieve analysis of the aquifer material. Following procedure and design criterion is laid down for general guidance.

A weighed quantity of the thoroughly mixed sample is passed through a set of Indian standard sieves nom No.75 onwards. The sieves are arranged such that the coarsest sieve is placed at the top and the finest at the bottom. After proper shaking, the sieve set is opened and material retained on each sieve is correctly weighed. The weight passing through each sieve is plotted on semi logarithmic graph paper having percentage weight as ordinate on arithmetic scale and size of the sieve opening as abscissa on logarithmic scale. A smooth graph is then drawn through the points.

**2. Aquifer Material Classification** - The aquifer material may be classified into various categories according to the following ranges of the particle size :

Fine gravel	above 2.0mm
Coarse sand	0.5 to 2.0mm
Medium sand	0.25 mm to 0.5 mm
Fine sand	0.05 mm to 0.25 mm
Silt	0.002 mm to 0.05 mm
Clay	below 0.002 mm

Grain size curves of a few typical aquifer materials covering fine to coarse sand are shown in figure below:

Diameter In Millimeters  
Typical Grain Size Distribution Curves (U.S.B.R. Classification)



**2.1 Effective Diameter -** The effective diameter is an index of the measure of the fineness of an aquifers. For permeability, is generally taken as the effective size

**2.2 Uniformity Co-efficient -** Uniformity co-efficient gives the slope of the major portion of the grain size distribution curve and is defined as below:.

$$C_u = \frac{d_{60} \text{ (40 percent retained)}}{d_{10} \text{ (90 percent retained)}}$$

**3. Gravel Pack -** Criteria for design of artificial gravel pack is generally expressed in terms of gravel pack ratio which is defined as the ratio between the average size of the gravel pack material and the average size of the aquifer material. However following design criteria for gravel pack is recommended based on minimum head loss through gravel pack and minimum sand movement.

#### **Pack-Aquifer Ratio**

(i) Uniform aquifer with uniform gravel pack 9 : 12.5

(ii) Non-uniform aquifer with uniform gravel pack 11: 15.5

The above criteria is based on minimum head loss through gravel pack and minimum sand movement.

In case gravel pack has to be provided to a well where more than one formation are to be tapped, the gravel pack designed for the finest formations should be provided for all the formations, provided average grain size of the material in the coarsest aquifer is less than 4 times the 50 percent size of the material in the finest aquifer.

To avoid trouble in placing and irrespective of gradation, packs should not contain particles greater than 13mm

The size of the slot opening is governed by the size of gravel or aquifer material which it has to retain. The slot size for gravel packed well should be such that it retains about 90 Percent of the gravel.

## APPENDIX - II

## METHODS OF DEVELOPMENT

1. **Development by Overpumping** - The simplest and the most common method of removing fines where a well ends in sand or gravel is by over pumping. It means pumping the well at a higher capacity than it will be pumped when in regular service. It is quite convincing if a well can stand a discharge of 2280 LPM during over pumping, will naturally stand a discharge of 1380 LPM in regular service and will provide water free of sand. But there are three main objections to this method of development:

(a) Over pumping will not generally develop maximum efficiency in the wells,  
**(b) It tends to cause sand to "Bridging Action" in addition to clogging of the gravel pack if used,**

(c) It often requires use of larger pumping equipment than conveniently available.  
 By over pumping a tubular flow is created in the formation, fines are removed with greater speed but it does not assure greater permeability as can be achieved by other methods. Thus so called maximum efficiency is not obtained.

"Bridging" of sand in water bearing formations is a very important factor. When the water is pumped out of the well, there is a tendency to move the sand in the direction of the well end, with a steady pull in one direction, the finer sand grains wedge against each other and bridge across the openings between coarser grains of the gravel pack of the screen. The only way to avoid bridging is to provide agitation in movement of water.

Wells with small yields can easily be developed by over pumping but where a large quantity of water is required to be pumped, over pumping is not practicable.

2. **Development with Compressed Air** - There are two general methods of applying compressed air for the development of wells :

- (a) Back washing method, and
- (b) Open wells, or surging and pumping method.

The principle of back washing with compressed air is to force the water of the well through the screen, into the water bearing formation. The air is introduced into the well through the top of the casing after it has been closed. In order to prevent the possibility of air locking the formation, provisions has to be made to prevent the air from

entering into the formation. This can be achieved by terminating the drop pipe above the well screen. A point of relief is also provided for the air introduced into the casing.

The principle of this method is a combination of surging and pumping by means of sudden release of large volumes of air, a strong surge is produced by virtue of the resistance of water head friction and inertia. Pumping is done with an ordinary air lift pump. This is the most popular and suitable method of development used by many drillers. To do the job, an air lift is done with the air pipe provided inside an educator pipe (Pumping pipe) in the well. The equipment needed for this method includes the following:

- (a) Air compressor and air tank,
- (b) Pumping pipe and air line in the well, with means for raising and lowering each independently of the other,**
- (c) Flexible, high pressure, air hose to permit raising and lowering of the air line in the well,
- (d) Pressure gauge and relief valve to safeguard against accidental loading ,
- (e) Quick opening valve in the outlet of the air tank for controlling air flow.

The outlet of the compressor should be connected to the air tank in a way which will minimize resistance to air flow. The outlet pipe leading from the tank to the well should be larger than air line in the well.

The drop or pumping pipe is handled by the drilling line while the air line is handled separately by another line.

The table below gives the recommended sizes of Pumping or educator drop pipe and air line to be used for various sizes of wells.

Pumping Rate in LPM	Size of well casing in cm	State of pumping pipe in cm	Size of air line in cm
113 – 226	10	5	1.25
226 – 302	12.5	7.5	2.50
302 – 378	15	8.25 to 10	2.50
378 – 567	15	10	3.75
567 – 945	20	12.5	3.75
945 - 1512	20	15	5.00

Air development produces best results, when the submergence ratio of the air line is about 60%. Submergence ratio is the ratio of the total length of air line to the air pipe below the water while pumping, that is pumping level. If for example, the air line is 55 m long and the static water level is 19 m below ground, the submerged length is 36 m. Therefore non-pumping submergence ratio is  $19/55 = 0.65$  or 65%. If the air lift is started and water level drops to 23 m below ground, the submerged length becomes 32 m and the submergence ratio while pumping will be  $23/55 = 0.42$  or 42%.

Reasonably good results can be obtained by a skillful operator with submergence as low as 30% while pumping.

In using air for development the drop pipe is lowered about 0.6m below the bottom of the well. The air line is placed such that it is 0.3 m or 0.6 m up in the drop pipe. The compressed air is turned into the air line and the well is pumped in a regular manner of an air lift until water appears to be free of sand. The valve on the air line is then closed, allowing the pressure in the tank to build up to 7 or 10.5 kg / sq cm. In the meantime the air line is lowered so that it is 30 mm or so below the drop pipe. The valve is then opened quickly allowing the air to rush into the well under full pressure. There will be a forceful surge of water though brief and if the air line is then pulled back in to the drop pipe the strong reverse flow will be produced, up the drop pipe thereby effectively agitating the water bearing formation.

The well is then pumped as an air lift for a short time, and another head of air is released with the air line below the drop pipe and the air line is again lifted to resume pumping. The cycle of surging and pumping is continued, until the water is free from sand indicating that development is completed in the region near the bottom of the air lift.

The air lift assembly is then raised to a position about 30 mm higher and the same surging operations are repeated. In this way the entire length of the screen is developed. At the end the assembly should finally be lowered to its original position near the bottom of the well and operated in order to clean out any sand that has accumulated at the bottom levels.

**Limitation of Method:**

When used correctly under proper conditions and with adequate equipment, this method of development is very effective and rapid. There is a little chance of development being over done but where the yield is very low and the draw down is rapid, or where submergence is low, the compressor method is of no use and should resort to over pumping method.

APPENDIX - III

VERTICALITY TEST REPORT

Name ..... of I.D. .... of  
 work:..... Well.....mm  
 Pump Serial O.D. .... of  
 No..... Disc.....mm  
 Conducted Disc  
 by..... Correction.....  
 mm  
 In the Presence Point ..... of  
 of..... Suspension.....m  
 above  
 Date..... Static ..... Top of Well  
 ..... level.....m Water  
 Depth of Well  
 Housing.....m

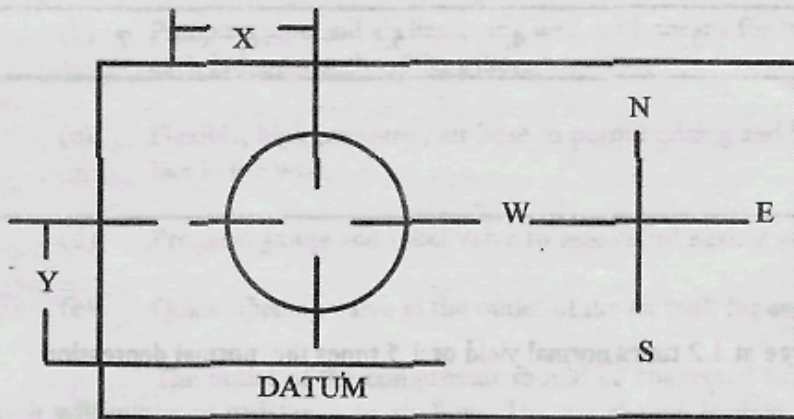

Depth in m Below Top of Tubewell	Readings from Arbitrary Datum		Deviation from vertical at Top of Tubewell				Calculated Devia- tion from vertical at Respective Depth				Calculated Devia- tion from vertical at Respective Depth Adding Disc Correction				Resultant Deviation Remarks and its Direction
	X	Y	N	S	E	W	N	S	E	W	N	S	E	W	

Signature of Engineer - in - Charge ..... Signature of Tester .....

**APPENDIX - IV**  
**TEST RESULTS**

A. Normal Test

Sl No.	Rated Discharge	Depression at Rated Discharge	Specific Yield (2/3)	Total Hours Run	Sand in ppm at End of Test	Static Water Level	Pumping water Level
1	2	3	4	5	6	7	8

B. Discharge at 1.2 times normal yield or 1.5 times the normal depression

Specific Yield Discharge Draw Down	Total Hours Run	Sand in ppm at End of test	Static Water Level	Pumping water level
1	2	3	4	5

A Typical proforma is given below to furnish the details of A and B above

**Typical Proforma**

1. Agency Conducting the tests .....
2. Location of tubewell .....
3. Date of Starting .....
4. Date of completion .....
5. Total depth of tubewell .....
- Method adopted.....
6. Depth of Water level.....
7. Results of verticality and .....  
alignment test
8. Drawdown test; Time of test.....  
Speed rev/min..... discharge..... Period run .....
9. Rated discharge in lt/min.....
10. Depression head of the production well . .....
11. Sand contents in ppm at the rated discharge after 20 minutes of the start of the pump or 20 percent in excess of the rated discharge if 50 percent in excess of the rated discharge if 50 percent extra depression con not be arranged.....
12. Recommendation with regard to a suitable pump .....
13. Further details appended . .....  
Chemical and bacteriological analysis of tube well water .....
14. Remarks.....

---

Engineer - in - Chief

---

Tester (on behalf of the  
**testing agency)**

When the well is developed both by air (i.e. through compressed air pumping) and pumping (i.s. over pumping) ; then it should be tested to determine its 'yield' and 'drawdown' This information provides a basis of pump.

The tubewell is tested for the yield by pumping out water from the well by a pump of a capacity higher than the expected yield of tubewell. Procedure is simple and generally known as "Set Draw Down Test" of an equifer under consideration. A simple arrangement is needed. A pump, capable of delivering higher discharge than the expected discharge from the well, is employed. On the discharge we, a regulaing valve is provided. Testing starts by allowing a limited discharge for atleast half an hour, and the corresponding stable draw-down is noted. Let us call this first set of reading as 'Q1' at 'D1' for discharge and drawdown. By allowing a little more discharge, on stable formation of water level the drawdown is noted (Q2 & D2) . Like wise, Q is increased further and Draw-down are noted. Test is conducted beyond the expected discharge and with these set of readings, a graph is plotted as shown below:-

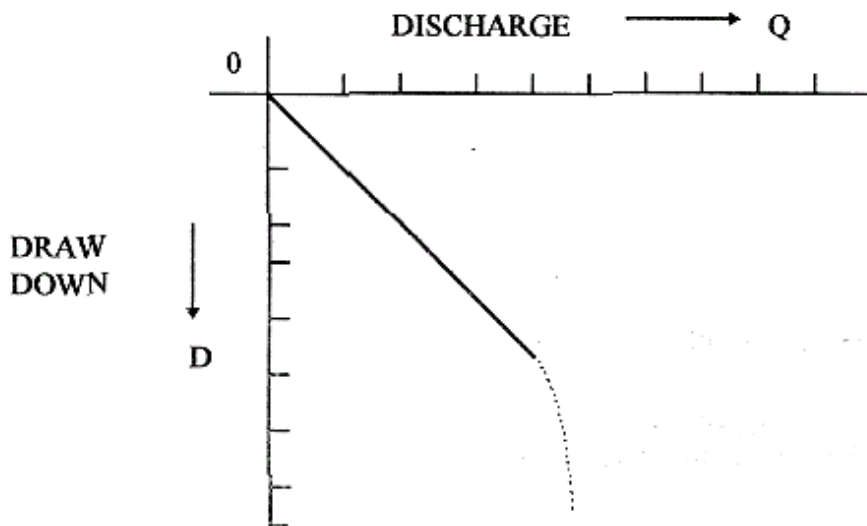

#### CURVE - DISCHARGE VIS DRAW DOWN

On observation of the plot (the graph), one may find that for some range of increasing draw-downs; the corresponding discharges follow a straight line relation. But at some particular point, this relation ceases to be so and the increase in drawdown further does not yield the discharge in the same proportion, but a little less. With this study, the safe discharge is assessed, which is generally a little more than the discharge at which the straight line relationship ceases.



The Directorate of tubewells had laid down, (with the approval of Government of M.P.), some criteria about the discharge and draw-down. A tubewell is considered unsuccessful if the discharge is less than 18,900 LPH (5000 GPH - US) at 6 meter draw-down in alluvium and 9450 LPH (2500 GPH-US) at 12 metres drawn-down in rocky area.

If a tubewell is found unsuccessful at these standard drawdowns, the testing is still continued by increasing the draw-down upto the safe limit. Some unsuccessful tubewells happened to prove successful with the increased drawdown and the cultivators have accepted them.

### Yield test report format

Wett No. .... Name of cultivator ..... Village .....

District..... Tubewell depth of drilling ..... ft(m).....

SWL before pumping is ..... ft.(or m). type of pump unit submersible /

Turbine HP. of the pump ..... HP., Rating, for generator.....

KVA. Pump setting..... ft.below ground level (B.G.L) constant discharge..... (G.P.H) when the drawdown recorded in tubewell

l /M<sup>3</sup>/Hr..... Or in drawdown observation well..... pump

**testing..... date.....**

Total time from..... to.....

S. No.	Time since pumping starts in minutes.	Discharge
--------	---------------------------------------	-----------

Break in pumping if any with reasons.

Recommendations for pump (a) Recommended Yeild..... GPH or M<sup>3</sup>Hr. (b)

Draw-down..... ft or m. (c) Type of pump .....( Submersible / Turbine / Diesel)

(d) HP. pump ..... (e) The depth at which, the pump is to be set B.G.L. in ft. or M.....

Notes : (i) The pump to be used for yield that should be capable of pumping 1.5 times the expected yield.

(ii) The constant continued yield after 10 Hrs. pumping at constant drawdown bo be taken as recommended yield.

Incharge Testing

Dated .....

### Discharge Measurement

Discharge of tubewell as defined in the proceeding paragraph, is measured by the following methods :

(A) Discharge measurement through a 90° 'V' - Notch and computation by the formulae. .

(B) Discharge by orifice method.

(A 1) The standard 'V' Notch 8ITangements are as follows.

(a) The width of approach channel should not be less than 1.22m for head upto 22.9 em and not less than 1.8m for heads up to 45.7cm.

(b) The depth from the appex of notch to the bottom of the channel should be not less than 15.2 em on down stream side and 30.4 cm on up stream side.

(c) The thickness of the lip of the notch should be 1.5mm with the upstream edge perfectly sharp.

**(d) The notch plate to be set vertically and perpendicular to the channel of approach and sides of the notch should be equally inclined to the vertical**

(e) Head to be measured at the side offlume, upstream from the notch; at a distance four times the maximum head to be measured.

If the approach channel is wide as per (a) above, then the velocity of approach, which is not taken into account will result in the calculated discharge to be lower than actual.

The discharge by 90° notch at various heads are tabulated in the following format:

$$(a) \quad \text{Discharge in LPM} \quad = \quad \frac{H^{2.47}}{319}$$

$$(b) \quad \text{Discharge in M}^3/\text{Hr.} \quad = \quad \frac{H^{2.47}}{5320}$$

H	Lit/Min	L/S	M <sup>3</sup> /Hr.
mm			

(A-ii)

The formulae to be used are

$$Q(\text{Cusec}) = 2.54H^{5/2}$$

'H' is height in feet

$$Q(\text{GPH}) = 119 H^{5/2}$$

H - in inches (i.e. Height in inches)

$$Q(\text{LPS}) = 0.0138 H^{5/2} \text{ where 'IT' is height in cm.}$$

These formulae are applicable for a sharp edged 90° V notch cut in a sheet of commercial steel

### B. Discharge by Orifice method

A thin orifice is an opening or aperture through which water is flowing under pressure. Theoretically, water moving towards an orifice or opening with a velocity 'v' is dependent on the pressure or head 'H' in the centre of the opening. The discharge 'Q' is given by  $CA\sqrt{2gh}$ . 'C' being co-efficient of discharge determined experimentally and varies from 0.60 to 0.65. 'A' is the area of orifice in Sq. ft.

Arrangement is shown as below :-

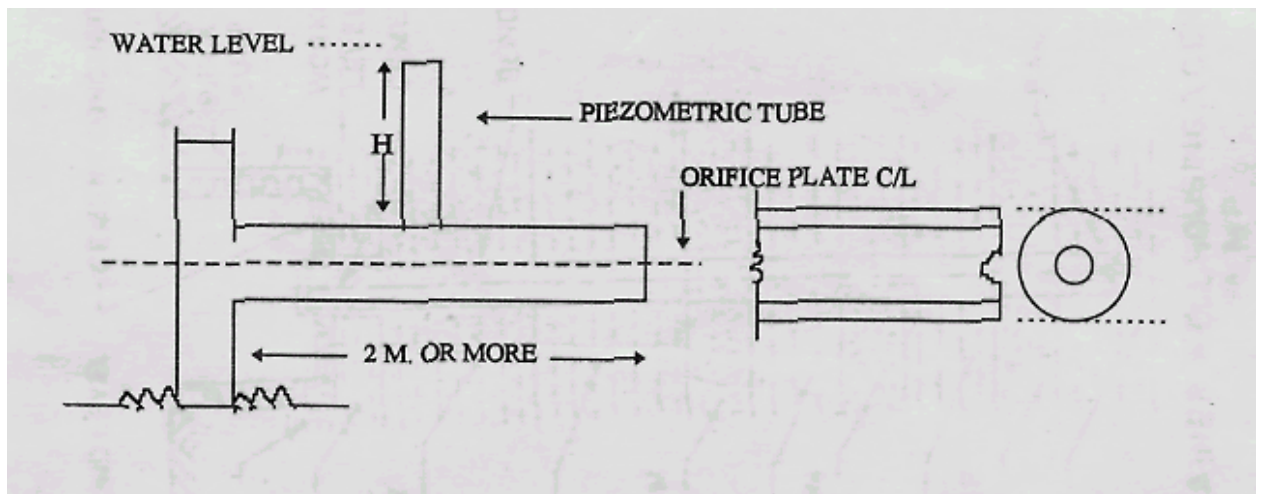

The following precautions are to be taken-

- (i) Piezometric tube should be free from Sand and air or any obstruction.

**(ii) Orifice opening must have sharp, clear edges free from burrs and so arranged that the thin edge is against the flowing stream when it is attached to the discharge pipe.**

- (iii) The fitting of the piezometric tube should not project beyond the inside of the pipe well
- (iv) The device must be kept in horizontal position at all times and the piezometric tube kept in the exact centre or mid position at the Side of the pipe.
- (v) The pressure or head 'H' should be measured only when the orifice is flowing full.

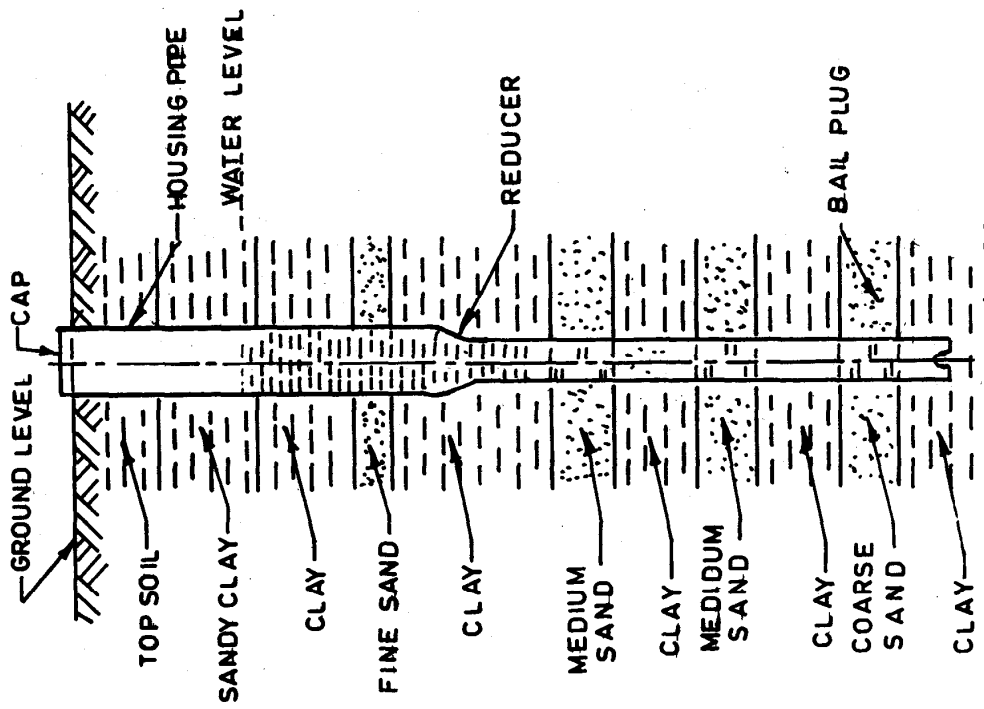

STRAINER WELL NATURAL GRAVAL PACK

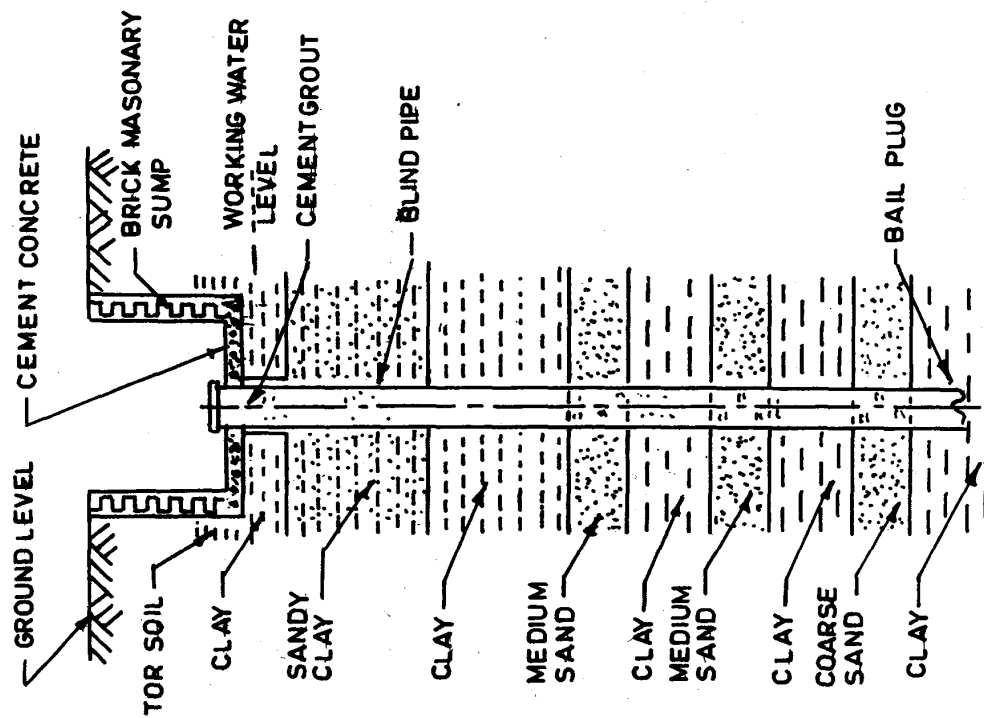

STRAINER WELL HOUSING A CENTRIFUGAL PUMP

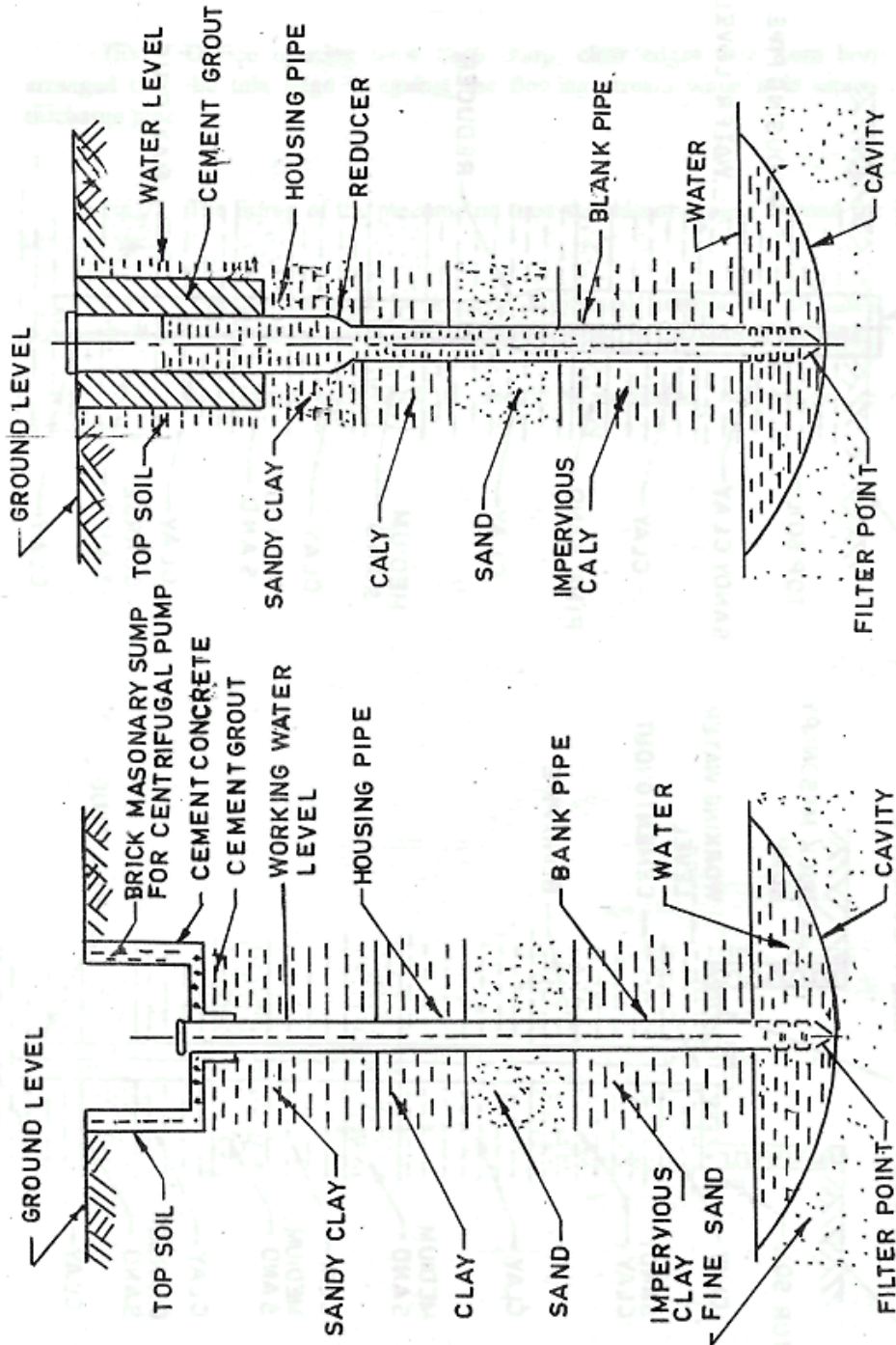

CAVITY WELL FOR TURBOMERSIBLE PUMP

CAVITY WELL FOR CENTRIFUGAL PUMP

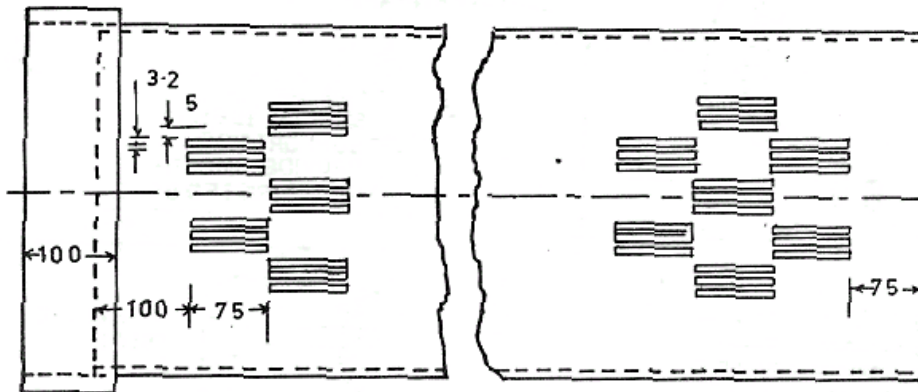

FIG.1 DEVELOPED VIEW OF A TYPICAL WELL SCREEN PLAIN, SLOTTED TYPE

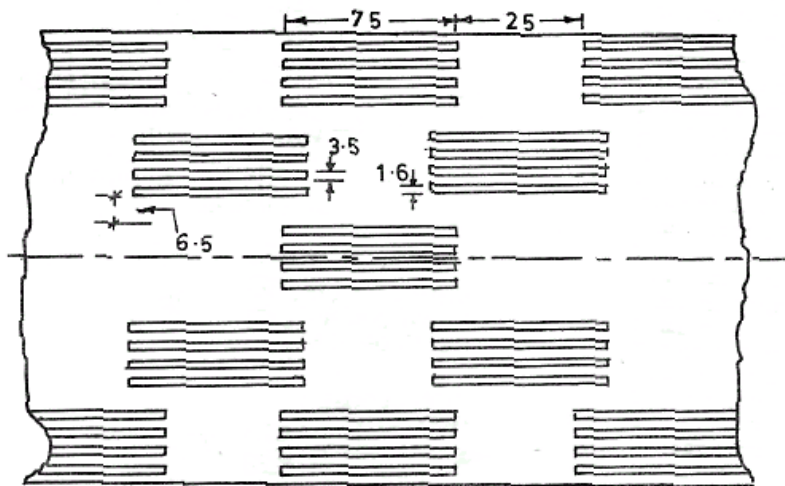

FIG.2 SLOTTING ARRANGEMENT

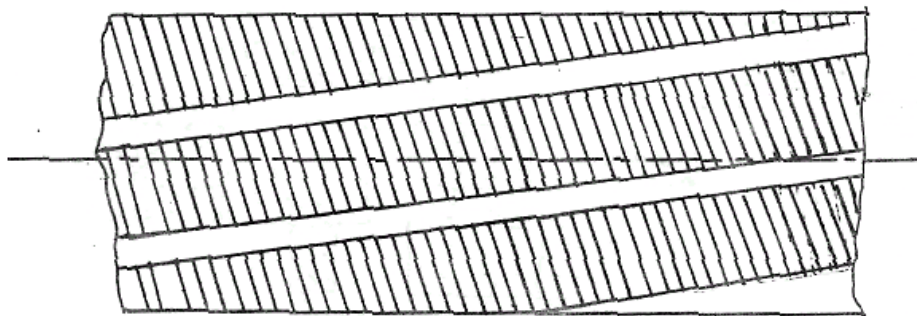
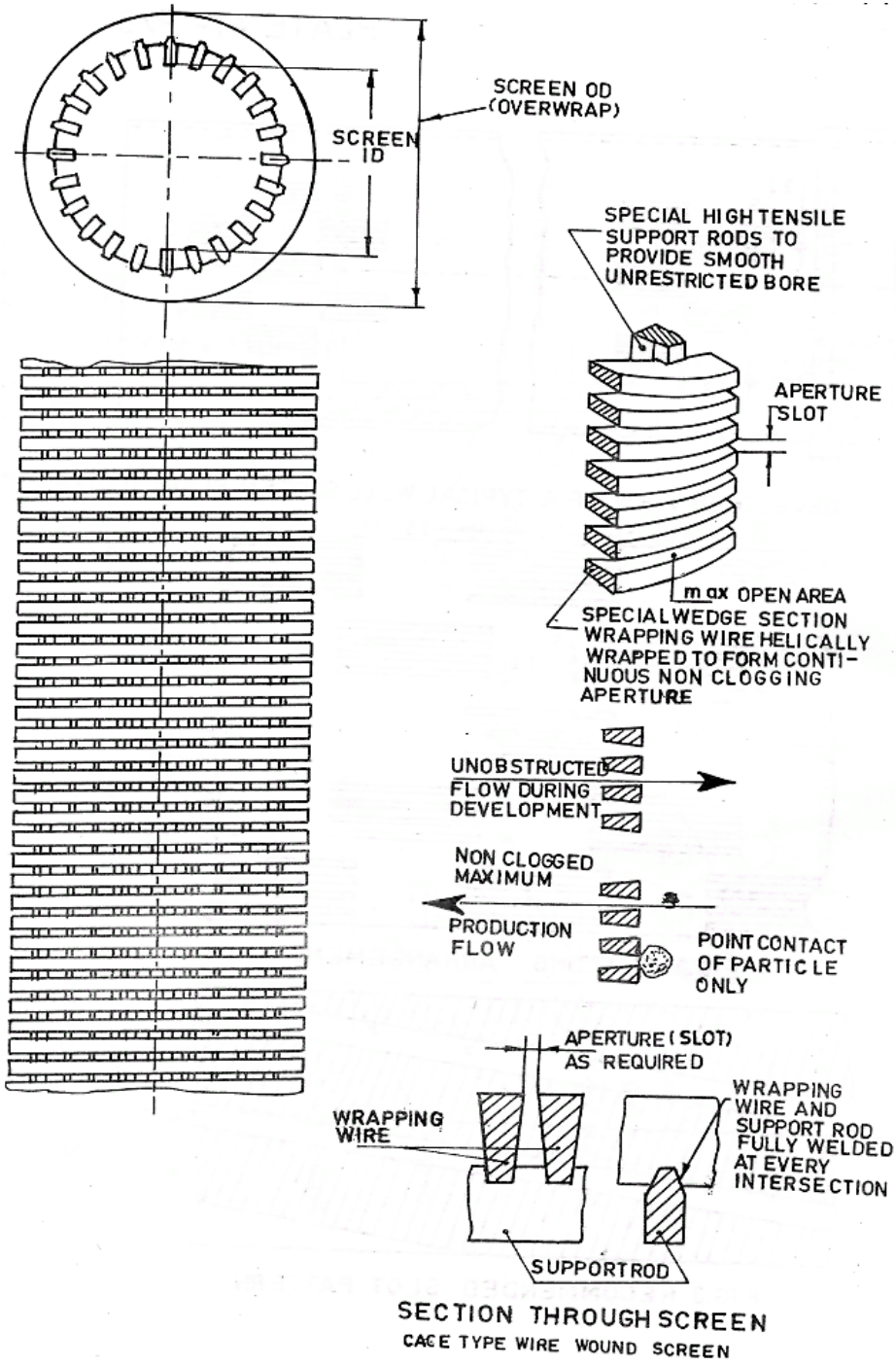
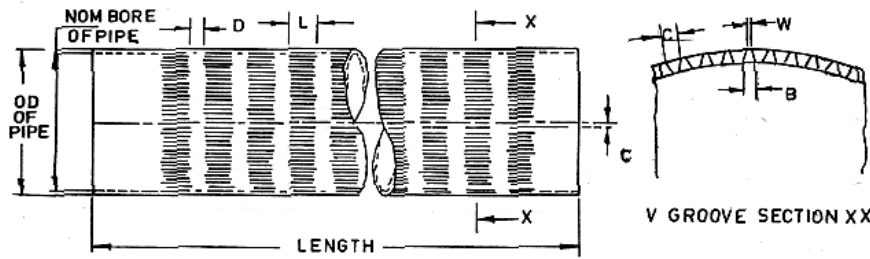

FIG.3 RECOMMENDED SLOT PATTERN







NB of Pipe	OD of Pipe	Sizes of Slots		No of Rows per Metre	Total Slots per Metre	Area of Slots per Metre in m <sup>2</sup>	Water Way Area Percent	B	Distance Between Slots C	Distance Between Rows D
		W	L							
152	162	0.793	40	16	2128	67500.160	13.25	2.778	3.627	19.050
152	162	1.587	40	16	1216	77191.680	15.18	4.762	6.350	19.050
204	213	0.793	40	16	2800	88816.000	13.28	2.778	3.627	19.050
204	213	1.587	40	16	1600	101568.00	15.17	4.762	6.350	19.050

METAL - BRASS SHEETS ACCORDING TO IS:5494-1969 LEADED BRASS SHEETS AND STRIPS FOR USE IN THE MANUFACTURE OF TUBEWELL STRAINERS

All Dimensions in millimetres

FIG 'A'- BRASS SCREENS WITH VERTICAL SLOTS

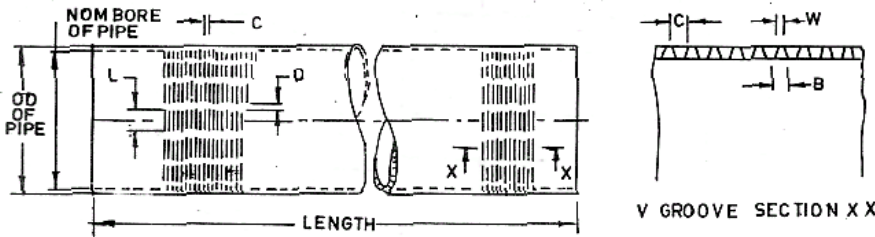

NB of Pipe	OD of Pipe	Sizes of Slots		No of Rows in Dia	Total Slots per Metre	Area of Slots per Metre in m <sup>2</sup>	Water Way Area Percent	B	Distance Between Slots C	Distance Between Rows D
		W	L							
152	162	0.793	30	12	3300	73507.000	15.41	2.778	3.627	9.525
152	162	1.587	30	12	1884	89697.210	17.79	4.762	6.350	19.525
204	213	0.793	30	16	4400	104676.000	15.63	2.770	3.027	11.303
204	213	1.507	30	16	2512	119596.320	17.86	4.762	6.350	11.393

METAL - BRASS SHEETS ACCORDING TO IS:5494-1969 LEADED BRASS SHEETS AND STRIPS FOR USE IN THE MANUFACTURE OF TUBEWELL STRAINERS

All Dimensions in millimetres

FIG. B'- BRASS SCREENS WITH HORIZONTAL SLOTS

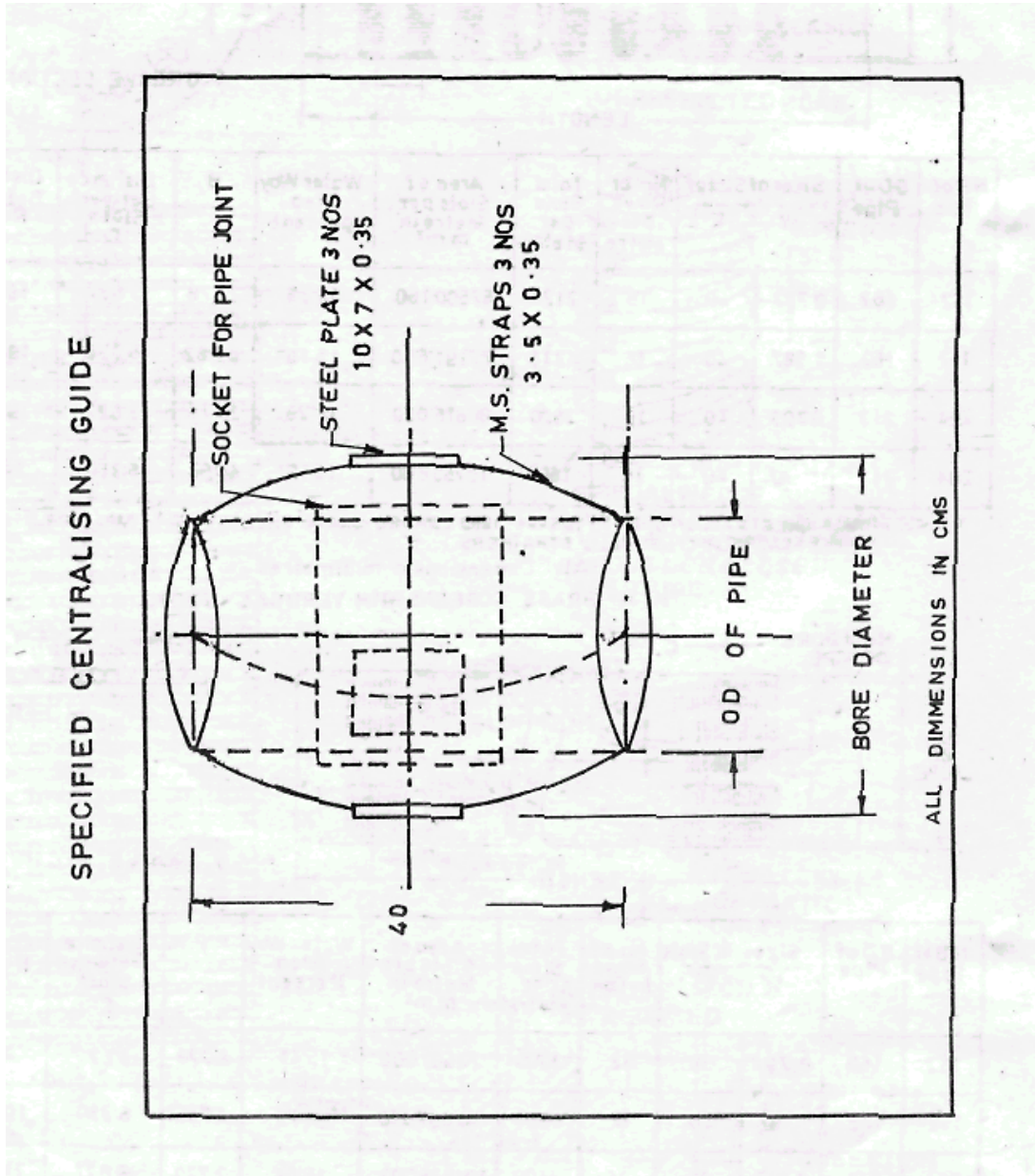

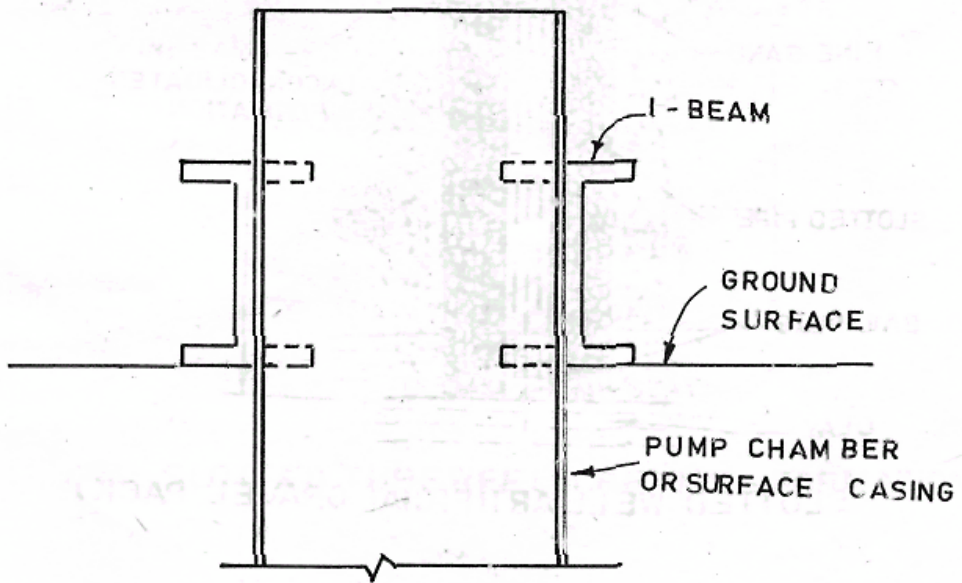
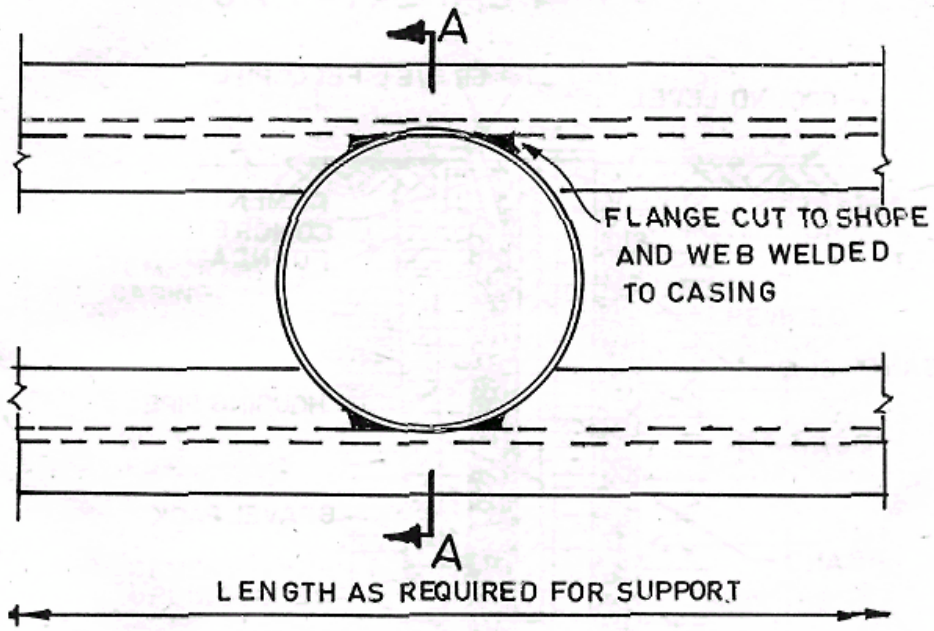

Section A-A

Support of a casing by I beams 103-D-1496

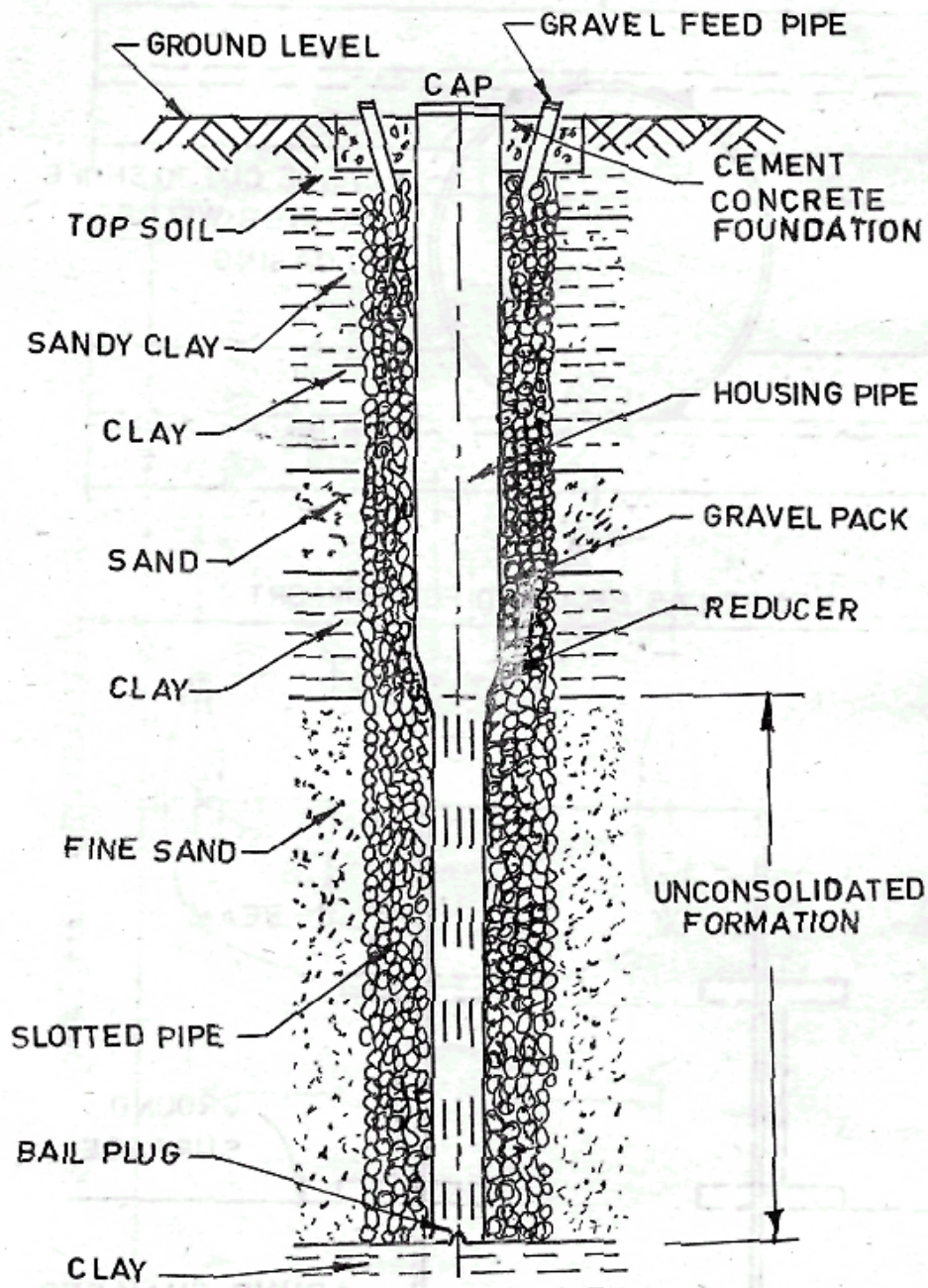

SLOTTED WELL (ARTIFICIAL GRAVEL PACK)

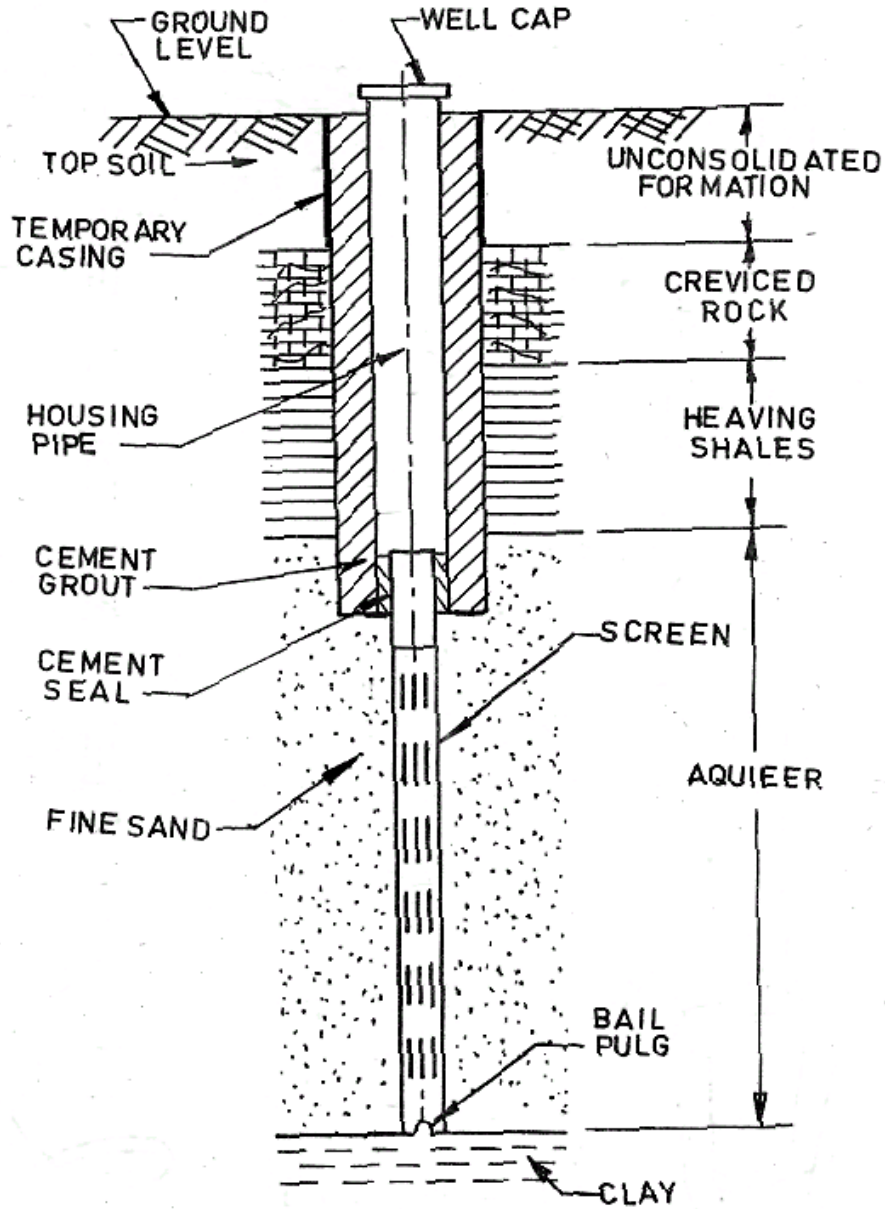

SLOTTED TUBEWELL (CREVICED FORMATION)

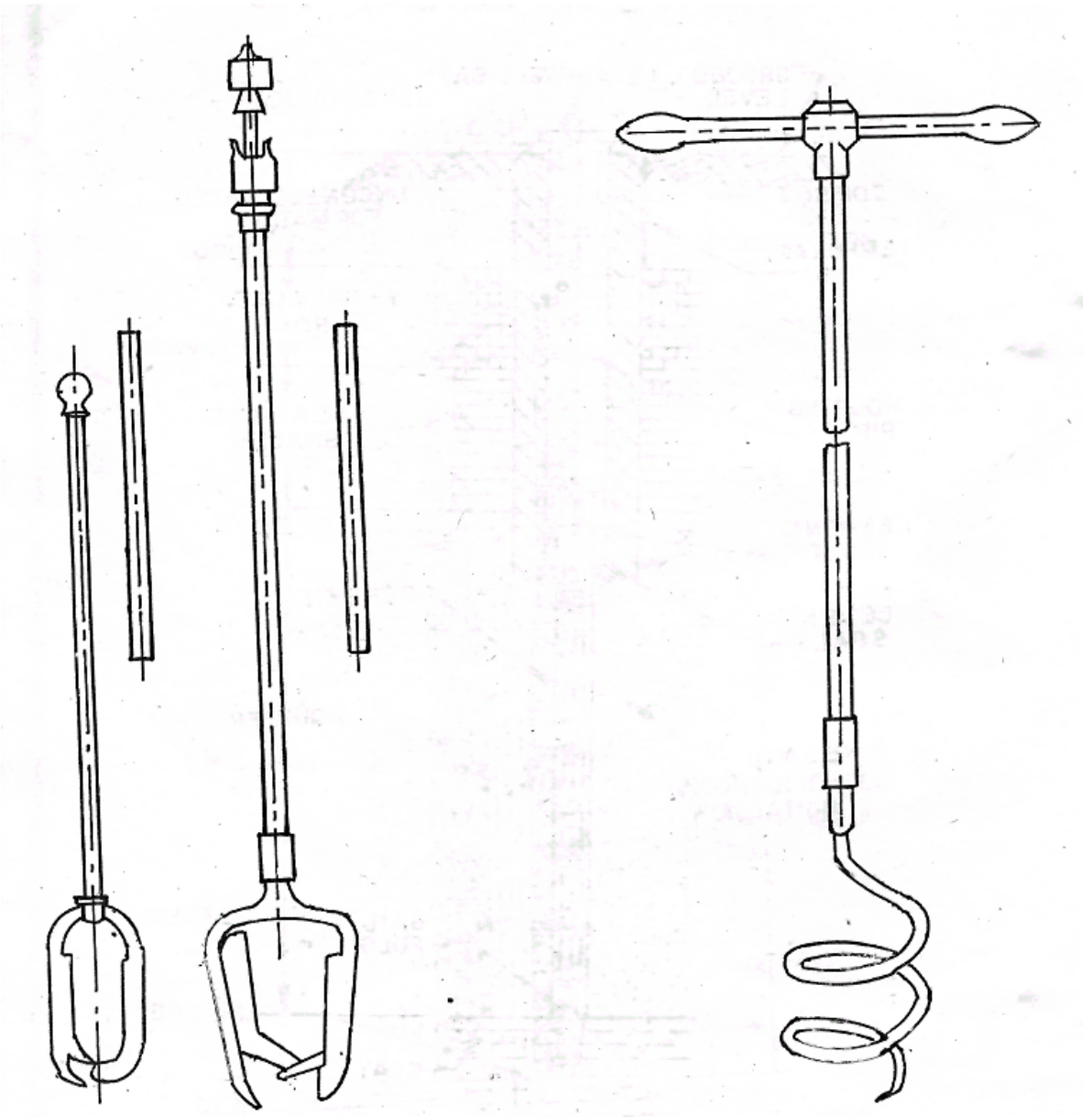

A. HAND AUGER

B. SPIRAL AUGER OR RAM'S HORN

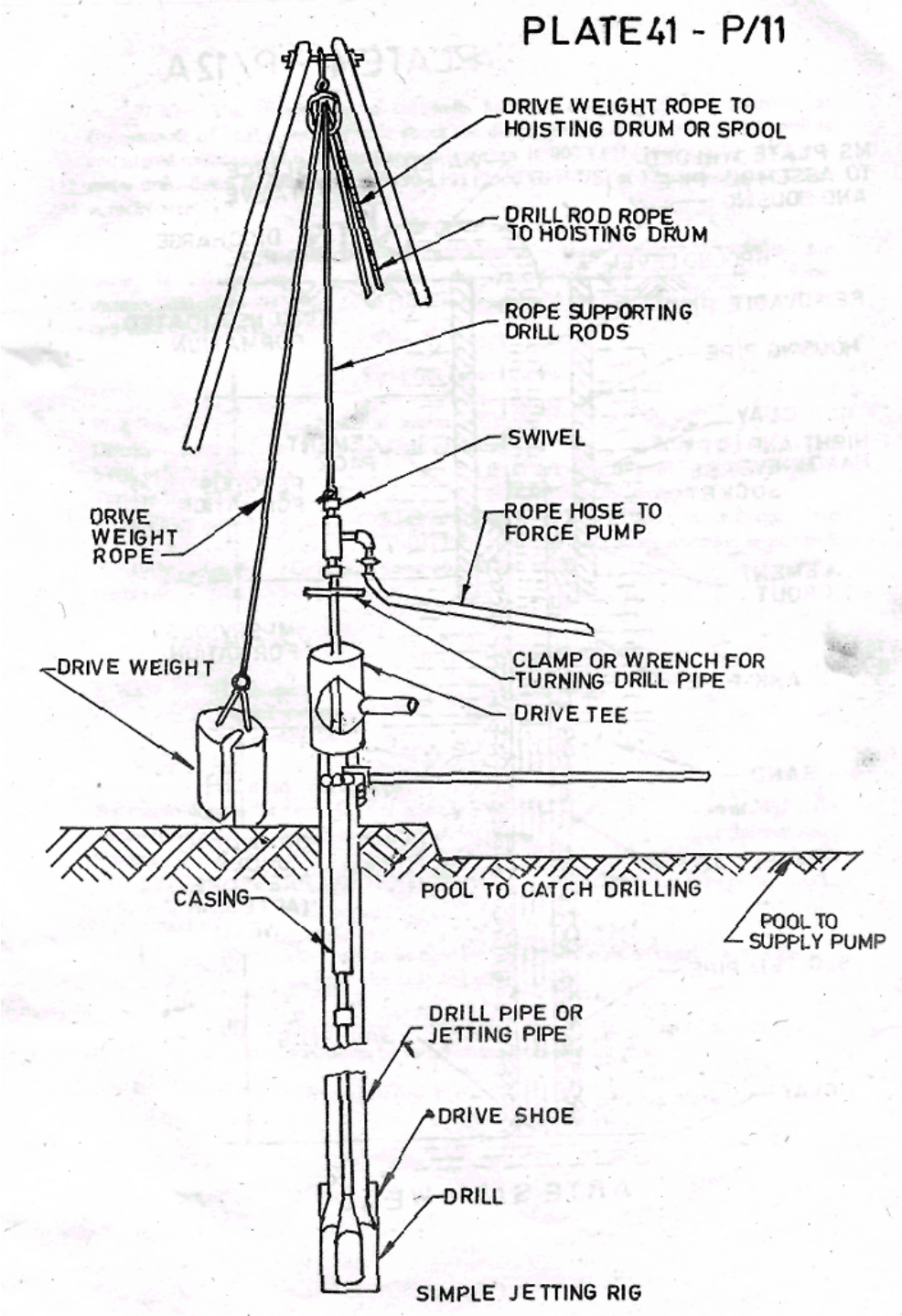

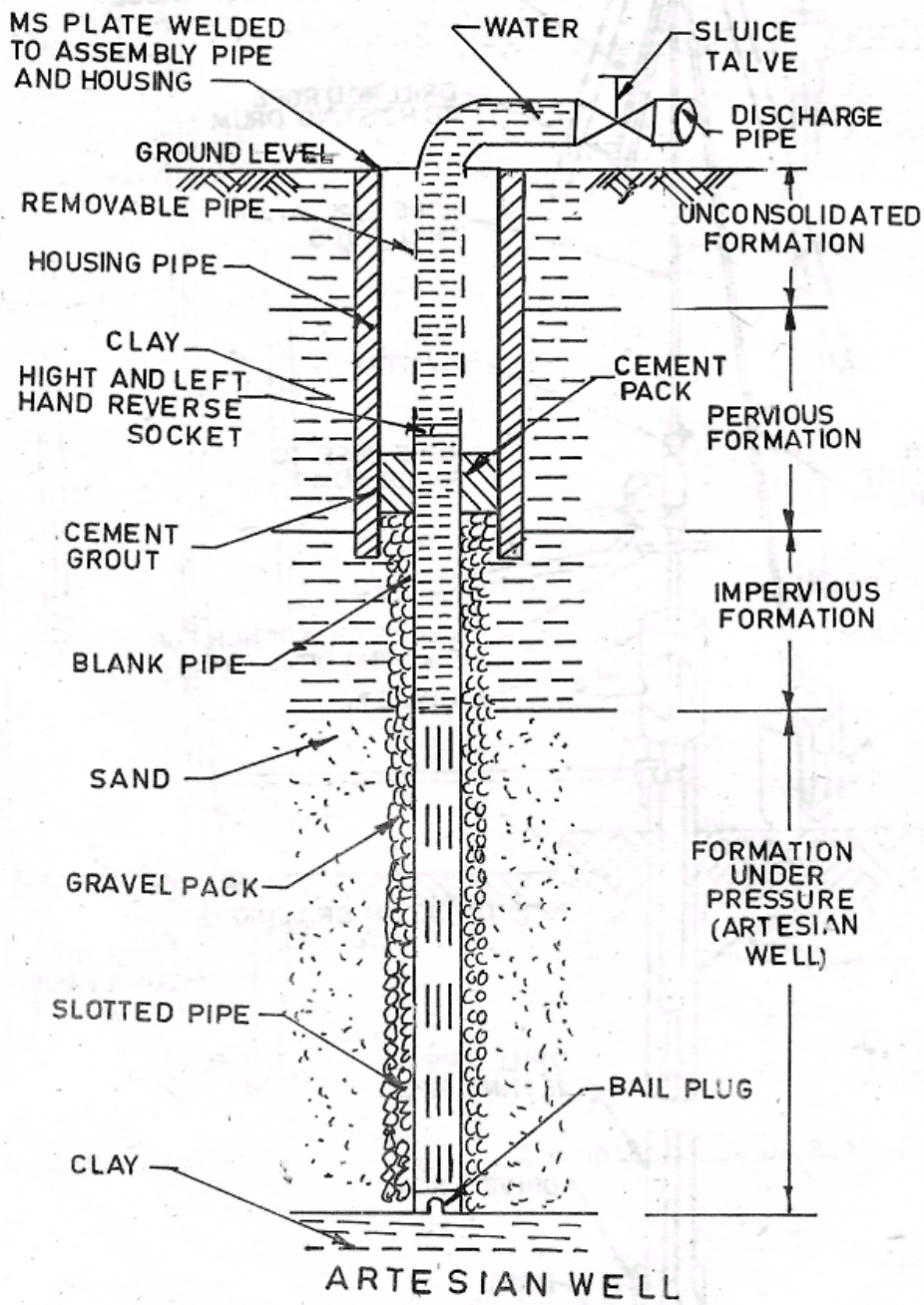



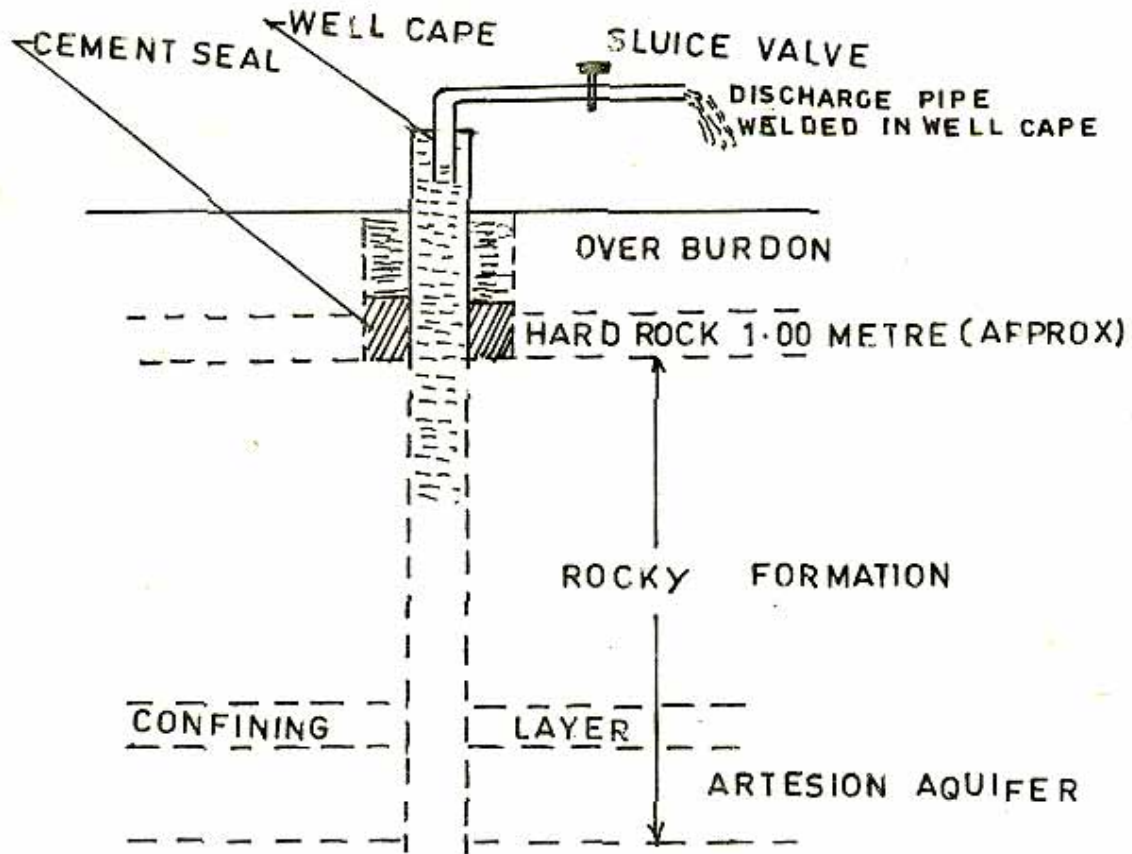

ROCKY ARTESIAN WELL

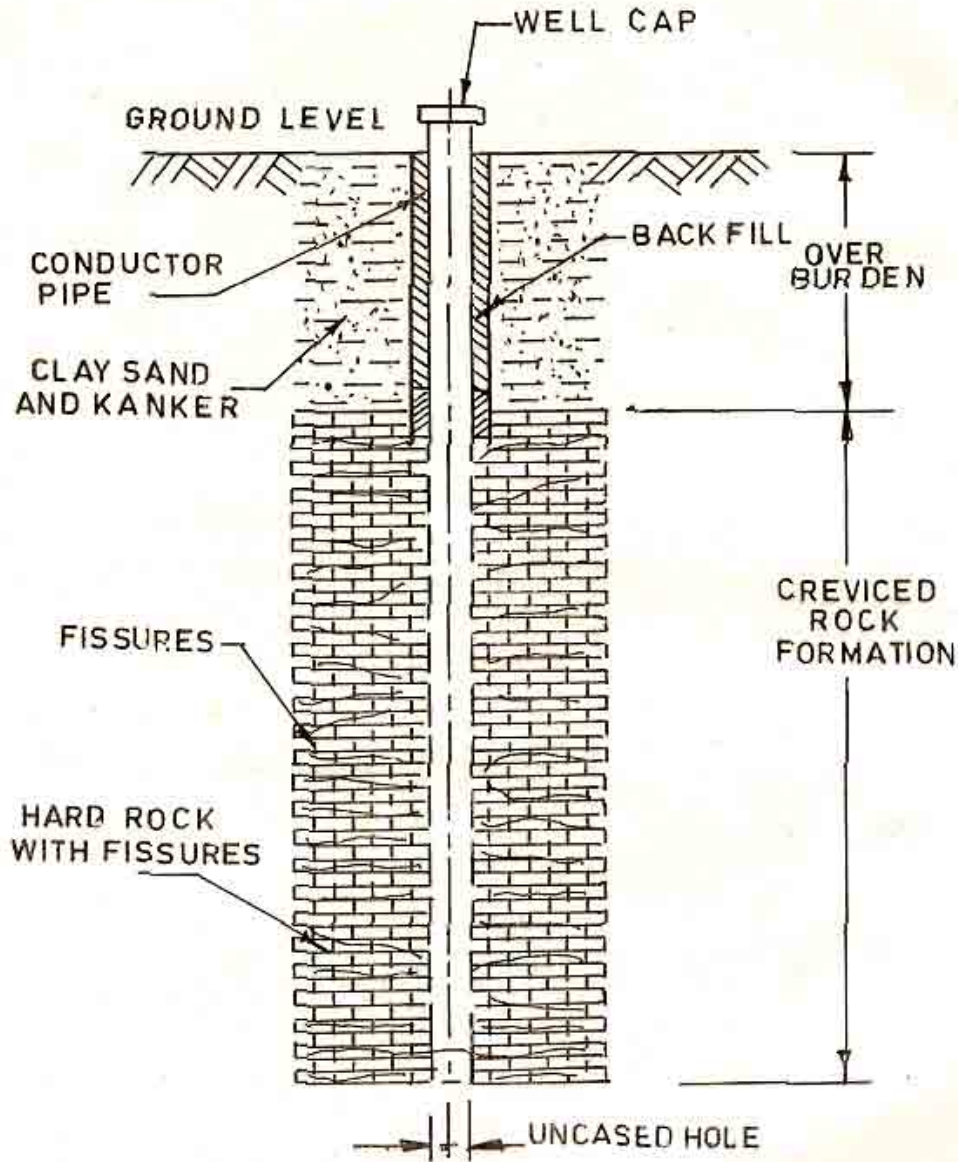

TUBEWELL IN HARD ROCK

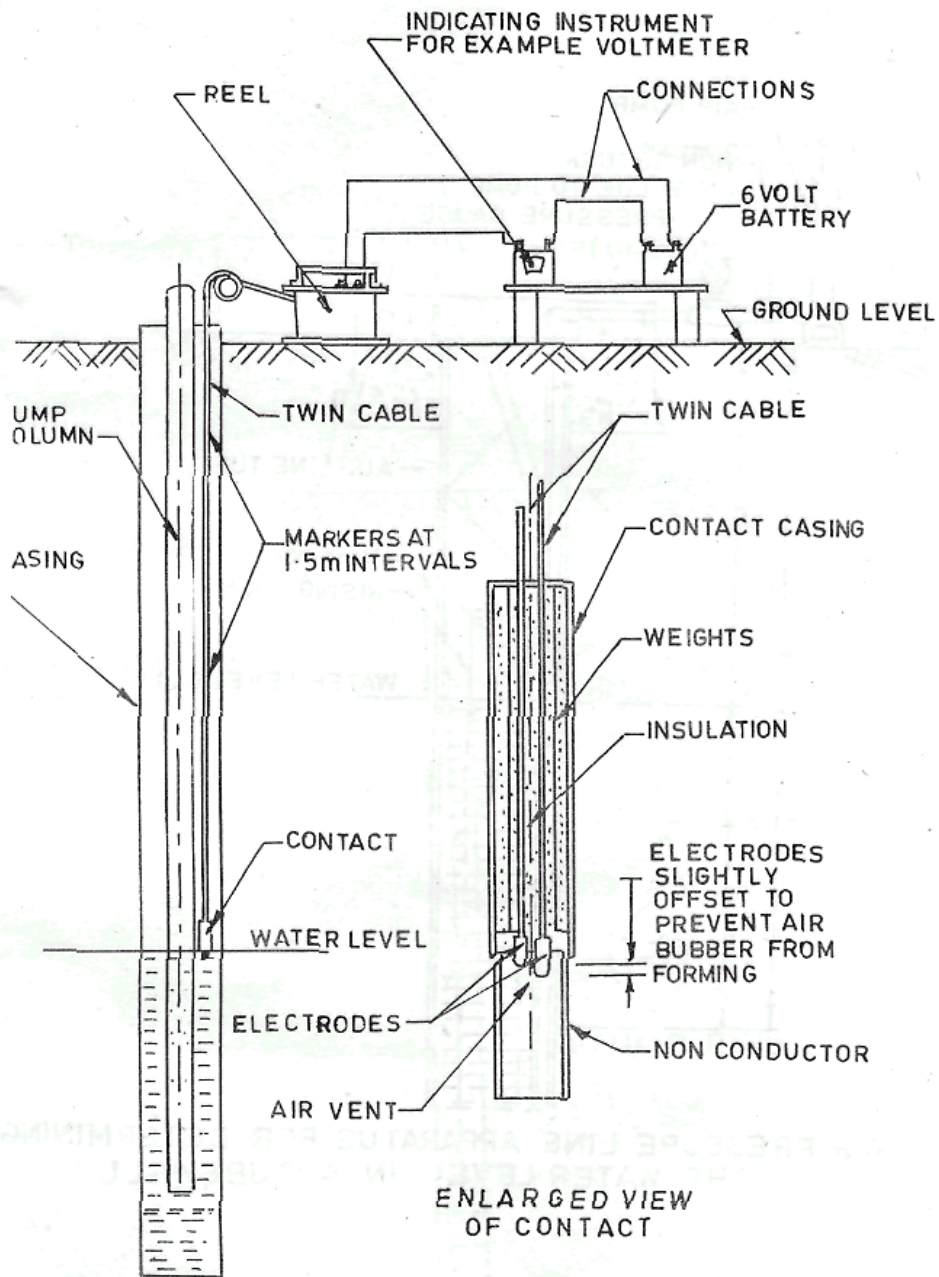

ELECTRICAL APPARATUS WITH DOUBLE POLE CONTACT FOR DETERMINING THE WATER LEVEL IN A TUBEWELL

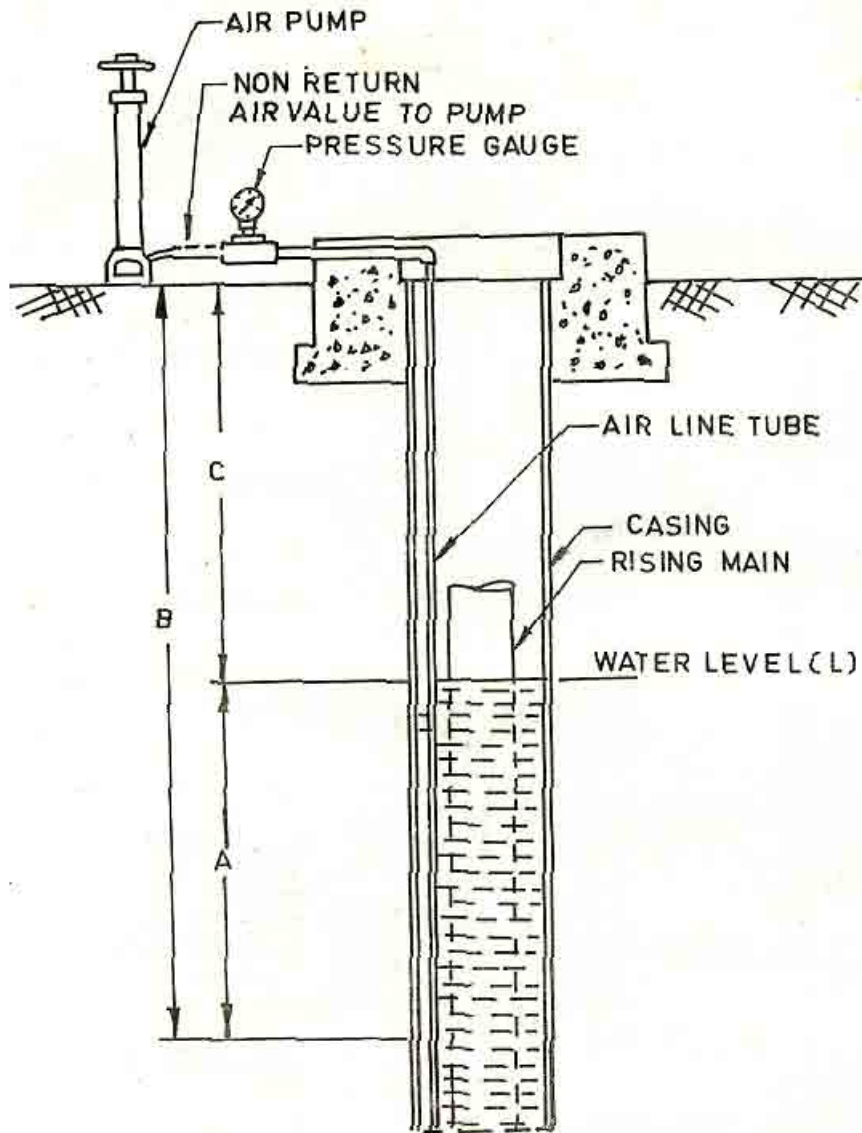

AIR PRESSURE LINE APPARATUS FOR DETERMINING  
THE WATER LEVEL IN A TUBEWELL

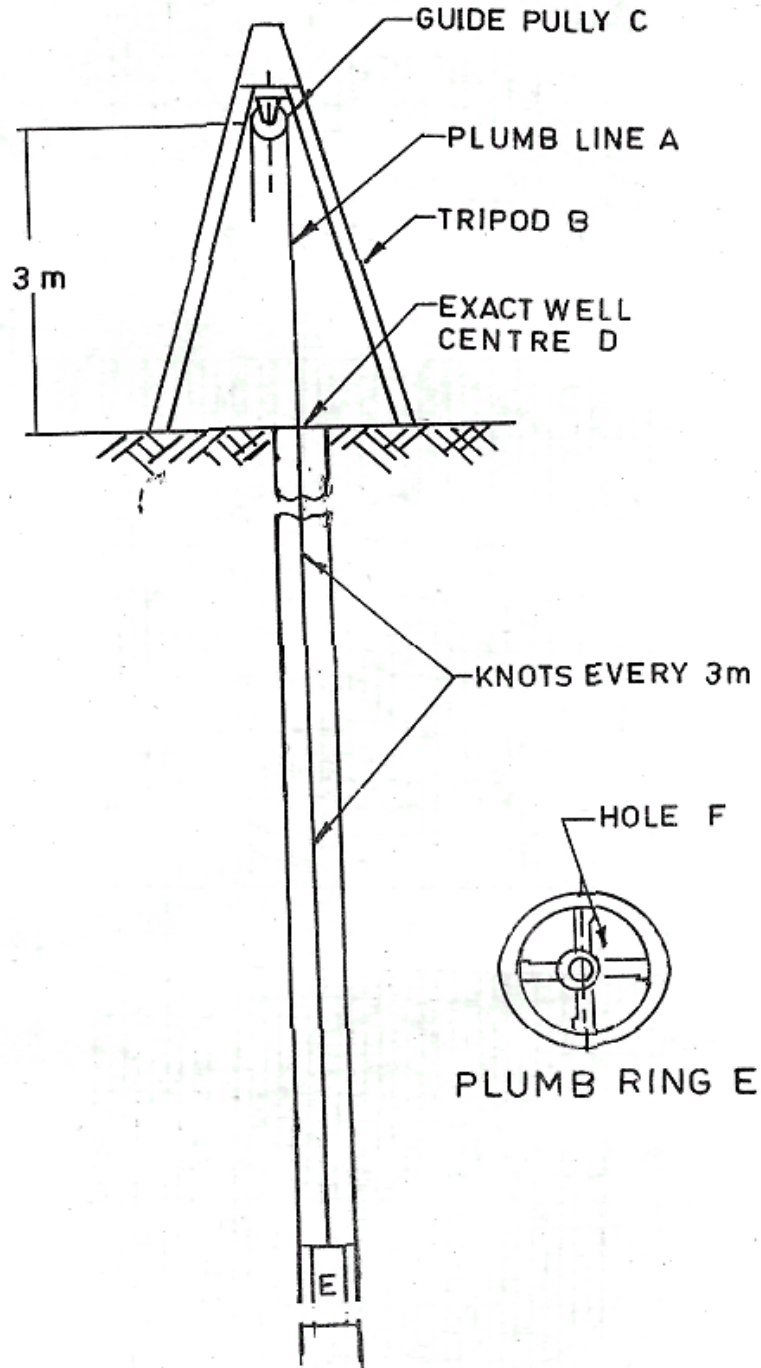

METHOD OF PLUMBING A WELL

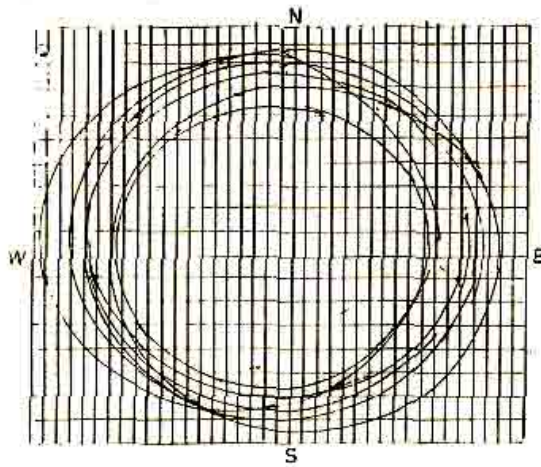

FIG. G 1

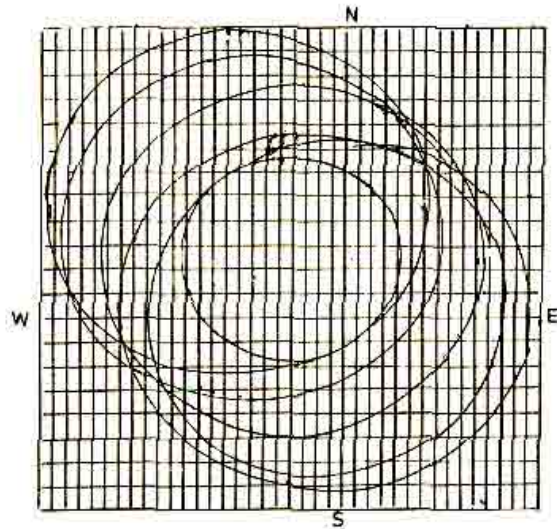

FIG. G 2

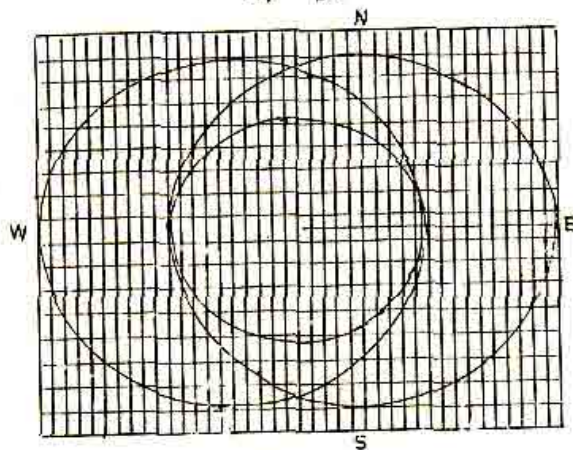

FIG. H

